

TOPOLOGY WITHOUT TEARS¹

Including a graduate course on Topological Groups



SIDNEY A. MORRIS

www.sidneymorris.net

Version of June 28, 2020²

Translations of portions of the 2007 version (or a later version) of this book into Arabic (by Dr Alia Mari Al Nuaimat), Chinese (by Dr Fusheng Bai), Greek (by Dr Kyriakos Papadopoulos), Korean (by Dr Myung Hyun Cho, Dr Junhui Kim, and Dr Mi Ae Moon) Persian (by Dr Asef Nazari Ganjehlou), Russian (by Dr Eldar Hajilarov), Spanish (by Dr Guillermo Pineda-Villavicencio) and Turkish (by Dr Soley Ersoy and Dr Mahmut Akyiğit)

You should ensure that you have the latest version of this book by downloading it only from the site www.topologywithouttears.net.

Note that this book has a large number of worked examples. However, I do not provide solutions to the exercises. This is because it would be quite unhelpful to do so! (Some scammers on the internet are trying to make money by purporting to provide solutions to exercises in this book.)

You learn to do exercises only by doing them yourself.

¹©Copyright 1985-2020. No part of this book may be reproduced by any process without prior written permission from the author.

²This book is being progressively updated and expanded; it is anticipated that there will be about fifteen chapters in all plus appendices. If you discover any errors or you have suggested improvements, please e-mail: morris.sidney@gmail.com.

There is a **Facebook group**, called **Topology Without Tears Readers**, where readers discuss the book and exercises in the book. As of May 2020 there are over 9,200 members.

See <https://www.facebook.com/groups/6378545442>.

The book is supplemented by a number of **YouTube and Youku videos**, which are found from links on www.topologywithouttears.net. As of May 2020 there have been over 57,000 views. You can be informed about new videos by subscribing on YouTube. There are over 1,000 subscribers.

Contents

0	Introduction	5
0.1	Acknowledgments	7
0.2	Readers – Locations and Professions	10
0.3	Readers’ Compliments	11
0.4	Helpful Hint on Hyperlinks	21
0.5	The Author	21
0.6	Credits for Images	22
1	Topological Spaces	24
1.1	Topology	25
1.2	Open Sets	32
1.3	Finite-Closed Topology	39
1.4	Postscript	47
2	The Euclidean Topology	50
2.1	Euclidean Topology	51
2.2	Basis for a Topology	56
2.3	Basis for a Given Topology	63
2.4	Postscript	70
3	Limit Points	72
3.1	Limit Points and Closure	73
3.2	Neighbourhoods	81
3.3	Connectedness	85
3.4	Postscript	88
4	Homeomorphisms	89
4.1	Subspaces	91
4.2	Homeomorphisms	96
4.3	Non-Homeomorphic Spaces	101

4.4	Postscript	109
5	Continuous Mappings	110
5.1	Continuous Mappings	110
5.2	Intermediate Value Theorem	117
5.3	Postscript	123
6	Metric Spaces	124
6.1	Metric Spaces	124
6.2	Convergence of Sequences	141
6.3	Completeness	148
6.4	Contraction Mappings	161
6.5	Baire Spaces	164
6.6	Postscript	173
7	Compactness	175
7.1	Compact Spaces	176
7.2	The Heine-Borel Theorem	180
7.3	Postscript	192
8	Finite Products	193
8.1	The Product Topology	194
8.2	Projections onto Factors of a Product	198
8.3	Tychonoff's Theorem for Finite Products	203
8.4	Products and Connectedness	213
8.5	Fundamental Theorem of Algebra	217
8.6	Postscript	219
9	Countable Products	221
9.1	The Cantor Set	222
9.2	The Product Topology	224
9.3	The Cantor Space and the Hilbert Cube	228
9.4	Urysohn's Theorem	236
9.5	Peano's Theorem	247
9.6	Postscript	254
9.7	Credits for Images	258
10	Tychonoff's Theorem	259
10.1	The Product Topology For All Products	260

10.2	Zorn's Lemma	265
10.3	Tychonoff's Theorem	271
10.4	Stone-Čech Compactification	326
10.5	Postscript	336
10.6	Credit for Images	337
11	Quotient Spaces	338
11.1	Quotient Spaces	338
11.2	Identification Spaces	342
11.3	Möbius Strip, Klein Bottle and Real Projective Space	347
11.4	Postscript	352
11.5	Credit for Images	353
12	The Stone-Weierstrass Theorem	354
12.1	The Weierstrass Approximation Theorem	355
12.2	The Stone-Weierstrass Theorem	373
12.3	Credit for Images	389
	Appendix 1: Infinite Sets	390
	Appendix 2: Topology Personalities	425
	Appendix 3: Chaos Theory and Dynamical Systems	436
	Appendix 4: Hausdorff Dimension	469
	Appendix 5: Topological Groups: A Graduate Course	482
	Appendix 6: Filters and Nets	618
	Bibliography	671
	Index	704

Chapter 0

Introduction

Topology is an important and interesting area of mathematics, the study of which will not only introduce you to new concepts and theorems but also put into context old ones like continuous functions. However, to say just this is to understate the significance of topology. It is so fundamental that its influence is evident in almost every other branch of mathematics. This makes the study of topology relevant to all who aspire to be mathematicians whether their first love is (or will be) algebra, analysis, category theory, chaos, continuum mechanics, dynamics, geometry, industrial mathematics, mathematical biology, mathematical economics, mathematical finance, mathematical modelling, mathematical physics, mathematics of communication, number theory, numerical mathematics, operations research or statistics. (The substantial bibliography at the end of this book suffices to indicate that topology does indeed have relevance to all these areas, and more.) Topological notions like compactness, connectedness and denseness are as basic to mathematicians of today as sets and functions were to those of last century.

Topology has several different branches — general topology (also known as point-set topology), algebraic topology, differential topology and topological algebra — the first, general topology, being the door to the study of the others. I aim in this book to provide a thorough grounding in general topology. Anyone who conscientiously studies about the first ten chapters and solves at least half of the exercises will certainly have such a grounding.

For the reader who has not previously studied an axiomatic branch of mathematics¹ such as abstract algebra, learning to write proofs will be a hurdle. To assist you to learn how to write proofs, in the early chapters I often include an **aside** which does not form part of the proof but outlines the thought process which led to the proof.

¹A useful introduction to Pure Mathematics is my YouTube video, <http://youtu.be/veSbFJFjbzU>.

Asides are indicated in the following manner:

In order to arrive at the proof, I went through this thought process, which might well be called the “discovery” or “experiment phase”.

However, the reader will learn that while discovery or experimentation is often essential, nothing can replace a formal proof.

There is an important difference between the use of “or” in English and in mathematics. In English when you say that statement (a) or statement (b) is true, you usually mean that statement (a) is true or statement (b) is true but not both. In mathematics the meaning is different: the “or” is not exclusive. So it means statement (a) is true or statement (b) is true or statement (a) and statement (b) are both true. For example $x \geq 2$ or $x \leq 2$. In fact $x \leq 2$ and $x \geq 2$ are both true when $x = 2$. This mathematical usage can be misleading at first. For example when we say “Either statement (a) or statement (b) is true” we mean either statement (a) is true or statement (b) is true or they are both true. So remember always that **in mathematics, “or” is not exclusive.**

A recent addition to the Topology Without Tears book is Appendix 5 which contains the material for a first graduate course on topological groups. In particular it contains the beautiful Pontryagin-van Kampen Duality Theorem for locally compact abelian groups and a description of the structure of locally compact abelian groups. I first lectured this course at the University College of North Wales in Bangor in 1974. The Introduction to this Appendix 5 surveys the history of topological group theory and some important material of the last few decades.

This book is typeset using the beautiful typesetting package, T_EX, designed by Donald Knuth. While this is a very clever software package, it is my strong view that, wherever possible, the statement of a result and its entire proof should appear on the same page – this makes it easier for the reader to keep in mind what facts are known, what you are trying to prove, and what has been proved up to this point in a proof. So I do not hesitate to leave a blank half-page (or use subtle T_EX typesetting tricks) if the result will be that the statement of a result and its proof will then be on the one page.

There are many exercises in this book. Only by working through a good number of exercises will you master this course. I have not provided answers to the exercises, and I have no intention of doing so. It is my opinion that there are enough worked

examples and proofs within the text itself, that it is not necessary to provide answers to exercises – indeed it is probably undesirable to do so. Very often I include new concepts in the exercises; the concepts which I consider most important will generally be introduced again in the text.

Harder exercises are indicated by an *.

Readers of this book may wish to communicate with each other regarding difficulties, solutions to exercises, comments on this book, and further reading. To make this easier I have created a Facebook Group called “Topology Without Tears Readers”. You are most welcome to join this Group. Search for the Group, and then from there join the Group.

Finally, I should mention that mathematical advances are best understood when considered in their historical context. This book currently fails to address the historical context sufficiently. For the present I have had to content myself with notes on topology personalities in Appendix 2 - these notes largely being extracted from *The MacTutor History of Mathematics Archive* [390]. The reader is encouraged to visit the website *The MacTutor History of Mathematics Archive* [390] and to read the full articles as well as articles on other key personalities. But a good understanding of history is rarely obtained by reading from just one source.

In the context of history, all I will say here is that much of the topology described in this book was discovered in the first half of the twentieth century. And one could well say that the centre of gravity for this period of discovery was, Poland. (Borders have moved considerably.) It would be fair to say that World War II permanently changed the centre of gravity.

0.1 Acknowledgments

The author must first acknowledge Dr Ian D. Macdonald who, at the University of Queensland, first introduced him in 1967 to the subject of Topology and who also supervised in 1967/1968 his first research project on varieties of topological groups and free topological groups, which later became the topic of the research for his PhD thesis at Flinders University. The author’s PhD was supervised by Professor Igor Kluvanek, who introduced him to free compact abelian groups and to socialism, and who influenced the author’s approach to teaching mathematics as



Kluvanek



Hanna Neumann



did the author's lecturers: Dr Sheila Oates Williams, Professor Anne Penfold Street, Professor Rudolf Vyborny, Professor Des Nicholls, Professor Clive Davis and Dr John Belward at the University of Queensland. The author's love of mathematics was enhanced in 1963-1964 by Professor Graham Jones at Cavendish Road State High School, and later enriched by Professor Hanna Neumann and Professor Bernhard H. Neumann of the Australian National University.

The author's understanding of category theory and its significance was developed through discussions with Professor Gregory Maxwell Kelly of the University of New South Wales and Professor Saunders MacLane of the University of Chicago, USA.

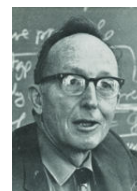

MacLane

The author's knowledge of Banach Space Theory and Topological Vector Space Theory was enhanced by discussions at the University of Florida in 1970 and 1971 with Joe Diestel and Steve Saxon.

The author has learnt a vast amount of mathematics from, and has had interesting and very useful conversations on the teaching of mathematics with, his coauthor Professor Karl Heinrich Hofmann of the Technical University of Darmstadt in Germany and Tulane University in New Orleans, USA.

The author's love of Topology began with two books on Topology, namely Kelley [233] and Dugundji [113].

Portions of earlier versions of this book were used at the University of New South Wales, the University College of North Wales, La Trobe University, University of New England, University of Wollongong, University of Queensland, University of South Australia, City College of New York, and the University of Ballarat over a period of about 40 years and online for about 2 decades. I wish to thank those students who criticized the earlier versions and identified errors.

Special thanks go to Deborah King and Allison Plant for pointing out numerous typos, errors and weaknesses in the presentation. Thanks also go to several others, some of them colleagues, including M. H. Alsuwaiyel, Marshall Ash, Jessica Banks, Ewan Barker, Colin Benner, Henno Brandsma, Dov Bulka, Leonardo De Angelis, James Dick, Will Dickinson, Bu Feiming, Alexey Guzey, Maria Gkerats, Eldar Hajilarov,



Plant

Karl Heinrich Hofmann, Manisha Jain, Ralph Kopperman, Ray-Shang Lo, Sordi Massimiliano, Aidan Murphy, Yash Nair, Rodney Nilsen, Guillermo Pineda-Villavicencio, Peter Pleasants, Kyriakos Papadopoulos, Strashimir Popvassilev, Geoffrey Prince, Carolyn McPhail Sandison, David Simpson, Bevan Thompson, Andrey Torba, Michiel Vermeulen, Roger Vogeler, Michael Zdunek, and Juqiang Zheng who read various versions and suggested improvements.

Particular thanks go to Rodney Nilsen whose notes on chaos theory were very useful in preparing the relevant appendix and to Jack Gray whose excellent University of New South Wales Lecture Notes "Set Theory and Transfinite Arithmetic", written in the 1970s, influenced the Appendix on Infinite Set Theory.



Nilsen

In various places in this book, especially Appendix 2, there are historical notes. I acknowledge two wonderful sources Bourbaki [51] and *The MacTutor History of Mathematics Archive* [390].

Initially the book was typeset using Donald Knuth's beautiful and powerful T_EX package. As the book was expanded and colour introduced, this was translated into L^AT_EX. For the last 30 years most mathematics books and journals have been typeset in some variety of T_EX or L^AT_EX.



Knuth

Appendix 5 is based on my 1977 book² "Pontryagin duality and the structure of locally compact abelian groups", Morris [293]. The 1977 book was based on a course I first gave in 1974 at the University College of North Wales in Bangor, Wales, UK at the request of Professor Ronald (Ronnie) Brown and subsequently delivered at the University of New South Wales in 1975 and La Trobe University, Melbourne, Australia in 1976. I am very grateful to Dr Carolyn McPhail Sandison of the University of Wollongong, who as a present to me, typeset this book in T_EX for me, more than 15 years ago.



Sandison

Some photographs of mathematicians are included in this book. Often these are from Wikipedia, <https://en.wikipedia.org>, and we gratefully acknowledge that wonderful source of information. Appropriate copyright information can be found at the end of each chapter.

0.2 Readers – Locations and Professions

This book has been, or is being, used by professors, graduate students, undergraduate students, high school students, and retirees, some of whom are studying to be, are or were, accountants, actuaries, applied and pure mathematicians, astronomers,

²Copyright was returned to the author by Cambridge University Press.

biologists, chemists, computer graphics, computer scientists, econometricians, economists, aeronautical, database, electrical, mechanical, software, space, spatial and telecommunications engineers, finance experts, game theorists, neurophysiologists, nutritionists, options traders, philosophers, physicists, psychiatrists, psychoanalysts, psychologists, sculptors, software developers, spatial information scientists, and statisticians in Algeria, Argentina, Australia, Austria, Bangladesh, Bolivia, Belarus, Belgium, Belize, Brazil, Bulgaria, Cambodia, Cameroon, Canada, Chile, Gabon, People's Republic of China, Colombia, Costa Rica, Croatia, Cyprus, Czech Republic, Denmark, Ecuador, Egypt, Estonia, Ethiopia, Fiji, Finland, France, Gaza, Germany, Ghana, Greece, Greenland, Guatemala, Guyana, Honduras, Hungary, Iceland, India, Indonesia, Iran, Iraq, Israel, Italy, Jamaica, Japan, Jordan, Kenya, Korea, Kuwait, Latvia, Liberia, Lithuania, Luxembourg, Malaysia, Malta, Mauritius, Mexico, New Zealand, Nicaragua, Nigeria, Norway, Pakistan, Panama, Paraguay, Peru, Poland, Portugal, Puerto Rico, Qatar, Romania, Russia, Senegal, Serbia, Sierra Leone, Singapore, Slovenia, South Africa, Spain, Sri Lanka, Sudan, Suriname, Sweden, Switzerland, Syria, Taiwan, Tanzania, Thailand, The Netherlands, Trinidad and Tobago, Tunisia, Turkey, United Kingdom, Ukraine, United Arab Emirates, United States of America, Uruguay, Uzbekistan, Venezuela, and Vietnam.

The book is referenced, in particular, on <http://econphd.econwiki.com/notes.htm> a website designed to make known useful references for “graduate-level course notes in all core disciplines” suitable for Economics students and on Topology Atlas a resource on Topology <http://at.yorku.ca/topology/educ.htm>.

0.3 Readers' Compliments

Jeffrey C., USA: “Topology Without Tears has been, and continues to be, the most accessible rigorous text on topology legally available on the net. Beyond providing a foundation on general topology, it was the book that made proof click with me. In so far as LaTeX markup, SID MORRIS has laid the gold standard for a mathematics texts for online and device viewing. It displays beautifully in all my devices and platforms.

The recent additions in quotient spaces and hausdorff dimension are very much appreciated as well.

Thank you Professor Morris!”

Hector R., Mexico: "I love your book";

T. L., USA: "delightful work, beautifully written";

Cesar, USA "As Topology wasn't a prerequisite for my class on Quantum Mechanics" (since I'm a physics major), I cannot express how helpful this book has been in studying Hilbert Spaces, and thus QM in general. Fantastic text. I've recommended to all my physics classmates, thank you so much Dr. Morris!"

Jari, Finland: "I got my exam in Topology back, which was my last exam in my master's degree. 5/5 thanks to Topology Without Tears! I dare to say that I would have had big problems without this book. So thank you very much and keep up the good work!"

Ashraf, Assistant Professor, Pakistant: "May Allah bestow the author with happiness, prosperity and health."

E. F., Australia: "your notes are fantastic";

Andreas L., Germany: "I really enjoy your script very much!";

Yao J., China: "I'm a engineering student from Zhejiang Sci-Tech University, Hangzhou, Zhejiang Province, China. I have looked through your book titled 'Topology without tears' which attractes me much";

E. Yuan, Germany: "it is really a fantastic book for beginners in Topology";

D. Johnson, USA: "Loving the book";

S. Kumar, India: "very much impressed with the easy treatment of the subject, which can be easily followed by nonmathematicians";

Pawin S., Thailand: "I am preparing myself for a Ph.D. (in economics) study and find your book really helpful to the complex subject of topology";

Hannes R., Sweden: "think it's excellent";

Manisha J., India:"I am reading this book and I must say that it is so easy to read. I have read many other books too, but this book is so easy to grasp.The words you have used are the words that we use so commonly and the way everything goes in a flow. I like it Sir. I was having a tough time with topology, maybe this will help me.Thank you Sir for this";

G. Gray, USA: "wonderful text";

Dipak B., India: "beautiful note";

Jan van L., Netherlands: "I've been reading in your textbook for about one hour in the middle of the night - after hours (days) of searching for a book with a clear and extended explanation of topology basics. And I realised I found it - your textbook."

Daniel C., Hungary: "I am an economics student at the Eotvos Lorand University, Budapest and currently I am reading and studying your book 'Topology without

tears', which I find truly fascinating.";

Andrea J., Long Beach, USA: "'Topology Without Tears' is exactly what I have needed to wrap my mind about this subject. I appreciate your huminatarian effort for people like me!";

B. Pragoff Jr, USA: "explains topology to an undergrad very well";

Tapas Kumar B., India: "an excellent collection of information";

Debanshu R., India: "I have had the recent opportunity to find your book "Topology without Tears" from your web page. And I can't describe how much I appreciate it. I am currently a Mathematics undergrad (3rd yr) in India. And I had my first course of Topology last semester and your book has really been an exciting piece of reference for me. And my sister is also into Mathematics and I introduced her to your book. And she says that she loves it";.

Bosko D., Serbia: " I read on computer Your book Topology without tears. It is very nice book";

Kyriakos Papadopoulos, Xanthi, Greece: "I discovered your book online, and I loved the way you explain complicated ideas!";

Mekonnen Y., Ethiopia "I have found it extremely important reference for my postgraduate study. it seems that it would be very difficult to me to master the subject matter in topology without it i will also remind you in my life long as a big contribution";

Yassine A.: " A great book to understand something like topology that dont make difference between daughnuts and cup of coffee";

Muhammad Sani A., Nigeria: "I don't even know the words to use,in order to express my profound gratitude, because, to me a mere saying 'thank you very much' is not enough. However, since it a tradition, that whenever a good thing is done to you, you should at least, say 'thank you' I will not hesitate to say the same, but, I know that, I owe you more than that, therefore, I will continue praying for you";

Spyridon N. D., Greece: "I recently found out about your book "Topology without Tears". I would like to teach myself some topology. Having read a few pages of your book "Topology without Tears" carefully , I think it will be of tremendous help to this cause;"

Emelife O., Nigeria: "i am an M.sc student in the department of mathematics at Nnamdi Azikiwe University Awka Nigeria, read about your book "topology without tears" on net, i am indebted to people like you who chose not to hid knowledge because of money";

S. Saripalli, USA: "I'm a homeschooled 10th grader . . . I've enjoyed reading Topology

Without Tears”;

Roman G., Czech Republic: “I would like to ask you to send me a password for a printable copy of your wonderful book "Topology without Tears". I am a graduate student in Economics at CERGE-EI, in Prague.”;

Samuel F., USA: “Firstly I would like to thank you for writing an excellent Topology text, I have finished the first two chapters and I really enjoy it. I would suggest adding some "challenge" exercises. The exercises are a little easy. Then again, I am a mathematics major and I have taken courses in analysis and abstract algebra and your book is targeted at a wider audience. You see, my school is undergoing a savage budget crisis and the mathematics department does not have enough funds to offer topology so I am learning it on my own because I feel it will give me a deeper understanding of real and complex analysis”;

Maria Amarakristi O., Nigeria: “ I am a final year student of Mathematics in University of Nigeria.... I found your book profoundly interesting as it makes the challenging course - topology more interesting. The presentation is very good and for a beginner like me, it will be of very great help in understanding the fundamentals of General topology.”;

Andree G., Peru: "I would like you to let me download your spanish version of the book, it is only for private use, Im coursing economics and Im interested in learning about the topic for my self. I study in San Marcos University that its the oldest university of Latin America";

Eszter C., Hungary: “I am an undergraduate student studying Math-ematical Economics ... I’m sure that you have heard it many times before, but I will repeat it anyway that the book is absolutely brilliant!”;

Prof. Dr. Mehmet T., Yasar Universit, Turkey: “I would like to use your book “Topology without tears” in my class. Would you like to send me a (free) printable version of your WONDERFUL work”;

Christopher R., Australia: “May I first thank you for writing your book ‘Topology without tears’? Although it is probably very basic to you, I have found reading it a completely wonderful experience”;

Jeanine D., USA: “I am currently taking Topology and I am having an unusual amount of difficulty with the class. I have been reading your book online as it helps so much”;

Dr. Anwar F., Qassim University, Saudi Arabia: “I would like to congratulate you for your nice book " TOPOLOGY WITHOUT TEARS" . It is really a wonderful book. It is very nice as a text book because it is written in a way that is very easy

to the student to understand. I am teaching Topology for undergraduate students. I found your book very good and easy for the student to understand. I would like to use your book " TOPOLOGY WITHOUT TEARS" as a text book for my students. Could you please tell me how to order some copies of the book in Arabic language for the students and also for the library?"

Michael N., Macau: "Unlike many other math books, your one is written in a friendly manner. For instance, in the early chapters, you gave hints and analysis to almost all the proof of the theorems. It makes us, especial the beginners, easier to understand how to think out the proofs. Besides, after each definition, you always give a number of examples as well as counterexamples so that we can have a correct and clear idea of the concept";

Elise D., UK: " I am currently studying Topology at Oxford University. I am finding the book I am currently using is more difficult than expected. My tutor recommended your book "Topology Without Tears";"

Tarek Fouda, USA: "I study advanced calculus in Stevens institute of technology to earn masters of science in financial engineering major. It is the first time I am exposed to the subject of topology. I bought few books but I find yours the only that explains the subject in such an interesting way and I wish to have the book with me just to read it in train or school."

Ahmad A., Malaysia: "I am Ph.D. student in UKM (Malaysia) my area of research is general topology and I find your book is very interesting";

Jose V., Uruguay: "In this semester I am teaching Topology in the Facultad de Ciencias of Universidad de la Republica. I would like to have a printable version of your (very good) book."

Muhammad Y. B., Professor of Mathematics, Bayero University, Nigeria: "Your ebook, 'Topology Without Tears', is an excellent resource for anyone requiring the knowledge of topology. I do teach some analysis courses which assumes basic background in topology. Unfortunately, some of my students either do not have such a background, or have forgotten it. After going through the electronic version, I observe your book would be a good source of refreshing/providing the background to the students."

Prof. dr. Ljubomir R. S., Institute for Mechanics and Theory of Structures, University of Belgrade, Serbia: "I just learn topology and I have seen your superb book. My field is in fact Continuum Mechanics and Structural Analysis";

Pascal L., Germany: "I must print your fantastic book for writing notes on edge of the real sheets of paper";

Professor Luis J. A., Department of Mathematics at University of Murcia, Spain: "I have just discovered your excellent text "Topology Without Tears". During this course, I will be teaching a course on General Topology (actually, I will start my course tomorrow morning). I started to teach that course last year, and essentially I followed Munkres's book (Topology, Second edition), from which I covered Chapters 2, 3, part of 4, 5, and part of 9. I have been reading your book and I have really enjoyed it. I like it very much, specially the way you introduce new concepts and also the hints and key remarks that you give to the students."

Daniel N., Lecturer, Department of Physics, University of Buea, Cameroon: "After many years of struggle to understand the rudiments of topology, without any success at all, I gave up!. Then recently I stumbled upon your God-sent text while browsing the web. Flipping through the pages of the on-line I am convinced that if I cannot understand the subject from this text, then no other book can probably help me";

Tirthankar C., Oxford University, UK: "I am the University of Cambridge and am an econometrician. Your notes are very well written";

Thomas E., Germany: "I was intensely attracted to contents and style. Especially, I like the way you introduce the basics and make them work via exercises and guided proofs.";

Gabriele. E.M. B. MD PhD, Head of Research, Institute of Molecular Bioimaging and Physiology, National Research Council, Italy: "I am a neurophysiologist and am trying to achieve some new neurodynamic description of sensory processes by topological approach. I stepped into your wonderful book."

Fazal H., Pakistan: "I am PhD student in the faculty of Engineering Ghulam Ishaq Khan Institute of Sciences and Technology Topi swabi Pakistan. I was surprised by reading your nice book topology without tears. In fact i have never seen such a beautifully weitten book on topology before";

Gabriele L., Italy: "I'm just a young student, but I found very interesting the way you propose the topology subject, especially the presence of so many examples";

K. Orr, USA: "excellent book";

Professor Ahmed Ould, Colombia: "let me congratulate you for presentation, simplicity and the clearness of the material";

Paul U., USA: "I like your notes since they provide many concrete examples and do not assume that the reader is a math major";

Alberto Garcia Raboso, Spain: "I like it very much";

Guissepe Curci, Research Director in Theoretical Physics, National Institute of Theoretical Physics, Pisa: "nice and illuminating book on topology";

M. Rinaldi, USA: "this is by far the clearest and best introduction to topology I have ever seen . . . when I studied your notes the concepts clicked and your examples are great";

Joaquin P., Undergraduate Professor of Economics, Catholic University of Chile: "I have just finished reading your book and I really liked it. It is very clear and the examples you give are revealing";

Alexander L., Sweden: "I've been enjoying reading your book from the screen but would like to have a printable copy"

Francois N., USA: "I am a graduate student in a spatial engineering course at the University of Maine (US), and our professor has enthusiastically recommended your text for the Topology unit.";

Hsin-Han S., USA: "I am a Finance PhD student in State Univ of New York at Buffalo. I found the Topology materials on your website is very detailed and readable, which is an ideal first-course-in topology material for a PhD student who does not major in math, like me";

Degin C., USA: "your book is wonderful";

Eric Y., Darmstadt, Germany: "I am now a mathematics student in Darmstadt University of Technology, studying Topology, and our professor K.H. Hofmann recommended your book 'Topology Without Tears' very highly";

Martin V., Oxford University: "I am an Msc student in Applied Math here in oxford. Since I am currently getting used to abstract concepts in maths, the title of the book topology without tears has a natural attraction";

Ahmet E., Turkey: "I liked it a lot";

Kartika B., India: "i am pursuing my master in economics here at Delhi School of Economics, University of Delhi,I found your book very useful and easy to understand. Many of my doubts have been solved while reading your book";

Wolfgang M., Belgium:"I am a Bachelor-student of the "Katholieke Universiteit Leuven. I found myself reading most of the first part of "Topology Without Tears" in a matter of hours. Before I proceed, I must praise you for your clear writing and excellent structure (it certainly did not go unnoticed!)"

Duncan C., USA: "You must have received emails like this one many times, but I would still like thanks you for the book 'Topology without Tears'. I am a professional software developer and enjoy reading mathematics."

Maghaisvarei S., Singapore: "I will be going to US to do my PhD in Economics shortly. I found your book on topology to be extremely good";

Tom H., USA: "thank you for making your fine text available on the web";

Fausto S., Italy: "i'm reading your very nice book and this is the best one I saw until now about this subject";

Takayuki O., USA: " started reading your "Topology Without Tears" online, and found that it is a very nice material to learn topology as well as general mathematical concept";

Roman K., Germany: "Thank you very much for letting me read your great book. The 'topology without tears' helped me a lot and i regained somehow my interest in mathematics, which was temporarily lost because of unsystematic lectures and superfluous learning by heart";

Yuval Y., USA:"I had a look at the book and it does seem like a marvelous work";

N.S. M., Greece: "It is a very good work";

Semih T., Turkey: "I know that PhD in Economics programs are mathematically demanding, so I found your book extremely useful while reviewing the necessary topics";

Pyung Ho K., USA: "I am currently a Ph.D. student... I am learning economic geography, and i found your book is excellent to learn a basic concept of topology";

Javier H., Turkey: "I am really grateful to all those, which like you, spend their efforts to share knowledge with the others, without thinking only in the benefit they could get by hiding the candle under the table and getting money to let us spot the light";

Martin D. S., Center for Economics and Development Studies (CEDs), Padjadjaran University, Bandung, Indonesia: "I found it is very useful for me, since next September I will continue my study at Stockholm School of Economics. Thank you very much for what you have done, it helps me a lot, for my preparation before I go to the grad school."

J. Chand, Australia: "Many thanks for producing topology without tears. Your book is fantastic.";

Richard Vande V., USA: "Two years ago I contacted you about downloading a copy of your "Topology without Tears" for my own use. At that time I was teaching a combined undergraduate / graduate course in topology. I gave the students the URL to access (online) the text. Even though I did not follow the topics and development in exactly the same order which you do, one of the better students in the class indicated that I should have made that the one and only required text for the course! I think that is a nice recommendation. Well, history repeats itself and two years later I am again teaching the same course to the same sort of audience. So, I would like to be able to download a complete version of the text";

Professor Sha Xin W., Fine Arts and Computer Science, Concordia University, Canada:

"Compliments on your very carefully and humanely written text on topology! I would like to consider adopting it for a course introducing "living" mathematics to ambitious scholarly peers and artists. It's always a pleasure to find works such as yours that reaches out to peers without compromise.";

Associate Professor Dr Rehana B., Bangladesh: "I am a course teacher of Topology in M.Sc. class of the department of Mathematics, University of Dhaka, Bangladesh. Can I have a copy of your wonderful book "Topology Without Tears" for my personal use?";

Emrah A., Department of Mathematics, Anadolu University, Turkey: "I have just seen your beautiful book "Topology without Tears" and I m planning to follow your book for this summer semester";

Rahul N., PhD Student, Department of Economics University of Southern California, USA: "I am a PhD student at the Department of Economics of the University of Southern California, Los Angeles. I hope to work in the area of general equilibrium with incomplete markets. This area requires a thorough understanding of topological concepts. Your excellent book was referred to me by a colleague of mine from Kansas University (a Mr. Ramu Gopalan). After having read part of the book from the non-printable pdf file, I have concluded that this is the book that I want to read to learn topology."

Long N., USA "I have never seen any book so clear on such a difficult subject";

Renato O., Chile: "Congratulations for your great book. I went through the first chapters and had a great time. I thought that topology was out of my reach, now I declare myself an optimist in this matter. ";

Sisay Regasa S., Assistant Dean, Faculty of Business and Economics, Addis Ababa University Ethiopia: "I am prospective PhD student of Economics currently a lecturer in Economics at Economics Department of Addis Ababa University, Ethiopia, East Africa. Could you please send me the printable version of your book?"

Nicanor M. T., Davao Oriental State College of Science and Technology, Philippines: "Greetings! I would like to express my gratitude for your unselfish act of sharing your instructional resources, you indeed help me and my students gain topological maturity. Thanks and more power";

Ernita R. C., Philippines: "I'm Ms. Ernita R. Calayag, a Filipino, student of De La Salle University taking up Ph. D. in Mathematics. I heard good things about your book "Topology Without Tears" and as student of mathematics, I just can't miss the

opportunity of having a copy and enjoy its benefits. I hope that with your approval I can start to understand Topology more as a foundational subject of mathematics."

Nikola M., Serbia: "Your book is really unique and valuable, suitable for a wide audience. This is a precious gift from You, which is appreciated worldwide. I think that almost everybody who needs to obtain appropriate knowledge in topology can benefit greatly from Your book."

Iraj D., Iran: "(please excuse me for unsuitable letter) i am mechanical engineer. but i very very interest mathematics (more like to analysis). i am study myself without teacher. some subject in this is difficult for me (for example topology and abstract analysis) because my experiment in pure mathematics isn't high yet. i now study your book(topology whithout tears). this book very very different from other books in this subject and teached me many things which abstract for me until now.[thank you]";

Dr Abdul I., Bayero University, Kano, Nigeria: "My name is ABDUL IGUDA (PhD-in General Topology). I have been teaching General Topology for the past 18 years in my university, I am also a visiting lecturer to some orther two universities (Gwambe State University and Umaru Musa Yar'Adua University). Sir, I will like to posses a (free) printable Vesion of your Book (Topology Without Tears). Thank you very much";

Mahdi J., KNTToosi University, Tehran, Iran: "My name is Mahdi Jafari and study space engineering."

Jayakrishnan M, K., India:"I am an undergraduate student of mathematics and I have started learning topology this year. All that I learned so far was 'topology with tears'. Topology has been the most difficult area for me (until I found your book). However I was able to swallow some theorems. But I always stumbled upon problems. I think it is futile to go further, simply swallowing more theorems without clearly understanding the subject matter and without being able to solve even a problem. Having such great difficulty in taking topology, I searched the internet for some resource which would help me. Most of the stuff I found was more or less the same to the books and notes that I used to follow. But I was delighted to find TOPOLOGY WITHOUT TEARS, an excellent, totally different work in which the substance is beautifully presented; each definition is made clear with a number of good examples. Your work stands apart for its lucidity. Now I really enjoy learning topology. I express my sincere gratitude to you for making topology an interesting subject for me."

M.A.R. K., Karachi: "thank you for remembering a third world student".

0.4 Helpful Hint on Hyperlinks

If you are using the pdf file of this book on a computer or tablet rather than using a print copy, you should find the hyperlinks very useful. Often when you use a hyperlink to a previous theorem or definition in this book, you will want to return to the page you were studying. On many pdf readers, including Adobe, this can be achieved by simultaneously pressing the ALT key and the LEFT ARROW key.

0.5 The Author

The author is Sidney (Shmuel) Allen Morris, Emeritus Professor of Federation University Australia and Adjunct Professor of La Trobe University, Australia. Until 2010 he was Professor of Informatics and Head of the Graduate School of Information Technology and Mathematical Sciences of the University of Ballarat. He has been a tenured (full) Professor of Mathematics at the University of South Australia, the University of Wollongong, and the University of New England. He has also held positions at the University of New South Wales, La Trobe University, University of Adelaide, Tel Aviv University, Tulane University and the University College of North Wales in Bangor. He won the Lester R. Ford Award from the Mathematical Association of America and an Outstanding Service Award from the Australian Computer Society. He is currently joint Editor of the Gazette of the Australian Mathematical Society, on the Editorial Board of the Open access journal Axioms, has served as Editor-in-Chief of the Journal of Research and Practice in Information Technology, the Editor of the Bulletin of the Australian Mathematical Society, a founding Editor of the Journal of Group Theory, and the founding Editor-in-Chief of the Australian Mathematical Lecture Series – a series of books published by Cambridge University Press. He is also on the editorial boards of the Turkish open access journals Universal Journal of Mathematics and Applications and Fundamental Journal of Mathematics and Applications, and on the Advisory Board of the open access post-publication open peer-review journal Sci. He has authored or coauthored four books:

- (1) with Karl Heinrich Hofmann, “The Lie Theory of Connected Pro-Lie Groups: A Structure Theory for Pro-Lie Algebras, Pro-Lie Groups, and Connected Locally Compact Groups”, European Mathematical Society Publishing House, xv + 678pp, 2007, ISBN 978-3-03719-032-6;
- (2) with Karl Heinrich Hofmann “The Structure of Compact Groups: A Primer for the Student — A Handbook for the Expert”, Third Edition, xxii + 924pp., de

Gruyter 2013. ISBN 978-3-11-029655-6

- (3) “Pontryagin Duality and the Structure of Locally Compact Abelian Groups”, Cambridge University Press, 1977, 136pp. (Translated into Russian and published by Mir);
- (4) with Arthur Jones and Kenneth R. Pearson, “Abstract Algebra and Famous Impossibilities”, Springer-Verlag Publishers, 1st ed. 1991, ISBN 0-387-97661-2, Corr. 2nd printing 1993, ISBN 3-540-97661-2

and about 160 research papers in refereed international journals.

He edited a Special Issue of the refereed international open source journal *Axioms*, <http://www.mdpi.com/journal/axioms>. The Special Issue published also as a book, is called “Topological Groups: Yesterday, Today and Tomorrow”. In 2019 he edited the Open Access book: “Topological Groups: Advances, Surveys and Open Questions”, <http://www.mdpi.com/books/pdfview/book/1157>.

He is an Honorary Life Member of the Australian Mathematical Society, and served as its Vice-President, and has been a member of its Council for 25 years. He was born in Brisbane in 1947, went to Cavendish Road State High School, graduated with a BSc(Hons) from the University of Queensland and a year later received a PhD from Flinders University. He has held the senior administrative, management and leadership positions of Head of Department, Head of School, Deputy Chair of Academic Board, Deputy Chair of Academic Senate, Vice-Dean, Dean, Deputy Vice-Chancellor and Vice-President, Chief Academic Officer (CAO) and Chief Executive Officer(CEO). He has also served as Acting Vice-Chancellor and Acting President.

In 2016 he gave a Plenary Address at IECMSA-2016, the 5th International Eurasian Conference on Mathematical Sciences and Applications, Belgrade-Serbia.

In 2016 he was also ordained as a Rabbi and became a grandfather. In 2017 his second grandchild was born. He also edited a Special Collection called *Topological Groups* in the journal *Axioms*. In 2018 & 2019 he is coauthoring the fourth edition of the book “The Structure of Compact Groups”.

His home page is www.sidneymorris.net

0.6 Credits for Images

1. Hanna Neumann: By Konrad Jacobs, Erlangen - The Oberwolfach Photo Collection, CC BY-SA 2.0 de, <https://commons.wikimedia.org/w/index.php?curid=6739429>

2. B. H. Neumann: By Konrad Jacobs, Erlangen, Copyright is MFO - Mathematisches Forschungsinstitut Oberwolfach,
[http://owpdb.mfo.de/detail?photo\\$_\\$id=3003,CCBY-SA2.0de](http://owpdb.mfo.de/detail?photo$_$id=3003,CCBY-SA2.0de),
<https://commons.wikimedia.org/w/index.php?curid=12341341>
3. Saunders MacLane: By Konrad Jacobs
(<http://owpdb.mfo.de/detail?photoID=2684>) [CC BY-SA 2.0 de
(<http://creativecommons.org/licenses/by-sa/2.0/de/deed.en>)], Wikimedia Commons.
4. Alison Plant: Photo provided to the author on June 5, 2017 for inclusion here.
5. Rodney (Rod) V. Nilsen: Photo taken on June 6, 2017 by Rod Nilsen and provided to the author for inclusion here.
6. Donald Knuth: By Flickr user Jacob Appelbaum, uploaded to en.wikipedia by users BeSherman, Duozmo - Flickr.com (via en.wikipedia), CC BY-SA 2.5,
<https://commons.wikimedia.org/w/index.php?curid=1303242>
7. Carolyn (Caz) McPhail Sandison: Photo provided to the author on June 5, 2017 for inclusion here.

©Copyright 1985-2019. No part of this book may be reproduced by any process without prior written permission from the author.

Chapter 1

Topological Spaces

Introduction

Tennis, football, baseball and hockey may all be exciting games but to play them you must first learn (some of) the rules of the game. Mathematics is no different. So we begin with the rules for topology.

This chapter opens with the definition of a topology and is then devoted to some simple examples: finite topological spaces, discrete spaces, indiscrete spaces, and spaces with the finite-closed topology.

Topology, like other branches of pure mathematics such as group theory, is an axiomatic subject. We start with a set of axioms and we use these axioms to prove propositions and theorems. It is extremely important to develop your skill at writing proofs.

Why are proofs so important? Suppose our task were to construct a building. We would start with the foundations. In our case these are the axioms or definitions – everything else is built upon them. Each theorem or proposition represents a new level of knowledge and must be firmly anchored to the previous level. We attach the new level to the previous one using a proof. So the theorems and propositions are the new heights of knowledge we achieve, while the proofs are essential as they are the mortar which attaches them to the level below. Without proofs the structure would collapse.

So what is a mathematical proof?

A **mathematical proof** is a watertight argument which begins with information you are given, proceeds by logical argument, and ends with what you are asked to prove.

You should begin a proof by writing down the information you are given and then state what you are asked to prove. If the information you are given or what you are required to prove contains technical terms, then you should write down the definitions of those technical terms.

Every proof should consist of complete sentences. Each of these sentences should be a consequence of (i) what has been stated previously or (ii) a theorem, proposition or lemma that has already been proved.

In this book you will see many proofs, but note that mathematics is not a spectator sport. It is a game for participants. The only way to learn to write proofs is to try to write them yourself.

1.1 Topology

1.1.1 Definitions. Let X be a non-empty set. A set \mathcal{T} of subsets of X is said to be a **topology** on X if

- (i) X and the empty set, \emptyset , belong to \mathcal{T} ,
- (ii) the union of any (finite or infinite) number of sets in \mathcal{T} belongs to \mathcal{T} , and
- (iii) the intersection of any two sets in \mathcal{T} belongs to \mathcal{T} .

The pair (X, \mathcal{T}) is called a **topological space**.

1.1.2 Example. Let $X = \{a, b, c, d, e, f\}$ and

$$\mathcal{T}_1 = \{X, \emptyset, \{a\}, \{c, d\}, \{a, c, d\}, \{b, c, d, e, f\}\}.$$

Then \mathcal{T}_1 is a topology on X as it satisfies conditions (i), (ii) and (iii) of [Definitions 1.1.1](#). □

1.1.3 Example. Let $X = \{a, b, c, d, e\}$ and

$$\mathcal{T}_2 = \{X, \emptyset, \{a\}, \{c, d\}, \{a, c, e\}, \{b, c, d\}\}.$$

Then \mathcal{T}_2 is not a topology on X as the union

$$\{c, d\} \cup \{a, c, e\} = \{a, c, d, e\}$$

of two members of \mathcal{T}_2 does not belong to \mathcal{T}_2 ; that is, \mathcal{T}_2 does not satisfy condition (ii) of [Definitions 1.1.1](#). □

1.1.4 Example. Let $X = \{a, b, c, d, e, f\}$ and

$$\mathcal{T}_3 = \{X, \emptyset, \{a\}, \{f\}, \{a, f\}, \{a, c, f\}, \{b, c, d, e, f\}\}.$$

Then \mathcal{T}_3 is not a topology on X since the intersection

$$\{a, c, f\} \cap \{b, c, d, e, f\} = \{c, f\}$$

of two sets in \mathcal{T}_3 does not belong to \mathcal{T}_3 ; that is, \mathcal{T}_3 does not have property (iii) of [Definitions 1.1.1](#). □

1.1.5 Example. Let \mathbb{N} be the set of all natural numbers (that is, the set of all positive integers) and let \mathcal{T}_4 consist of \mathbb{N} , \emptyset , and all finite subsets of \mathbb{N} . Then \mathcal{T}_4 is not a topology on \mathbb{N} , since the infinite union

$$\{2\} \cup \{3\} \cup \dots \cup \{n\} \cup \dots = \{2, 3, \dots, n, \dots\}$$

of members of \mathcal{T}_4 does not belong to \mathcal{T}_4 ; that is, \mathcal{T}_4 does not have property (ii) of [Definitions 1.1.1](#). □

1.1.6 Definitions. Let X be any non-empty set and let \mathcal{T} be the collection of all subsets of X . Then \mathcal{T} is called the **discrete topology** on the set X . The topological space (X, \mathcal{T}) is called a **discrete space**.

We note that \mathcal{T} in [Definitions 1.1.6](#) does satisfy the conditions of [Definitions 1.1.1](#) and so is indeed a topology.

Observe that the set X in [Definitions 1.1.6](#) can be any non-empty set. So there is an infinite number of discrete spaces – one for each set X .

1.1.7 Definitions. Let X be any non-empty set and $\mathcal{T} = \{X, \emptyset\}$. Then \mathcal{T} is called the **indiscrete topology** and (X, \mathcal{T}) is said to be an **indiscrete space**.

Once again we have to check that \mathcal{T} satisfies the conditions of 1.1.1 and so is indeed a topology.

We observe again that the set X in Definitions 1.1.7 can be any non-empty set. So there is an infinite number of indiscrete spaces – one for each set X .

In the introduction to this chapter we discussed the importance of proofs and what is involved in writing them. Our first experience with proofs is in Example 1.1.8 and Proposition 1.1.9. You should study these proofs carefully.

You may like to watch the first of the YouTube videos on proofs. It is called

“Topology Without Tears – Video 4 – Writing Proofs in Mathematics”

and can be found on YouTube at

<http://youtu.be/T1snRQEQuEk>

or on the Chinese Youku site at

<http://tinyurl.com/mwpmlqs>

or by following the relevant link from

<http://www.topologywithouttears.net>.

1.1.8 Example. If $X = \{a, b, c\}$ and \mathcal{T} is a topology on X with $\{a\} \in \mathcal{T}$, $\{b\} \in \mathcal{T}$, and $\{c\} \in \mathcal{T}$, prove that \mathcal{T} is the discrete topology.

Proof.

We are given that \mathcal{T} is a topology and that $\{a\} \in \mathcal{T}$, $\{b\} \in \mathcal{T}$, and $\{c\} \in \mathcal{T}$.

We are required to prove that \mathcal{T} is the discrete topology; that is, we are required to prove (by [Definitions 1.1.6](#)) that \mathcal{T} contains all subsets of X . Remember that \mathcal{T} is a topology and so satisfies conditions (i), (ii) and (iii) of [Definitions 1.1.1](#).

So we shall begin our proof by writing down all of the subsets of X .

The set X has 3 elements and so it has 2^3 distinct subsets. They are: $S_1 = \emptyset$, $S_2 = \{a\}$, $S_3 = \{b\}$, $S_4 = \{c\}$, $S_5 = \{a, b\}$, $S_6 = \{a, c\}$, $S_7 = \{b, c\}$, and $S_8 = \{a, b, c\} = X$.

We are required to prove that each of these subsets is in \mathcal{T} . As \mathcal{T} is a topology, [Definitions 1.1.1](#) (i) implies that X and \emptyset are in \mathcal{T} ; that is, $S_1 \in \mathcal{T}$ and $S_8 \in \mathcal{T}$.

We are given that $\{a\} \in \mathcal{T}$, $\{b\} \in \mathcal{T}$ and $\{c\} \in \mathcal{T}$; that is, $S_2 \in \mathcal{T}$, $S_3 \in \mathcal{T}$ and $S_4 \in \mathcal{T}$.

To complete the proof we need to show that $S_5 \in \mathcal{T}$, $S_6 \in \mathcal{T}$, and $S_7 \in \mathcal{T}$. But $S_5 = \{a, b\} = \{a\} \cup \{b\}$. As we are given that $\{a\}$ and $\{b\}$ are in \mathcal{T} , [Definitions 1.1.1](#) (ii) implies that their union is also in \mathcal{T} ; that is, $S_5 = \{a, b\} \in \mathcal{T}$.

Similarly $S_6 = \{a, c\} = \{a\} \cup \{c\} \in \mathcal{T}$ and $S_7 = \{b, c\} = \{b\} \cup \{c\} \in \mathcal{T}$. \square

In the introductory comments on this chapter we observed that mathematics is not a spectator sport. You should be an active participant. Of course your participation includes doing some of the exercises. But more than this is expected of you. You have to think about the material presented to you.

One of your tasks is to look at the results that we prove and to ask pertinent questions. For example, we have just shown that if each of the singleton sets $\{a\}$, $\{b\}$ and $\{c\}$ is in \mathcal{T} and $X = \{a, b, c\}$, then \mathcal{T} is the discrete topology. You should ask if this is but one example of a more general phenomenon; that is, if (X, \mathcal{T}) is any topological space such that \mathcal{T} contains every singleton set, is \mathcal{T} necessarily the discrete topology? The answer is “yes”, and this is proved in [Proposition 1.1.9](#).

1.1.9 Proposition. If (X, \mathcal{T}) is a topological space such that, for every $x \in X$, the singleton set $\{x\}$ is in \mathcal{T} , then \mathcal{T} is the discrete topology.

Proof.

This result is a generalization of [Example 1.1.8](#). Thus you might expect that the proof would be similar. However, we cannot list all of the subsets of X as we did in [Example 1.1.8](#) because X may be an infinite set. Nevertheless we must prove that **every** subset of X is in \mathcal{T} .

At this point you may be tempted to prove the result for some special cases, for example taking X to consist of 4, 5 or even 100 elements. But this approach is doomed to failure. Recall our opening comments in this chapter where we described a mathematical proof as a watertight argument. We cannot produce a watertight argument by considering a few special cases, or even a very large number of special cases. The watertight argument must cover **all** cases. So we must consider the general case of an arbitrary non-empty set X . Somehow we must prove that every subset of X is in \mathcal{T} .

Looking again at the proof of [Example 1.1.8](#) we see that the key is that every subset of X is a union of singleton subsets of X and we already know that all of the singleton subsets are in \mathcal{T} . This is also true in the general case.

We begin the proof by recording the fact that every set is the union of all its singleton subsets; that is, if S be any subset of X , then

$$S = \bigcup_{x \in S} \{x\}.$$

Since we are given that each $\{x\}$ is in \mathcal{T} , [Definitions 1.1.1](#) (ii) and the above equation imply that $S \in \mathcal{T}$. As S is an arbitrary subset of X , we have that \mathcal{T} is the discrete topology. □

That every set S is a union of its singleton subsets is a result which we shall use from time to time throughout the book in many different contexts. Note that it holds even when $S = \emptyset$ as then we form what is called an **empty union** and get \emptyset as the result.

Exercises 1.1

1. Let $X = \{a, b, c, d, e, f\}$. Determine whether or not each of the following collections of subsets of X is a topology on X :
 - (a) $\mathcal{T}_1 = \{X, \emptyset, \{a\}, \{a, f\}, \{b, f\}, \{a, b, f\}\}$;
 - (b) $\mathcal{T}_2 = \{X, \emptyset, \{a, b, f\}, \{a, b, d\}, \{a, b, d, f\}\}$;
 - (c) $\mathcal{T}_3 = \{X, \emptyset, \{f\}, \{e, f\}, \{a, f\}\}$.

2. Let $X = \{a, b, c, d, e, f\}$. Which of the following collections of subsets of X is a topology on X ? (Justify your answers.)
 - (a) $\mathcal{T}_1 = \{X, \emptyset, \{c\}, \{b, d, e\}, \{b, c, d, e\}, \{b\}\}$;
 - (b) $\mathcal{T}_2 = \{X, \emptyset, \{a\}, \{b, d, e\}, \{a, b, d\}, \{a, b, d, e\}\}$;
 - (c) $\mathcal{T}_3 = \{X, \emptyset, \{b\}, \{a, b, c\}, \{d, e, f\}, \{b, d, e, f\}\}$.

3. If $X = \{a, b, c, d, e, f\}$ and \mathcal{T} is the discrete topology on X , which of the following statements are true?

(a) $X \in \mathcal{T}$;	(b) $\{X\} \in \mathcal{T}$;	(c) $\{\emptyset\} \in \mathcal{T}$;	(d) $\emptyset \in \mathcal{T}$;
(e) $\emptyset \in X$;	(f) $\{\emptyset\} \in X$;	(g) $\{a\} \in \mathcal{T}$;	(h) $a \in \mathcal{T}$;
(i) $\emptyset \subseteq X$;	(j) $\{a\} \in X$;	(k) $\{\emptyset\} \subseteq X$;	(l) $a \in X$;
(m) $X \subseteq \mathcal{T}$;	(n) $\{a\} \subseteq \mathcal{T}$;	(o) $\{X\} \subseteq \mathcal{T}$;	(p) $a \subseteq \mathcal{T}$.

[Hint. Precisely six of the above are true.]

4. Let (X, \mathcal{T}) be any topological space. Verify that **the intersection of any finite number of members of \mathcal{T} is a member of \mathcal{T}** .
 [Hint. To prove this result use “mathematical induction”.]

5. Let \mathbb{R} be the set of all real numbers. Prove that each of the following collections of subsets of \mathbb{R} is a topology.
- (i) \mathcal{T}_1 consists of \mathbb{R} , \emptyset , and every interval $(-n, n)$, for n any positive integer, where $(-n, n)$ denotes the set $\{x \in \mathbb{R} : -n < x < n\}$;
 - (ii) \mathcal{T}_2 consists of \mathbb{R} , \emptyset , and every interval $[-n, n]$, for n any positive integer, where $[-n, n]$ denotes the set $\{x \in \mathbb{R} : -n \leq x \leq n\}$;
 - (iii) \mathcal{T}_3 consists of \mathbb{R} , \emptyset , and every interval $[n, \infty)$, for n any positive integer, where $[n, \infty)$ denotes the set $\{x \in \mathbb{R} : n \leq x\}$.
6. Let \mathbb{N} be the set of all positive integers. Prove that each of the following collections of subsets of \mathbb{N} is a topology.
- (i) \mathcal{T}_1 consists of \mathbb{N} , \emptyset , and every set $\{1, 2, \dots, n\}$, for n any positive integer. (This is called the **initial segment topology**.)
 - (ii) \mathcal{T}_2 consists of \mathbb{N} , \emptyset , and every set $\{n, n+1, \dots\}$, for n any positive integer. (This is called the **final segment topology**.)
7. List all possible topologies on the following sets:
- (a) $X = \{a, b\}$;
 - (b) $Y = \{a, b, c\}$.
8. Let X be an infinite set and \mathcal{T} a topology on X . If every infinite subset of X is in \mathcal{T} , prove that \mathcal{T} is the discrete topology.

9.* Let \mathbb{R} be the set of all real numbers. Precisely three of the following ten collections of subsets of \mathbb{R} are topologies. Identify these and justify your answer.

- (i) \mathcal{T}_1 consists of \mathbb{R} , \emptyset , and every interval (a, b) , for a and b any real numbers with $a < b$;
- (ii) \mathcal{T}_2 consists of \mathbb{R} , \emptyset , and every interval $(-r, r)$, for r any positive real number;
- (iii) \mathcal{T}_3 consists of \mathbb{R} , \emptyset , and every interval $(-r, r)$, for r any positive rational number;
- (iv) \mathcal{T}_4 consists of \mathbb{R} , \emptyset , and every interval $[-r, r]$, for r any positive rational number;
- (v) \mathcal{T}_5 consists of \mathbb{R} , \emptyset , and every interval $(-r, r)$, for r any positive irrational number;
- (vi) \mathcal{T}_6 consists of \mathbb{R} , \emptyset , and every interval $[-r, r]$, for r any positive irrational number;
- (vii) \mathcal{T}_7 consists of \mathbb{R} , \emptyset , and every interval $[-r, r)$, for r any positive real number;
- (viii) \mathcal{T}_8 consists of \mathbb{R} , \emptyset , and every interval $(-r, r]$, for r any positive real number;
- (ix) \mathcal{T}_9 consists of \mathbb{R} , \emptyset , every interval $[-r, r]$, and every interval $(-r, r)$, for r any positive real number;
- (x) \mathcal{T}_{10} consists of \mathbb{R} , \emptyset , every interval $[-n, n]$, and every interval $(-r, r)$, for n any positive integer and r any positive real number.

1.2 Open Sets, Closed Sets, and Clopen Sets

Rather than continually refer to “members of \mathcal{T} ”, we find it more convenient to give such sets a name. We call them “open sets”. We shall also name the complements of open sets. They will be called “closed sets”. This nomenclature is not ideal, but derives from the so-called “open intervals” and “closed intervals” on the real number line. We shall have more to say about this in [Chapter 2](#).

1.2.1 Definition. Let (X, \mathcal{T}) be any topological space. Then the members of \mathcal{T} are said to be **open sets**.

1.2.2 Proposition. If (X, \mathcal{T}) is any topological space, then

- (i) X and \emptyset are open sets,
- (ii) the union of any (finite or infinite) number of open sets is an open set, and
- (iii) the intersection of any finite number of open sets is an open set.

Proof. Clearly (i) and (ii) are trivial consequences of [Definition 1.2.1](#) and [Definitions 1.1.1](#) (i) and (ii). The condition (iii) follows from [Definition 1.2.1](#) and [Exercises 1.1 #4](#). □

On reading [Proposition 1.2.2](#), a question should have popped into your mind: while any finite or infinite union of open sets is open, we state only that finite intersections of open sets are open. Are infinite intersections of open sets always open? The next example shows that the answer is “no”.

1.2.3 Example. Let \mathbb{N} be the set of all positive integers and let \mathcal{T} consist of \emptyset and each subset S of \mathbb{N} such that the complement of S in \mathbb{N} , $\mathbb{N} \setminus S$, is a finite set. It is easily verified that \mathcal{T} satisfies [Definitions 1.1.1](#) and so is a topology on \mathbb{N} . (In the next section we shall discuss this topology further. It is called the finite-closed topology.) For each natural number n , define the set S_n as follows:

$$S_n = \{1\} \cup \{n+1\} \cup \{n+2\} \cup \{n+3\} \cup \cdots = \{1\} \cup \bigcup_{m=n+1}^{\infty} \{m\}.$$

Clearly each S_n is an open set in the topology \mathcal{T} , since its complement is a finite set. However,

$$\bigcap_{n=1}^{\infty} S_n = \{1\}. \quad (1)$$

As the complement of $\{1\}$ is neither \mathbb{N} nor a finite set, $\{1\}$ is not open. So (1) shows that the intersection of the open sets S_n is not open. \square

You might well ask: how did you find the example presented in [Example 1.2.3](#)? The answer is unglamorous! It was by trial and error.

If we tried, for example, a discrete topology, we would find that each intersection of open sets is indeed open. The same is true of the indiscrete topology. So what you need to do is some intelligent guesswork.

Remember that to prove that the intersection of open sets is not necessarily open, you need to find just one counterexample!

1.2.4 Definition. Let (X, \mathcal{T}) be a topological space. A subset S of X is said to be a **closed set** in (X, \mathcal{T}) if its complement in X , namely $X \setminus S$, is open in (X, \mathcal{T}) .

In [Example 1.1.2](#), the closed sets are

$$\emptyset, X, \{b, c, d, e, f\}, \{a, b, e, f\}, \{b, e, f\} \text{ and } \{a\}.$$

If (X, \mathcal{T}) is a discrete space, then it is obvious that every subset of X is a closed set. However in an indiscrete space, (X, \mathcal{T}) , the only closed sets are X and \emptyset .

1.2.5 Proposition. If (X, \mathcal{T}) is any topological space, then

- (i) \emptyset and X are closed sets,
- (ii) the intersection of any (finite or infinite) number of closed sets is a closed set and
- (iii) the union of any finite number of closed sets is a closed set.

Proof. (i) follows immediately from [Proposition 1.2.2 \(i\)](#) and [Definition 1.2.4](#), as the complement of X is \emptyset and the complement of \emptyset is X .

To prove that (iii) is true, let S_1, S_2, \dots, S_n be closed sets. We are required to prove that $S_1 \cup S_2 \cup \dots \cup S_n$ is a closed set. It suffices to show, by [Definition 1.2.4](#), that $X \setminus (S_1 \cup S_2 \cup \dots \cup S_n)$ is an open set.

As S_1, S_2, \dots, S_n are closed sets, their complements $X \setminus S_1, X \setminus S_2, \dots, X \setminus S_n$ are open sets. But

$$X \setminus (S_1 \cup S_2 \cup \dots \cup S_n) = (X \setminus S_1) \cap (X \setminus S_2) \cap \dots \cap (X \setminus S_n). \quad (1)$$

As the right hand side of (1) is a finite intersection of open sets, it is an open set. So the left hand side of (1) is an open set. Hence $S_1 \cup S_2 \cup \dots \cup S_n$ is a closed set, as required. So (iii) is true.

The proof of (ii) is similar to that of (iii). [However, you should read the warning in the proof of [Example 1.3.9](#).] □

Warning. The names “open” and “closed” often lead newcomers to the world of topology into error. Despite the names, some open sets are also closed sets! Moreover, some sets are neither open sets nor closed sets! Indeed, if we consider [Example 1.1.2](#) we see that

- (i) the set $\{a\}$ is both open and closed;
- (ii) the set $\{b, c\}$ is neither open nor closed;
- (iii) the set $\{c, d\}$ is open but not closed;
- (iv) the set $\{a, b, e, f\}$ is closed but not open.

In a discrete space every set is both open and closed, while in an indiscrete space (X, \mathcal{T}) , all subsets of X except X and \emptyset are neither open nor closed. \square

To remind you that sets can be both open and closed we introduce the following definition.

1.2.6 Definition. A subset S of a topological space (X, \mathcal{T}) is said to be **clopen** if it is both open and closed in (X, \mathcal{T}) .

In every topological space (X, \mathcal{T}) both X and \emptyset are clopen¹.

In a discrete space all subsets of X are clopen.

In an indiscrete space the only clopen subsets are X and \emptyset .

Exercises 1.2

1. List all 64 subsets of the set X in [Example 1.1.2](#). Write down, next to each set, whether it is (i) clopen; (ii) neither open nor closed; (iii) open but not closed; (iv) closed but not open.
2. Let (X, \mathcal{T}) be a topological space with the property that every subset is closed. Prove that it is a discrete space.

¹We admit that “clopen” is an ugly word but its use is now widespread.

3. Observe that if (X, \mathcal{T}) is a discrete space or an indiscrete space, then every open set is a clopen set. Find a topology \mathcal{T} on the set $X = \{a, b, c, d\}$ which is not discrete and is not indiscrete but has the property that every open set is clopen.
4. Let X be an infinite set. If \mathcal{T} is a topology on X such that every infinite subset of X is closed, prove that \mathcal{T} is the discrete topology.
5. Let X be an infinite set and \mathcal{T} a topology on X with the property that the only infinite subset of X which is open is X itself. Is (X, \mathcal{T}) necessarily an indiscrete space?
6. (i) Let \mathcal{T} be a topology on a set X such that \mathcal{T} consists of precisely four sets; that is, $\mathcal{T} = \{X, \emptyset, A, B\}$, where A and B are non-empty distinct proper subsets of X . [A is a **proper subset** of X means that $A \subseteq X$ and $A \neq X$. This is denoted by $A \subset X$.] Prove that A and B must satisfy exactly one of the following conditions:

$$(a) B = X \setminus A; \quad (b) A \subset B; \quad (c) B \subset A.$$

[Hint. Firstly show that A and B must satisfy at least one of the conditions and then show that they cannot satisfy more than one of the conditions.]

- (ii) Using (i) list all topologies on $X = \{1, 2, 3, 4\}$ which consist of exactly four sets.

Distinct Topologies on Finite and Infinite Sets

7. (i) As recorded in http://en.wikipedia.org/wiki/Finite_topological_space, the number of distinct topologies on a set with $n \in \mathbb{N}$ points can be very large even for small n ; namely when $n = 2$, there are 4 topologies; when $n = 3$, there are 29 topologies; when $n = 4$, there are 355 topologies; when $n = 5$, there are 6942 topologies etc. Using mathematical induction, prove that as n increases, the number of topologies increases.

[Hint. It suffices to show that if a set with n points has M distinct topologies, then a set with $n + 1$ points has at least $M + 1$ topologies.]

- (ii) Using mathematical induction prove that if the finite set X has $n \in \mathbb{N}$ points, then it has at least $(n - 1)!$ distinct topologies.

[Hint. Let $X = \{x_1, \dots, x_n\}$ and $Y = \{x_1, \dots, x_n, x_{n+1}\}$. if \mathcal{T} is any topology on X , fix an $i \in \{1, 2, \dots, n\}$. Define a topology \mathcal{T}_i on Y as follows: For each open set $U \in \mathcal{T}$, define U_i by replacing any occurrence of x_i in U by x_{n+1} ; then \mathcal{T}_i consists of all such U_i plus the set Y . Verify that \mathcal{T}_i is indeed a topology on Y . Deduce that for each topology on X , there are at least n distinct topologies on Y .]

- (iii) If X is any infinite set of cardinality \aleph , prove that there are at least 2^\aleph distinct topologies on X . Deduce that every infinite set has an uncountable number of distinct topologies on it.

[Hint. Prove that there at least 2^\aleph distinct topologies with precisely 3 open sets. For an introduction to cardinal numbers, see [Appendix 1](#).]

1.3 The Finite-Closed Topology

It is usual to define a topology on a set by stating which sets are open. However, sometimes it is more natural to describe the topology by saying which sets are closed. The next definition provides one such example.

1.3.1 Definition. Let X be any non-empty set. A topology \mathcal{T} on X is called the **finite-closed topology** or the **cofinite topology** if the closed subsets of X are X and all finite subsets of X ; that is, the open sets are \emptyset and all subsets of X which have finite complements.

Once again it is necessary to check that \mathcal{T} in [Definition 1.3.1](#) is indeed a topology; that is, that it satisfies each of the conditions of [Definitions 1.1.1](#).

Note that [Definition 1.3.1](#) does not say that every topology which has X and the finite subsets of X closed is the finite-closed topology. These must be the only closed sets. [Of course, in the discrete topology on any set X , the set X and all finite subsets of X are indeed closed, but so too are all other subsets of X .]

In the finite-closed topology all finite sets are closed. However, the following example shows that infinite subsets need not be open sets.

1.3.2 Example. If \mathbb{N} is the set of all positive integers, then sets such as $\{1\}$, $\{5, 6, 7\}$, $\{2, 4, 6, 8\}$ are finite and hence closed in the finite-closed topology. Thus their complements

$$\{2, 3, 4, 5, \dots\}, \{1, 2, 3, 4, 8, 9, 10, \dots\}, \{1, 3, 5, 7, 9, 10, 11, \dots\}$$

are open sets in the finite-closed topology. On the other hand, the set of even positive integers is not a closed set since it is not finite and hence its complement, the set of odd positive integers, is not an open set in the finite-closed topology.

So while all finite sets are closed, not all infinite sets are open. □

1.3.3 Example. Let \mathcal{T} be the finite-closed topology on a set X . If X has at least 3 distinct clopen subsets, prove that X is a finite set.

Proof.

We are given that \mathcal{T} is the finite-closed topology, and that there are at least 3 distinct clopen subsets.

We are required to prove that X is a finite set.

Recall that \mathcal{T} is the finite-closed topology means that the family of all closed sets consists of X and all finite subsets of X . Recall also that a set is clopen if and only if it is both closed and open.

Remember that in every topological space there are at least 2 clopen sets, namely X and \emptyset . (See the comment immediately following [Definition 1.2.6](#).) But we are told that in the space (X, \mathcal{T}) there are at least 3 clopen subsets. This implies that there is a clopen subset other than \emptyset and X . So we shall have a careful look at this other clopen set!

As our space (X, \mathcal{T}) has 3 distinct clopen subsets, we know that there is a clopen subset S of X such that $S \neq X$ and $S \neq \emptyset$. As S is open in (X, \mathcal{T}) , [Definition 1.2.4](#) implies that its complement $X \setminus S$ is a closed set.

Thus S and $X \setminus S$ are closed in the finite-closed topology \mathcal{T} . Therefore S and $X \setminus S$ are both finite, since neither equals X . But $X = S \cup (X \setminus S)$ and so X is the union of two finite sets. Thus X is a finite set, as required. \square

We now know three distinct topologies we can put on any infinite set – and there are many more. The three we know are the discrete topology, the indiscrete topology, and the finite-closed topology. So we must be careful always to specify the topology on a set.

For example, the set $\{n : n \geq 10\}$ is open in the finite-closed topology on the set of natural numbers, but is not open in the indiscrete topology. The set of odd natural numbers is open in the discrete topology on the set of natural numbers, but is not open in the finite-closed topology.

We shall now record some definitions which you have probably met before.

1.3.4 Definitions. Let f be a function from a set X into a set Y .

- (i) The function f is said to be **one-to-one** or **injective** if $f(x_1) = f(x_2)$ implies $x_1 = x_2$, for $x_1, x_2 \in X$;
- (ii) The function f is said to be **onto** or **surjective** if for each $y \in Y$ there exists an $x \in X$ such that $f(x) = y$;
- (iii) The function f is said to be **bijective** if it is both one-to-one and onto.

1.3.5 Definitions. Let f be a function from a set X into a set Y . The function f is said to **have an inverse** if there exists a function g of Y into X such that $g(f(x)) = x$, for all $x \in X$ and $f(g(y)) = y$, for all $y \in Y$. The function g is called an **inverse function** of f .

The proof of the following proposition is left as an exercise for you.

1.3.6 Proposition. Let f be a function from a set X into a set Y .

- (i) The function f has an inverse if and only if f is bijective.
- (ii) Let g_1 and g_2 be functions from Y into X . If g_1 and g_2 are both inverse functions of f , then $g_1 = g_2$; that is, $g_1(y) = g_2(y)$, for all $y \in Y$.
- (iii) Let g be a function from Y into X . Then g is an inverse function of f if and only if f is an inverse function of g .

Warning. It is a very common error for students to think that a function is one-to-one if “it maps one point to one point”.

All functions map one point to one point. Indeed this is part of the definition of a function.

A one-to-one function is a function that maps different points to different points. □

We now turn to a very important notion that you may not have met before.

1.3.7 Definition. Let f be a function from a set X into a set Y . If S is any subset of Y , then the set $f^{-1}(S)$ is defined by

$$f^{-1}(S) = \{x : x \in X \text{ and } f(x) \in S\}.$$

The subset $f^{-1}(S)$ of X is said to be the **inverse image** of S .

Note that an inverse function of $f: X \rightarrow Y$ exists if and only if f is bijective. But the inverse image of any subset of Y exists even if f is neither one-to-one nor onto. The next example demonstrates this.

1.3.8 Example. Let f be the function from the set of integers, \mathbb{Z} , into itself given by $f(z) = |z|$, for each $z \in \mathbb{Z}$.

The function f is not one-to-one, since $f(1) = f(-1)$.

It is also not onto, since there is no $z \in \mathbb{Z}$, such that $f(z) = -1$. So f is certainly not bijective. Hence, by [Proposition 1.3.6 \(i\)](#), f does not have an inverse function. However inverse images certainly exist. For example,

$$\begin{aligned} f^{-1}(\{1, 2, 3\}) &= \{-1, -2, -3, 1, 2, 3\} \\ f^{-1}(\{-5, 3, 5, 7, 9\}) &= \{-3, -5, -7, -9, 3, 5, 7, 9\}. \end{aligned}$$

□

We conclude this section with an interesting example.

1.3.9 Example. Let (Y, \mathcal{T}) be a topological space and X a non-empty set. Further, let f be a function from X into Y . Put $\mathcal{T}_1 = \{f^{-1}(S) : S \in \mathcal{T}\}$. Prove that \mathcal{T}_1 is a topology on X .

Proof.

Our task is to show that the collection of sets, \mathcal{T}_1 , is a topology on X ; that is, we have to show that \mathcal{T}_1 satisfies conditions (i), (ii) and (iii) of [Definitions 1.1.1](#)

$$\begin{aligned} X \in \mathcal{T}_1 & \text{ since } X = f^{-1}(Y) \text{ and } Y \in \mathcal{T}. \\ \emptyset \in \mathcal{T}_1 & \text{ since } \emptyset = f^{-1}(\emptyset) \text{ and } \emptyset \in \mathcal{T}. \end{aligned}$$

Therefore \mathcal{T}_1 has property (i) of [Definitions 1.1.1](#).

To verify condition (ii) of [Definitions 1.1.1](#), let $\{A_j : j \in J\}$ be a collection of members of \mathcal{T}_1 , for some index set J . We have to show that $\bigcup_{j \in J} A_j \in \mathcal{T}_1$.

As $A_j \in \mathcal{T}_1$, the definition of \mathcal{T}_1 implies that $A_j = f^{-1}(B_j)$, where $B_j \in \mathcal{T}$. Also $\bigcup_{j \in J} A_j = \bigcup_{j \in J} f^{-1}(B_j) = f^{-1}\left(\bigcup_{j \in J} B_j\right)$. [See [Exercises 1.3 # 1](#).]

Now $B_j \in \mathcal{T}$, for all $j \in J$, and so $\bigcup_{j \in J} B_j \in \mathcal{T}$, since \mathcal{T} is a topology on Y . Therefore, by the definition of \mathcal{T}_1 , $f^{-1}\left(\bigcup_{j \in J} B_j\right) \in \mathcal{T}_1$; that is, $\bigcup_{j \in J} A_j \in \mathcal{T}_1$.

So \mathcal{T}_1 has property (ii) of [Definitions 1.1.1](#).

[Warning. You are reminded that not all sets are countable. (See the Appendix for comments on countable sets.) So it would not suffice, in the above argument, to assume that sets $A_1, A_2, \dots, A_n, \dots$ are in \mathcal{T}_1 and show that their union $A_1 \cup A_2 \cup \dots \cup A_n \cup \dots$ is in \mathcal{T}_1 . This would prove only that the union of a countable number of sets in \mathcal{T}_1 lies in \mathcal{T}_1 , but would not show that \mathcal{T}_1 has property (ii) of [Definitions 1.1.1](#)— this property requires all unions, whether countable or uncountable, of sets in \mathcal{T}_1 to be in \mathcal{T}_1 .]

Finally, let A_1 and A_2 be in \mathcal{T}_1 . We have to show that $A_1 \cap A_2 \in \mathcal{T}_1$.

As $A_1, A_2 \in \mathcal{T}_1$, $A_1 = f^{-1}(B_1)$ and $A_2 = f^{-1}(B_2)$, where $B_1, B_2 \in \mathcal{T}$.

$$A_1 \cap A_2 = f^{-1}(B_1) \cap f^{-1}(B_2) = f^{-1}(B_1 \cap B_2). \quad \text{[See [Exercises 1.3 #1](#).]}$$

As $B_1 \cap B_2 \in \mathcal{T}$, we have $f^{-1}(B_1 \cap B_2) \in \mathcal{T}_1$. Hence $A_1 \cap A_2 \in \mathcal{T}_1$, and we have shown that \mathcal{T}_1 also has property (iii) of [Definitions 1.1.1](#).

So \mathcal{T}_1 is indeed a topology on X . □

Exercises 1.3

1. Let f be a function from a set X into a set Y . Then we stated in [Example 1.3.9](#) that

$$f^{-1}\left(\bigcup_{j \in J} B_j\right) = \bigcup_{j \in J} f^{-1}(B_j) \quad (1)$$

and

$$f^{-1}(B_1 \cap B_2) = f^{-1}(B_1) \cap f^{-1}(B_2) \quad (2)$$

for any subsets B_j of Y , and any index set J .

- (a) Prove that (1) is true.

[Hint. Start your proof by letting x be any element of the set on the left-hand side and show that it is in the set on the right-hand side. Then do the reverse.]

- (b) Prove that (2) is true.

- (c) Find (concrete) sets A_1, A_2, X , and Y and a function $f: X \rightarrow Y$ such that $f(A_1 \cap A_2) \neq f(A_1) \cap f(A_2)$, where $A_1 \subseteq X$ and $A_2 \subseteq X$.

2. Is the topology \mathcal{T} described in Exercises 1.1 #6 (ii) the finite-closed topology? (Justify your answer.)

T_1 -spaces

3. A topological space (X, \mathcal{T}) is said to be a **T_1 -space** if every singleton set $\{x\}$ is closed in (X, \mathcal{T}) . Show that precisely two of the following nine topological spaces are T_1 -spaces. (Justify your answer.)

- (i) a discrete space;
- (ii) an indiscrete space with at least two points;
- (iii) an infinite set with the finite-closed topology;
- (iv) [Example 1.1.2](#);
- (v) [Exercises 1.1 #5 \(i\)](#);
- (vi) [Exercises 1.1 #5 \(ii\)](#);
- (vii) [Exercises 1.1 #5 \(iii\)](#);
- (viii) [Exercises 1.1 #6 \(i\)](#);
- (ix) [Exercises 1.1 #6 \(ii\)](#).

4. Let \mathcal{T} be the finite-closed topology on a set X . If \mathcal{T} is also the discrete topology, prove that the set X is finite.

T₀-spaces and the Sierpinski Space

5. A topological space (X, \mathcal{T}) is said to be a **T₀-space** if for each pair of distinct points a, b in X , either² there exists an open set containing a and not b , or there exists an open set containing b and not a .
- (i) Prove that every T₁-space is a T₀-space.
- (ii) Which of (i)–(vi) in Exercise 3 above are T₀-spaces? (Justify your answer.)
- (iii) Put a topology \mathcal{T} on the set $X = \{0, 1\}$ so that (X, \mathcal{T}) will be a T₀-space but not a T₁-space. [The topological space you obtain is called the **Sierpiński space**.]
- (iv) Prove that each of the topological spaces described in [Exercises 1.1 #6](#) is a T₀-space. (Observe that in Exercise 3 above we saw that neither is a T₁-space.)

Countable-Closed Topology

6. Let X be any infinite set. The **countable-closed topology** is defined to be the topology having as its closed sets X and all countable subsets of X . Prove that this is indeed a topology on X .

²**You are reminded that the use of “or” in mathematics is different from that in everyday English. In mathematics, “or” is not exclusive.** See the comments on this in [Chapter 0](#).

Intersection of Two Topologies

7. Let \mathcal{T}_1 and \mathcal{T}_2 be two topologies on a set X . Prove each of the following statements.
- (i) If \mathcal{T}_3 is defined by $\mathcal{T}_3 = \mathcal{T}_1 \cup \mathcal{T}_2$, then \mathcal{T}_3 is not necessarily a topology on X . (Justify your answer, by finding a concrete example.)
 - (ii) If \mathcal{T}_4 is defined by $\mathcal{T}_4 = \mathcal{T}_1 \cap \mathcal{T}_2$, then \mathcal{T}_4 is a topology on X . (The topology \mathcal{T}_4 is said to be the **intersection** of the topologies \mathcal{T}_1 and \mathcal{T}_2 .)
 - (iii) If (X, \mathcal{T}_1) and (X, \mathcal{T}_2) are T_1 -spaces, then (X, \mathcal{T}_4) is also a T_1 -space.
 - (iv) If (X, \mathcal{T}_1) and (X, \mathcal{T}_2) are T_0 -spaces, then (X, \mathcal{T}_4) is not necessarily a T_0 -space. (Justify your answer by finding a concrete example.)
 - (v) If $\mathcal{T}_1, \mathcal{T}_2, \dots, \mathcal{T}_n$ are topologies on a set X , then $\mathcal{T} = \bigcap_{i=1}^n \mathcal{T}_i$ is a topology on X .
 - (vi) If for each $i \in I$, for some index set I , each \mathcal{T}_i is a topology on the set X , then $\mathcal{T} = \bigcap_{i \in I} \mathcal{T}_i$ is a topology on X .

Distinct T_0 -Topologies on a Finite Set

8. In Wikipedia, http://en.wikipedia.org/wiki/Finite_topological_space, as we noted in [Exercises 1.2 #7](#), it says that the number of topologies on a finite set with $n \in \mathbb{N}$ points can be quite large, even for small n . This is also true even for T_0 -spaces as defined in [Exercises 1.3 #5](#). Indeed that same Wikipedia source says, that if $n = 3$, there are 19 distinct T_0 -spaces; for $n = 4$, there are 219 distinct T_0 -spaces; for $n = 5$, there are 4231 distinct T_0 -spaces. Prove, using mathematical induction, that as n increases, the number of T_0 -spaces increases.
- [Hint. It suffices to show that if there are M T_0 -spaces with n points, then there are at least $M + 1$ T_0 -spaces with $n + 1$ points.]

9. A topological space (X, \mathcal{T}) is said to be a **door space** if every subset of X is either an open set or a closed set (or both).
- (i) Is a discrete space a door space?
 - (ii) Is an indiscrete space a door space?
 - (iii) If X is an infinite set and \mathcal{T} is the finite-closed topology, is (X, \mathcal{T}) a door space?
 - (iv) Let X be the set $\{a, b, c, d\}$. identify those topologies \mathcal{T} on X which make it into a door space?

Saturated Sets

10. A subset S of a topological space (X, \mathcal{T}) is said to be **saturated** if it is an intersection of open sets in (X, \mathcal{T}) .
- (i) Verify that every open set is a saturated set.
 - (ii) Verify that in a T_1 -space every set is a saturated set.
 - (iii) Give an example of a topological space which has at least one subset which is not saturated.
 - (iv) Is it true that if the topological space (X, \mathcal{T}) is such that every subset is saturated, then (X, \mathcal{T}) is a T_1 -space?

1.4 Postscript

In this chapter we introduced the fundamental notion of a topological space. As examples we saw various finite topological spaces³, as well as discrete spaces, indiscrete spaces and spaces with the finite-closed topology. None of these is a particularly important example as far as applications are concerned. However, in [Exercises 4.3 #8](#), it is noted that every infinite topological space “contains” an infinite topological space with one of the five topologies: the indiscrete topology, the discrete topology, the finite-closed topology, the initial segment topology, or the final segment topology of [Exercises 1.1 #6](#). In the next chapter we describe the very important euclidean topology.

³By a **finite topological space** we mean a topological space (X, \mathcal{T}) where the set X is finite.

En route we met the terms “open set” and “closed set” and we were warned that these names can be misleading. Sets can be both open and closed, neither open nor closed, open but not closed, or closed but not open. It is important to remember that we cannot prove that a set is open by proving that it is not closed.

Other than the definitions of topology, topological space, open set, and closed set the most significant topic covered was that of writing proofs.

In the opening comments of this chapter we pointed out the importance of learning to write proofs. In [Example 1.1.8](#), [Proposition 1.1.9](#), and [Example 1.3.3](#) we have seen how to “think through” a proof. It is essential that you develop your own skill at writing proofs. Good exercises to try for this purpose include [Exercises 1.1 #8](#), [Exercises 1.2 #2,4](#), and [Exercises 1.3 #1,4](#).

If you have not already done so, you should watch the first two of the YouTube videos on proofs. They are called

“Topology Without Tears – Video 4a – Writing Proofs in Mathematics” and “Topology Without Tears – Video 4b – Writing Proofs in Mathematics”

and can be found at

<http://youtu.be/T1snRQEQuEk> and <http://youtu.be/VrAwuszHzTw>

or on the Chinese Youku site at

<http://tinyurl.com/mwpmlqs> and <http://tinyurl.com/n3jjmsm>

or by following the relevant link from

<http://www.topologywithouttears.net>.

It would also be quite helpful to watch the fourth video on writing proofs. It is on writing proofs which use Mathematical Induction. It is called “Topology Without Tears - Video 4d - Writing Proofs in Mathematics” and can be found at

<http://youtu.be/gu0Z029ebo0>

Some students are confused by the notion of topology as it involves “sets of sets”. To check your understanding, do [Exercises 1.1 #3](#).

The exercises included the notions of T_0 -space and T_1 -space which will be formally introduced later. These are known as **separation properties**.

Finally we emphasize the importance of inverse images. These are dealt with in [Example 1.3.9](#) and [Exercises 1.3 #1](#). Our definition of continuous mapping will rely on inverse images.

Chapter 2

The Euclidean Topology

Introduction

In a movie or a novel there are usually a few central characters about whom the plot revolves. In the story of topology, the euclidean topology on the set of real numbers is one of the central characters. Indeed it is such a rich example that we shall frequently return to it for inspiration and further examination.

Let \mathbb{R} denote the set of all real numbers. In [Chapter 1](#) we defined three topologies that can be put on any set: the discrete topology, the indiscrete topology and the finite-closed topology. So we know three topologies that can be put on the set \mathbb{R} . Six other topologies on \mathbb{R} were defined in [Exercises 1.1 #5](#) and [#9](#). In this chapter we describe a much more important and interesting topology on \mathbb{R} which is known as the euclidean topology.

An analysis of the euclidean topology leads us to the notion of “basis for a topology”. In the study of Linear Algebra we learn that every vector space has a basis and every vector is a linear combination of members of the basis. Similarly, in a topological space every open set can be expressed as a union of members of the basis. Indeed, a set is open if and only if it is a union of members of the basis.

In order to understand this chapter, you should familiarize yourself with the content of the first section of [Appendix 1](#); that is A1.1. This is supplemented by the videos "Topology Without Tears - Video 2a & 2b - Infinite Set Theory" which are on YouTube at <http://youtu.be/9h83ZJeiecg> & <http://youtu.be/QPSRB4Fhzko>; on Youku at <http://tinyurl.com/m4dlzhh> & <http://tinyurl.com/kf9lp8e>; and have links from <http://www.topologywithouttears.net>.

2.1 The Euclidean Topology on \mathbb{R}

2.1.1 Definition. A subset S of \mathbb{R} is said to be open in the **euclidean topology on \mathbb{R}** if it has the following property:

(*) For each $x \in S$, there exist a, b in \mathbb{R} , with $a < b$, such that $x \in (a, b) \subseteq S$.

Notation. Whenever we refer to the topological space \mathbb{R} without specifying the topology, we mean \mathbb{R} with the euclidean topology.

2.1.2 Remarks. (i) The “euclidean topology” \mathcal{T} is a topology.

Proof.

We are required to show that \mathcal{T} satisfies conditions (i), (ii), and (iii) of [Definitions 1.1.1](#).

We are given that a set is in \mathcal{T} if and only if it has property (*).

Firstly, we show that $\mathbb{R} \in \mathcal{T}$. Let $x \in \mathbb{R}$. If we put $a = x - 1$ and $b = x + 1$, then $x \in (a, b) \subseteq \mathbb{R}$; that is, \mathbb{R} has property (*) and so $\mathbb{R} \in \mathcal{T}$. Secondly, $\emptyset \in \mathcal{T}$ as \emptyset has property (*) by default.

Now let $\{A_j : j \in J\}$, for some index set J , be a family of members of \mathcal{T} . Then we have to show that $\bigcup_{j \in J} A_j \in \mathcal{T}$; that is, we have to show that $\bigcup_{j \in J} A_j$ has property (*). Let $x \in \bigcup_{j \in J} A_j$. Then $x \in A_k$, for some $k \in J$. As $A_k \in \mathcal{T}$, there exist a and b in \mathbb{R} with $a < b$ such that $x \in (a, b) \subseteq A_k$. As $k \in J$, $A_k \subseteq \bigcup_{j \in J} A_j$ and so $x \in (a, b) \subseteq \bigcup_{j \in J} A_j$. Hence $\bigcup_{j \in J} A_j$ has property (*) and thus is in \mathcal{T} , as required.

Finally, let A_1 and A_2 be in \mathcal{T} . We have to prove that $A_1 \cap A_2 \in \mathcal{T}$. So let $y \in A_1 \cap A_2$. Then $y \in A_1$. As $A_1 \in \mathcal{T}$, there exist a and b in \mathbb{R} with $a < b$ such that $y \in (a, b) \subseteq A_1$. Also $y \in A_2 \in \mathcal{T}$. So there exist c and d in \mathbb{R} with $c < d$ such that $y \in (c, d) \subseteq A_2$. Let e be the greater of a and c , and f the smaller of b and d . It is easily checked that $e < y < f$, and so $y \in (e, f)$. As $(e, f) \subseteq (a, b) \subseteq A_1$ and $(e, f) \subseteq (c, d) \subseteq A_2$, we deduce that $y \in (e, f) \subseteq A_1 \cap A_2$. Hence $A_1 \cap A_2$ has property (*) and so is in \mathcal{T} .

Thus \mathcal{T} is indeed a topology on \mathbb{R} . □

We now proceed to describe the open sets and the closed sets in the euclidean topology on \mathbb{R} . In particular, we shall see that all open intervals are indeed open sets in this topology and all closed intervals are closed sets.

(ii) Let $r, s \in \mathbb{R}$ with $r < s$. In the euclidean topology \mathcal{T} on \mathbb{R} , the open interval (r, s) does indeed belong to \mathcal{T} and so is an open set.

Proof.

We are given the open interval (r, s) .

We must show that (r, s) is open in the euclidean topology; that is, we have to show that (r, s) has property (*) of [Definition 2.1.1](#).

So we shall begin by letting $x \in (r, s)$. We want to find a and b in \mathbb{R} with $a < b$ such that $x \in (a, b) \subseteq (r, s)$.

Let $x \in (r, s)$. Choose $a = r$ and $b = s$. Then clearly

$$x \in (a, b) \subseteq (r, s).$$

So (r, s) is an open set in the euclidean topology. □

(iii) The open intervals (r, ∞) and $(-\infty, r)$ are open sets in \mathbb{R} , for every real number r .

Proof.

Firstly, we shall show that (r, ∞) is an open set; that is, that it has property (*).

To show this we let $x \in (r, \infty)$ and seek $a, b \in \mathbb{R}$ such that

$$x \in (a, b) \subseteq (r, \infty).$$

Let $x \in (r, \infty)$. Put $a = r$ and $b = x + 1$. Then $x \in (a, b) \subseteq (r, \infty)$ and so $(r, \infty) \in \mathcal{T}$.

A similar argument shows that $(-\infty, r)$ is an open set in \mathbb{R} . □

(iv) It is important to note that while every open interval is an open set in \mathbb{R} , the converse is false. **Not all open sets in \mathbb{R} are intervals.** For example, the set $(1, 3) \cup (5, 6)$ is an open set in \mathbb{R} , but it is not an open interval. Even the set $\bigcup_{n=1}^{\infty} (2n, 2n + 1)$ is an open set in \mathbb{R} . \square

(v) For each c and d in \mathbb{R} with $c < d$, the closed interval $[c, d]$ is not an open set in \mathbb{R} .¹

Proof.

We have to show that $[c, d]$ does not have property (*).

To do this it suffices to find any one x such that there is no a, b having property (*).

Obviously c and d are very special points in the interval $[c, d]$. So we shall choose $x = c$ and show that no a, b with the required property exist.

We use the method of proof called **Proof by Contradiction**. We **suppose** that a and b exist with the required property and show that this leads to a contradiction, that is something which is false.

Consequently **the supposition is false!** Hence no such a and b exist. Thus $[c, d]$ does not have property (*) and so is not an open set. \square

Observe that $c \in [c, d]$. **Suppose** there exist a and b in \mathbb{R} with $a < b$ such that $c \in (a, b) \subseteq [c, d]$. Then $c \in (a, b)$ implies $a < c < b$ and so $a < \frac{c+a}{2} < c < b$. Thus $\frac{c+a}{2} \in (a, b)$ and $\frac{c+a}{2} \notin [c, d]$. Hence $(a, b) \not\subseteq [c, d]$, which is a contradiction. So there do not exist a and b such that $c \in (a, b) \subseteq [c, d]$. Hence $[c, d]$ does not have property (*) and so $[c, d] \notin \mathcal{T}$. \square

(vi) For each a and b in \mathbb{R} with $a < b$, the closed interval $[a, b]$ is a closed set in the euclidean topology on \mathbb{R} .

Proof. To see that it is closed we have to observe only that its complement $(-\infty, a) \cup (b, \infty)$, being the union of two open sets, is an open set. \square

¹You should watch the YouTube video "Topology Without Tears - Video 4c - Writing Proofs in Mathematics" which discusses Proof by Contradiction. See <http://youtu.be/T4384JAS3L4>.

(vii) Each singleton set $\{a\}$ is closed in \mathbb{R} .

Proof. The complement of $\{a\}$ is the union of the two open sets $(-\infty, a)$ and (a, ∞) and so is open. Therefore $\{a\}$ is closed in \mathbb{R} , as required.

[In the terminology of [Exercises 1.3 #3](#), this result says that \mathbb{R} is a T_1 -space.]□

(viii) Note that we could have included (vii) in (vi) simply by replacing “ $a < b$ ” by “ $a \leq b$ ”. The singleton set $\{a\}$ is just the degenerate case of the closed interval $[a, b]$. □

(ix) The set \mathbb{Z} of all integers is a closed subset of \mathbb{R} .

Proof. The complement of \mathbb{Z} is the union $\bigcup_{n=-\infty}^{\infty} (n, n+1)$ of open subsets $(n, n+1)$ of \mathbb{R} and so is open in \mathbb{R} . Therefore \mathbb{Z} is closed in \mathbb{R} . □

(x) The set \mathbb{Q} of all rational numbers is neither a closed subset of \mathbb{R} nor an open subset of \mathbb{R} .

Proof.

We shall show that \mathbb{Q} is not an open set by proving that it does not have property (*).

To do this it suffices to show that \mathbb{Q} does not contain any interval (a, b) , with $a < b$.

Suppose that $(a, b) \subseteq \mathbb{Q}$, where a and b are in \mathbb{R} with $a < b$. Between any two distinct real numbers there is an irrational number. (Can you prove this?) Therefore there exists $c \in (a, b)$ such that $c \notin \mathbb{Q}$. This contradicts $(a, b) \subseteq \mathbb{Q}$. Hence \mathbb{Q} does not contain any interval (a, b) , and so is not an open set.

To prove that \mathbb{Q} is not a closed set it suffices to show that $\mathbb{R} \setminus \mathbb{Q}$ is not an open set. Using the fact that between any two distinct real numbers there is a rational number we see that $\mathbb{R} \setminus \mathbb{Q}$ does not contain any interval (a, b) with $a < b$. So $\mathbb{R} \setminus \mathbb{Q}$ is not open in \mathbb{R} and hence \mathbb{Q} is not closed in \mathbb{R} . □

(xi) In [Chapter 3](#) we shall prove that the only clopen subsets of \mathbb{R} are the trivial ones, namely \mathbb{R} and \emptyset . □

Exercises 2.1

1. Prove that if $a, b \in \mathbb{R}$ with $a < b$ then neither $[a, b)$ nor $(a, b]$ is an open subset of \mathbb{R} . Also show that neither is a closed subset of \mathbb{R} .
2. Prove that the sets $[a, \infty)$ and $(-\infty, a]$ are closed subsets of \mathbb{R} .
3. Show, by example, that the union of an infinite number of closed subsets of \mathbb{R} is not necessarily a closed subset of \mathbb{R} .
4. Prove each of the following statements.
 - (i) The set \mathbb{Z} of all integers is not an open subset of \mathbb{R} .
 - (ii) The set \mathbb{P} of all prime numbers is a closed subset of \mathbb{R} but not an open subset of \mathbb{R} .
 - (iii) The set \mathbb{I} of all irrational numbers is neither a closed subset nor an open subset of \mathbb{R} .
5. If F is a non-empty finite subset of \mathbb{R} , show that F is closed in \mathbb{R} but that F is not open in \mathbb{R} .
6. If F is a non-empty countable subset of \mathbb{R} , prove that F is not an open set, but that F may or may not be a closed set depending on the choice of F .
7. (i) Let $S = \{0, 1, 1/2, 1/3, 1/4, 1/5, \dots, 1/n, \dots\}$. Prove that the set S is closed in the euclidean topology on \mathbb{R} .
 - (ii) Is the set $T = \{1, 1/2, 1/3, 1/4, 1/5, \dots, 1/n, \dots\}$ closed in \mathbb{R} ?
 - (iii) Is the set $\{\sqrt{2}, 2\sqrt{2}, 3\sqrt{2}, \dots, n\sqrt{2}, \dots\}$ closed in \mathbb{R} ?

F_σ -Sets and G_δ -Sets

8. (i) Let (X, \mathcal{T}) be a topological space. A subset S of X is said to be an **F_σ -set** if it is the union of a countable number of closed sets. Prove that all open intervals (a, b) and all closed intervals $[a, b]$, are F_σ -sets in \mathbb{R} .
 - (ii) Let (X, \mathcal{T}) be a topological space. A subset T of X is said to be a **G_δ -set** if it is the intersection of a countable number of open sets. Prove that all open intervals (a, b) and all closed intervals $[a, b]$ are G_δ -sets in \mathbb{R} .
 - (iii) Prove that the set \mathbb{Q} of rationals is an F_σ -set in \mathbb{R} . (In [Exercises 6.5 #3](#) we prove that \mathbb{Q} is not a G_δ -set in \mathbb{R} .)
 - (iv) Verify that the complement of an F_σ -set is a G_δ -set and the complement of a G_δ -set is an F_σ -set.

2.2 Basis for a Topology

Remarks 2.1.2 allow us to describe the euclidean topology on \mathbb{R} in a much more convenient manner. To do this, we introduce the notion of a basis for a topology.

2.2.1 Proposition. A subset S of \mathbb{R} is open if and only if it is a union of open intervals.

Proof.

We are required to prove that S is open if and only if it is a union of open intervals; that is, we have to show that

- (i) if S is a union of open intervals, then it is an open set, and
- (ii) if S is an open set, then it is a union of open intervals.

Assume that S is a union of open intervals; that is, there exist open intervals (a_j, b_j) , where j belongs to some index set J , such that $S = \bigcup_{j \in J} (a_j, b_j)$. By Remarks 2.1.2 (ii) each open interval (a_j, b_j) is an open set. Thus S is a union of open sets and so S is an open set.

Conversely, assume that S is open in \mathbb{R} . Then for each $x \in S$, there exists an interval $I_x = (a, b)$ such that $x \in I_x \subseteq S$. We now claim that $S = \bigcup_{x \in S} I_x$.

We are required to show that the two sets S and $\bigcup_{x \in S} I_x$ are equal.

These sets are shown to be equal by proving that

- (i) if $y \in S$, then $y \in \bigcup_{x \in S} I_x$, and
- (ii) if $z \in \bigcup_{x \in S} I_x$, then $z \in S$.

[Note that (i) is equivalent to the statement $S \subseteq \bigcup_{x \in S} I_x$, while (ii) is equivalent to $\bigcup_{x \in S} I_x \subseteq S$.]

Firstly let $y \in S$. Then $y \in I_y$. So $y \in \bigcup_{x \in S} I_x$, as required. Secondly, let $z \in \bigcup_{x \in S} I_x$. Then $z \in I_t$, for some $t \in S$. As each $I_x \subseteq S$, we see that $I_t \subseteq S$ and so $z \in S$. Hence $S = \bigcup_{x \in S} I_x$, and we have that S is a union of open intervals, as required. □

The above proposition tells us that in order to describe the topology of \mathbb{R} it suffices to say that all intervals (a, b) are open sets. Every other open set is a union of these open sets. This leads us to the following definition.

2.2.2 Definition. Let (X, \mathcal{T}) be a topological space. A collection \mathcal{B} of open subsets of X is said to be a **basis** for the topology \mathcal{T} if every open set is a union of members of \mathcal{B} .

If \mathcal{B} is a basis for a topology \mathcal{T} on a set X then a subset U of X is in \mathcal{T} if and only if it is a union of members of \mathcal{B} . So \mathcal{B} “generates” the topology \mathcal{T} in the following sense: if we are told what sets are members of \mathcal{B} then we can determine the members of \mathcal{T} – they are just all the sets which are unions of members of \mathcal{B} .

2.2.3 Example. Let $\mathcal{B} = \{(a, b) : a, b \in \mathbb{R}, a < b\}$. Then \mathcal{B} is a basis for the euclidean topology on \mathbb{R} , by [Proposition 2.2.1](#). □

2.2.4 Example. Let (X, \mathcal{T}) be a discrete space and \mathcal{B} the family of all singleton subsets of X ; that is, $\mathcal{B} = \{\{x\} : x \in X\}$. Then, by [Proposition 1.1.9](#), \mathcal{B} is a basis for \mathcal{T} . □

2.2.5 Example. Let $X = \{a, b, c, d, e, f\}$ and

$$\mathcal{T}_1 = \{X, \emptyset, \{a\}, \{c, d\}, \{a, c, d\}, \{b, c, d, e, f\}\}.$$

Then $\mathcal{B} = \{\{a\}, \{c, d\}, \{b, c, d, e, f\}\}$ is a basis for \mathcal{T}_1 as $\mathcal{B} \subseteq \mathcal{T}_1$ and every member of \mathcal{T}_1 can be expressed as a union of members of \mathcal{B} . (Observe that \emptyset is an empty union of members of \mathcal{B} .)

Note that \mathcal{T}_1 itself is also a basis for \mathcal{T}_1 . □

2.2.6 Remark. Observe that if (X, \mathcal{T}) is a topological space then $\mathcal{B} = \mathcal{T}$ is a basis for the topology \mathcal{T} . So, for example, the set of all subsets of X is a basis for the discrete topology on X .

We see, therefore, that [there can be many different bases for the same topology](#). Indeed if \mathcal{B} is a basis for a topology \mathcal{T} on a set X and \mathcal{B}_1 is a collection of subsets of X such that $\mathcal{B} \subseteq \mathcal{B}_1 \subseteq \mathcal{T}$, then \mathcal{B}_1 is also a basis for \mathcal{T} . [Verify this.] \square

As indicated above the notion of “basis for a topology” allows us to define topologies. However the following example shows that we must be careful.

2.2.7 Example. Let $X = \{a, b, c\}$ and $\mathcal{B} = \{\{a\}, \{c\}, \{a, b\}, \{b, c\}\}$. Then \mathcal{B} is not a basis for any topology on X . To see this, suppose that \mathcal{B} is a basis for a topology \mathcal{T} . Then \mathcal{T} consists of all unions of sets in \mathcal{B} ; that is,

$$\mathcal{T} = \{X, \emptyset, \{a\}, \{c\}, \{a, c\}, \{a, b\}, \{b, c\}\}.$$

(Once again we use the fact that \emptyset is an empty union of members of \mathcal{B} and so $\emptyset \in \mathcal{T}$.)

However, \mathcal{T} is not a topology since the set $\{b\} = \{a, b\} \cap \{b, c\}$ is not in \mathcal{T} and so \mathcal{T} does not have property (iii) of [Definitions 1.1.1](#). This is a contradiction, and so our supposition is false. Thus \mathcal{B} is not a basis for any topology on X . \square

Thus we are led to ask: if \mathcal{B} is a collection of subsets of X , under what conditions is \mathcal{B} a basis for a topology? This question is answered by [Proposition 2.2.8](#).

2.2.8 Proposition. Let X be a non-empty set and let \mathcal{B} be a collection of subsets of X . Then \mathcal{B} is a basis for a topology on X if and only if \mathcal{B} has the following properties:

(a) $X = \bigcup_{B \in \mathcal{B}} B$, and

(b) for any $B_1, B_2 \in \mathcal{B}$, the set $B_1 \cap B_2$ is a union of members of \mathcal{B} .

Proof. If \mathcal{B} is a basis for a topology \mathcal{T} then \mathcal{T} must have the properties (i), (ii), and (iii) of [Definitions 1.1.1](#). In particular X must be an open set and the intersection of any two open sets must be an open set. As the open sets are just the unions of members of \mathcal{B} , this implies that (a) and (b) above are true.

Conversely, assume that \mathcal{B} has properties (a) and (b) and let \mathcal{T} be the collection of all subsets of X which are unions of members of \mathcal{B} . We shall show that \mathcal{T} is a topology on X . (If so then \mathcal{B} is obviously a basis for this topology \mathcal{T} and the proposition is true.)

By (a), $X = \bigcup_{B \in \mathcal{B}} B$ and so $X \in \mathcal{T}$. Note that \emptyset is an empty union of members of \mathcal{B} and so $\emptyset \in \mathcal{T}$. So we see that \mathcal{T} does have property (i) of [Definitions 1.1.1](#).

Now let $\{T_j\}$ be a family of members of \mathcal{T} . Then each T_j is a union of members of \mathcal{B} . Hence the union of all the T_j is also a union of members of \mathcal{B} and so is in \mathcal{T} . Thus \mathcal{T} also satisfies condition (ii) of [Definitions 1.1.1](#).

Finally let C and D be in \mathcal{T} . We need to verify that $C \cap D \in \mathcal{T}$. But $C = \bigcup_{k \in K} B_k$, for some index set K and sets $B_k \in \mathcal{B}$. Also $D = \bigcup_{j \in J} B_j$, for some index set J and $B_j \in \mathcal{B}$. Therefore

$$C \cap D = \left(\bigcup_{k \in K} B_k \right) \cap \left(\bigcup_{j \in J} B_j \right) = \bigcup_{k \in K, j \in J} (B_k \cap B_j).$$

You should verify that the two expressions for $C \cap D$ are indeed equal!

In the finite case this involves statements like

$$(B_1 \cup B_2) \cap (B_3 \cup B_4) = (B_1 \cap B_3) \cup (B_1 \cap B_4) \cup (B_2 \cap B_3) \cup (B_2 \cap B_4).$$

By our assumption (b), each $B_k \cap B_j$ is a union of members of \mathcal{B} and so $C \cap D$ is a union of members of \mathcal{B} . Thus $C \cap D \in \mathcal{T}$. So \mathcal{T} has property (iii) of [Definition 1.1.1](#). Hence \mathcal{T} is indeed a topology, and \mathcal{B} is a basis for this topology, as required. \square

[Proposition 2.2.8](#) is a very useful result. It allows us to define topologies by simply writing down a basis. This is often easier than trying to describe all of the open sets.

We shall now use this Proposition to define a topology on the plane. This topology is known as the “euclidean topology”.

2.2.9 Example. Let \mathcal{B} be the collection of all “open rectangles” $\{\langle x, y \rangle : \langle x, y \rangle \in \mathbb{R}^2, a < x < b, c < y < d\}$ in the plane which have each side parallel to the X - or Y -axis.

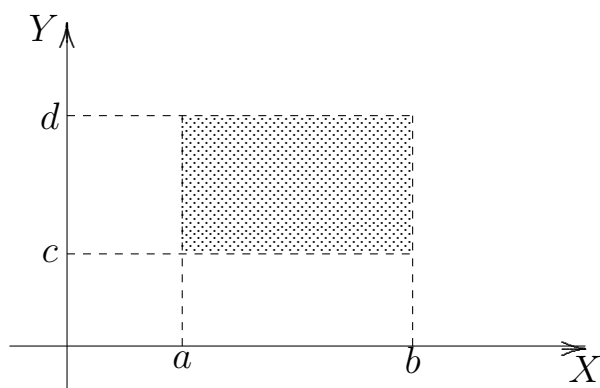

Then \mathcal{B} is a basis for a topology on the plane. This topology is called the euclidean topology.

Whenever we use the symbol \mathbb{R}^2 we mean the plane, and if we refer to \mathbb{R}^2 as a topological space without explicitly saying what the topology is, we mean the plane with the euclidean topology.

To see that \mathcal{B} is indeed a basis for a topology, observe that (i) the plane is the union of all of the open rectangles, and (ii) the intersection of any two rectangles is a rectangle. [By “rectangle” we mean one with sides parallel to the axes.] So the conditions of Proposition 2.2.8 are satisfied and hence \mathcal{B} is a basis for a topology. \square

2.2.10 Remark. By generalizing [Example 2.2.9](#) we see how to put a topology on $\mathbb{R}^n = \{\langle x_1, x_2, \dots, x_n \rangle : x_i \in \mathbb{R}, i = 1, \dots, n\}$, for each integer $n > 2$. We let \mathcal{B} be the collection of all subsets $\{\langle x_1, x_2, \dots, x_n \rangle \in \mathbb{R}^n : a_i < x_i < b_i, i = 1, 2, \dots, n\}$ of \mathbb{R}^n with sides parallel to the axes. This collection \mathcal{B} is a basis for the **euclidean topology** on \mathbb{R}^n . \square

Exercises 2.2

1. In this exercise you will prove that disc $\{\langle x, y \rangle : x^2 + y^2 < 1\}$ is an open subset of \mathbb{R}^2 , and then that every open disc in the plane is an open set.

(i) Let $\langle a, b \rangle$ be any point in the disc $D = \{\langle x, y \rangle : x^2 + y^2 < 1\}$. Put $r = \sqrt{a^2 + b^2}$. Let $R_{\langle a, b \rangle}$ be the open rectangle with vertices at the points $\langle a \pm \frac{1-r}{8}, b \pm \frac{1-r}{8} \rangle$. Verify that $R_{\langle a, b \rangle} \subset D$.

(ii) Using (i) show that

$$D = \bigcup_{\langle a, b \rangle \in D} R_{\langle a, b \rangle}.$$

(iii) Deduce from (ii) that D is an open set in \mathbb{R}^2 .

(iv) Show that every disc $\{\langle x, y \rangle : (x - a)^2 + (y - b)^2 < c^2, a, b, c \in \mathbb{R}\}$ is open in \mathbb{R}^2 .

2. In this exercise you will show that the collection of all open discs in \mathbb{R}^2 is a basis for a topology on \mathbb{R}^2 . [Later we shall see that this is the euclidean topology.]

(i) Let D_1 and D_2 be any open discs in \mathbb{R}^2 with $D_1 \cap D_2 \neq \emptyset$. If $\langle a, b \rangle$ is any point in $D_1 \cap D_2$, show that there exists an open disc $D_{\langle a, b \rangle}$ with centre $\langle a, b \rangle$ such that $D_{\langle a, b \rangle} \subset D_1 \cap D_2$.

[Hint: draw a picture and use a method similar to that of Exercise 1 (i).]

(ii) Show that

$$D_1 \cap D_2 = \bigcup_{\langle a, b \rangle \in D_1 \cap D_2} D_{\langle a, b \rangle}.$$

(iii) Using (ii) and Proposition 2.2.8, prove that the collection of all open discs in \mathbb{R}^2 is a basis for a topology on \mathbb{R}^2 .

3. Let \mathcal{B} be the collection of all open intervals (a, b) in \mathbb{R} with $a < b$ and a and b rational numbers. Prove that \mathcal{B} is a basis for the euclidean topology on \mathbb{R} . [Compare this with Proposition 2.2.1 and Example 2.2.3 where a and b were not necessarily rational.]

[Hint: do not use [Proposition 2.2.8](#) as this would show only that \mathcal{B} is a basis for some topology not necessarily a basis for the euclidean topology.]

Second Axiom of Countability

4. A topological space (X, \mathcal{T}) is said to satisfy the **second axiom of countability** or to be **second countable** if there exists a basis \mathcal{B} for \mathcal{T} , where \mathcal{B} consists of only a countable number of sets.

(i) Using [Exercise 3](#) above show that \mathbb{R} satisfies the second axiom of countability.

(ii) Prove that the discrete topology on an uncountable set does not satisfy the second axiom of countability.

[Hint: It is not enough to show that one particular basis is uncountable. You must prove that every basis for this topology is uncountable.]

(iii) Prove that \mathbb{R}^n satisfies the second axiom of countability, for each positive integer n .

(iv) Let (X, \mathcal{T}) be the set of all integers with the finite-closed topology. Does the space (X, \mathcal{T}) satisfy the second axiom of countability?

5. Prove the following statements.

(i) Let m and c be real numbers. Then the line $L = \{\langle x, y \rangle : y = mx + c\}$ is a closed subset of \mathbb{R}^2 .

(ii) Let \mathbb{S}^1 be the unit circle given by $\mathbb{S}^1 = \{\langle x, y \rangle \in \mathbb{R}^2 : x^2 + y^2 = 1\}$. Then \mathbb{S}^1 is a closed subset of \mathbb{R}^2 .

(iii) Let \mathbb{S}^n be the unit n -sphere given by

$$\mathbb{S}^n = \{\langle x_1, x_2, \dots, x_n, x_{n+1} \rangle \in \mathbb{R}^{n+1} : x_1^2 + x_2^2 + \dots + x_{n+1}^2 = 1\}.$$

Then \mathbb{S}^n is a closed subset of \mathbb{R}^{n+1} .

(iv) Let B^n be the closed unit n -ball given by

$$B^n = \{\langle x_1, x_2, \dots, x_n \rangle \in \mathbb{R}^n : x_1^2 + x_2^2 + \dots + x_n^2 \leq 1\}.$$

Then B^n is a closed subset of \mathbb{R}^n .

(v) The curve $C = \{\langle x, y \rangle \in \mathbb{R}^2 : xy = 1\}$ is a closed subset of \mathbb{R}^2 .

Product Topology

6. Let \mathcal{B}_1 be a basis for a topology \mathcal{T}_1 on a set X and \mathcal{B}_2 a basis for a topology \mathcal{T}_2 on a set Y . The set $X \times Y$ consists of all ordered pairs $\langle x, y \rangle$, $x \in X$ and $y \in Y$. Let \mathcal{B} be the collection of subsets of $X \times Y$ consisting of all the sets $B_1 \times B_2$ where $B_1 \in \mathcal{B}_1$ and $B_2 \in \mathcal{B}_2$. Prove that \mathcal{B} is a basis for a topology on $X \times Y$. The topology so defined is called the **product topology** on $X \times Y$. [Hint: See [Example 2.2.9](#).]
7. Using [Exercise 3](#) above and [Exercises 2.1 #8](#), prove that every open subset of \mathbb{R} is an F_σ -set and a G_δ -set.

2.3 Basis for a Given Topology

[Proposition 2.2.8](#) told us under what conditions a collection \mathcal{B} of subsets of a set X is a basis for some topology on X . However sometimes we are given a topology \mathcal{T} on X and we want to know whether \mathcal{B} is a basis for this specific topology \mathcal{T} . To verify that \mathcal{B} is a basis for \mathcal{T} we could simply apply [Definition 2.2.2](#) and show that every member of \mathcal{T} is a union of members of \mathcal{B} . However, [Proposition 2.3.2](#) provides us with an alternative method.

But first we present an example which shows that there is a difference between saying that a collection \mathcal{B} of subsets of X is a basis for some topology, and saying that it is a basis for a given topology.

2.3.1 Example. Let \mathcal{B} be the collection of all half-open intervals of the form $(a, b]$, $a < b$, where $(a, b] = \{x : x \in \mathbb{R}, a < x \leq b\}$. Then \mathcal{B} is a basis for a topology on \mathbb{R} , since \mathbb{R} is the union of all members of \mathcal{B} and the intersection of any two half-open intervals is a half-open interval.

However, the topology \mathcal{T}_1 which has \mathcal{B} as its basis, is not the euclidean topology on \mathbb{R} . We can see this by observing that $(a, b]$ is an open set in \mathbb{R} with topology \mathcal{T}_1 , while $(a, b]$ is not an open set in \mathbb{R} with the euclidean topology. (See [Exercises 2.1 #1](#).) So \mathcal{B} is a basis for some topology but not a basis for the euclidean topology on \mathbb{R} . □

2.3.2 Proposition. Let (X, \mathcal{T}) be a topological space. A family \mathcal{B} of open subsets of X is a basis for \mathcal{T} if and only if for any point x belonging to any open set U , there is a $B \in \mathcal{B}$ such that $x \in B \subseteq U$.

Proof.

We are required to prove that

(i) if \mathcal{B} is a basis for \mathcal{T} and $x \in U \in \mathcal{T}$, then there exists a $B \in \mathcal{B}$ such that $x \in B \subseteq U$,

and

(ii) if for each $U \in \mathcal{T}$ and $x \in U$ there exists a $B \in \mathcal{B}$ such that $x \in B \subseteq U$, then \mathcal{B} is a basis for \mathcal{T} .

Assume \mathcal{B} is a basis for \mathcal{T} and $x \in U \in \mathcal{T}$. As \mathcal{B} is a basis for \mathcal{T} , the open set U is a union of members of \mathcal{B} ; that is, $U = \bigcup_{j \in J} B_j$, where $B_j \in \mathcal{B}$, for each j in some index set J . But $x \in U$ implies $x \in B_j$, for some $j \in J$. Thus $x \in B_j \subseteq U$, as required.

Conversely, assume that for each $U \in \mathcal{T}$ and each $x \in U$, there exists a $B \in \mathcal{B}$ with $x \in B \subseteq U$. We have to show that every open set is a union of members of \mathcal{B} . So let V be any open set. Then for each $x \in V$, there is a $B_x \in \mathcal{B}$ such that $x \in B_x \subseteq V$. Clearly $V = \bigcup_{x \in V} B_x$. (Check this!) Thus V is a union of members of \mathcal{B} . \square

2.3.3 Proposition. Let \mathcal{B} be a basis for a topology \mathcal{T} on a set X . Then a subset U of X is open if and only if for each $x \in U$ there exists a $B \in \mathcal{B}$ such that $x \in B \subseteq U$.

Proof. Let U be any subset of X . Assume that for each $x \in U$, there exists a $B_x \in \mathcal{B}$ such that $x \in B_x \subseteq U$. Clearly $U = \bigcup_{x \in U} B_x$. So U is a union of open sets and hence is open, as required. The converse statement follows from [Proposition 2.3.2](#). \square

Observe that the basis property described in [Proposition 2.3.3](#) is precisely what we used in [defining](#) the euclidean topology on \mathbb{R} . We said that a subset U of \mathbb{R} is open if and only if for each $x \in U$, there exist a and b in \mathbb{R} with $a < b$, such that $x \in (a, b) \subseteq U$.

Warning. Make sure that you understand the difference between [Proposition 2.2.8](#) and [Proposition 2.3.2](#). [Proposition 2.2.8](#) gives conditions for a family \mathcal{B} of subsets of a set X to be a basis for some topology on X . However, [Proposition 2.3.2](#) gives conditions for a family \mathcal{B} of subsets of a topological space (X, \mathcal{T}) to be a basis for the given topology \mathcal{T} .

We have seen that a topology can have many different bases. The next proposition tells us when two bases \mathcal{B}_1 and \mathcal{B}_2 on the set X define the same topology.

2.3.4 Proposition. Let \mathcal{B}_1 and \mathcal{B}_2 be bases for topologies \mathcal{T}_1 and \mathcal{T}_2 , respectively, on a non-empty set X . Then $\mathcal{T}_1 = \mathcal{T}_2$ if and only if

- (i) for each $B \in \mathcal{B}_1$ and each $x \in B$, there exists a $B' \in \mathcal{B}_2$ such that $x \in B' \subseteq B$, and
- (ii) for each $B \in \mathcal{B}_2$ and each $x \in B$, there exists a $B' \in \mathcal{B}_1$ such that $x \in B' \subseteq B$.

Proof.

We are required to show that \mathcal{B}_1 and \mathcal{B}_2 are bases for the same topology if and only if (i) and (ii) are true.

Firstly we assume that they are bases for the same topology, that is $\mathcal{T}_1 = \mathcal{T}_2$, and show that conditions (i) and (ii) hold.

Next we assume that (i) and (ii) hold and show that $\mathcal{T}_1 = \mathcal{T}_2$.

Firstly, assume that $\mathcal{T}_1 = \mathcal{T}_2$. Then (i) and (ii) are immediate consequences of [Proposition 2.3.2](#).

Conversely, assume that \mathcal{B}_1 and \mathcal{B}_2 satisfy the conditions (i) and (ii). By [Proposition 2.3.2](#), (i) implies that each $B \in \mathcal{B}_1$ is open in (X, \mathcal{T}_2) ; that is, $\mathcal{B}_1 \subseteq \mathcal{T}_2$. As every member of \mathcal{T}_1 is a union of members of \mathcal{T}_2 this implies $\mathcal{T}_1 \subseteq \mathcal{T}_2$. Similarly (ii) implies $\mathcal{T}_2 \subseteq \mathcal{T}_1$. Hence $\mathcal{T}_1 = \mathcal{T}_2$, as required. \square

2.3.5 Example. Show that the set \mathcal{B} of all “open equilateral triangles” with base parallel to the X-axis is a basis for the euclidean topology on \mathbb{R}^2 . (By an “open triangle” we mean that the boundary is not included.)

Outline Proof. (We give here only a pictorial argument. It is left to you to write a detailed proof.)

We are required to show that \mathcal{B} is a basis for the euclidean topology.

We shall apply [Proposition 2.3.4](#), but first we need to show that \mathcal{B} is a basis for some topology on \mathbb{R}^2 .

To do this we show that \mathcal{B} satisfies the conditions of [Proposition 2.2.8](#).

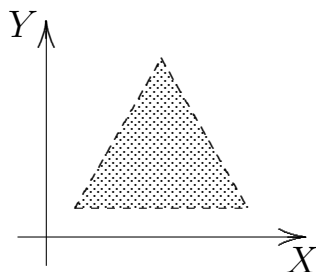

The first thing we observe is that \mathcal{B} is a basis for some topology because it satisfies the conditions of [Proposition 2.2.8](#). (To see that \mathcal{B} satisfies [Proposition 2.2.8](#), observe that \mathbb{R}^2 equals the union of all open equilateral triangles with base parallel to the X-axis, and that the intersection of two such triangles is another such triangle.)

Next we shall show that the conditions (i) and (ii) of [Proposition 2.3.4](#) are satisfied.

Firstly we verify condition (i). Let R be an open rectangle with sides parallel to the axes and any x any point in R . We have to show that there is an open equilateral triangle T with base parallel to the X-axis such that $x \in T \subseteq R$. Pictorially this is easy to see.

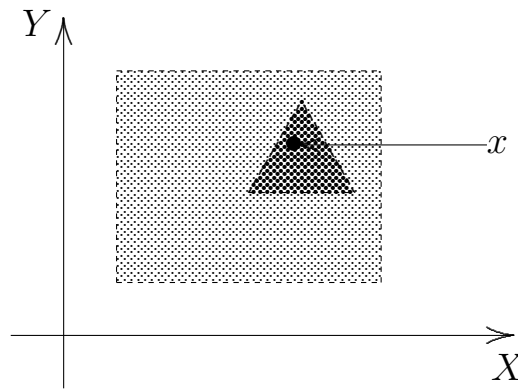

Finally we verify condition (ii) of [Proposition 2.3.4](#). Let T' be an open equilateral triangle with base parallel to the X -axis and let y be any point in T' . Then there exists an open rectangle R' such that $y \in R' \subseteq T'$. Pictorially, this is again easy to see.

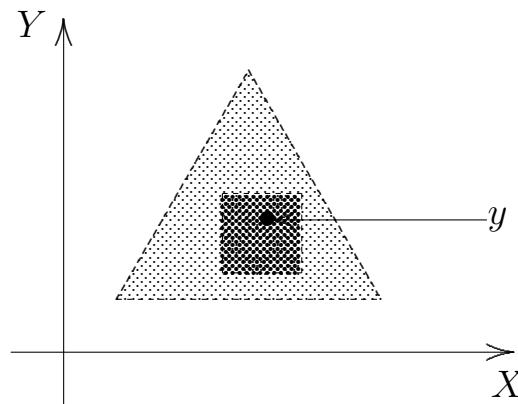

So the conditions of [Proposition 2.3.4](#) are satisfied. Thus \mathcal{B} is indeed a basis for the euclidean topology on \mathbb{R}^2 . □

In [Example 2.2.9](#) we defined a basis for the euclidean topology to be the collection of all “open rectangles” (with sides parallel to the axes). [Example 2.3.5](#) shows that “open rectangles” can be replaced by “open equilateral triangles” (with base parallel to the X -axis) without changing the topology. In [Exercises 2.3 #1](#) we see that the conditions above in brackets can be dropped without changing the topology. Also “open rectangles” can be replaced by “open discs”².

²In fact, most books describe the euclidean topology on \mathbb{R}^2 in terms of open discs.

Exercises 2.3

1. Determine whether or not each of the following collections is a basis for the euclidean topology on \mathbb{R}^2 :
 - (i) the collection of all “open” squares with sides parallel to the axes;
 - (ii) the collection of all “open” discs;
 - (iii) the collection of all “open” squares;
 - (iv) the collection of all “open” rectangles;
 - (v) the collection of all “open” triangles.

2. (i) Let \mathcal{B} be a basis for a topology \mathcal{T} on a non-empty set X . If \mathcal{B}_1 is a collection of subsets of X such that $\mathcal{T} \supseteq \mathcal{B}_1 \supseteq \mathcal{B}$, prove that \mathcal{B}_1 is also a basis for \mathcal{T} .

(ii) Deduce from (i) that there exist an uncountable number of distinct bases for the euclidean topology on \mathbb{R} .

3. Let $\mathcal{B} = \{(a, b) : a, b \in \mathbb{R}, a < b\}$. As seen in [Example 2.3.1](#), \mathcal{B} is a basis for a topology \mathcal{T} on \mathbb{R} and \mathcal{T} is not the euclidean topology on \mathbb{R} . Nevertheless, show that each interval (a, b) is open in $(\mathbb{R}, \mathcal{T})$.

- 4.* Let $C[0, 1]$ be the set of all continuous real-valued functions on $[0, 1]$.
 - (i) Show that the collection \mathcal{M} , where $\mathcal{M} = \{M(f, \varepsilon) : f \in C[0, 1] \text{ and } \varepsilon \text{ is a positive real number}\}$ and $M(f, \varepsilon) = \left\{g : g \in C[0, 1] \text{ and } \int_0^1 |f - g| < \varepsilon\right\}$, is a basis for a topology \mathcal{T}_1 on $C[0, 1]$.
 - (ii) Show that the collection \mathcal{U} , where $\mathcal{U} = \{U(f, \varepsilon) : f \in C[0, 1] \text{ and } \varepsilon \text{ is a positive real number}\}$ and $U(f, \varepsilon) = \{g : g \in C[0, 1] \text{ and } \sup_{x \in [0, 1]} |f(x) - g(x)| < \varepsilon\}$, is a basis for a topology \mathcal{T}_2 on $C[0, 1]$.
 - (iii) Prove that $\mathcal{T}_1 \neq \mathcal{T}_2$.

Subbasis for a Topology

5. Let (X, \mathcal{T}) be a topological space. A non-empty collection \mathcal{S} of open subsets of X is said to be a **subbasis** for \mathcal{T} if the collection of all finite intersections of members of \mathcal{S} forms a basis for \mathcal{T} .
 - (i) Prove that the collection of all open intervals of the form (a, ∞) or $(-\infty, b)$ is a subbasis for the euclidean topology on \mathbb{R} .
 - (ii) Prove that $\mathcal{S} = \{\{a\}, \{a, c, d\}, \{b, c, d, e, f\}\}$ is a subbasis for the topology \mathcal{T}_1 of [Example 1.1.2](#).
6. Let \mathcal{S} be a subbasis for a topology \mathcal{T} on the set \mathbb{R} . (See [Exercise 5 above](#).) If all of the closed intervals $[a, b]$, with $a < b$, are in \mathcal{S} , prove that \mathcal{T} is the discrete topology.
7. Let X be a set with at least two elements and \mathcal{S} the collection of all sets $X \setminus \{x\}$, $x \in X$. Prove \mathcal{S} is a subbasis for the finite-closed topology on X .
8. Let X be any infinite set and \mathcal{T} the discrete topology on X . Find a subbasis \mathcal{S} for \mathcal{T} such that \mathcal{S} does not contain any singleton sets.
9. Let \mathcal{S} be the collection of all straight lines in the plane \mathbb{R}^2 . If \mathcal{S} is a subbasis for a topology \mathcal{T} on the set \mathbb{R}^2 , what is the topology?
10. Let \mathcal{S} be the collection of all straight lines in the plane which are parallel to the X-axis. If \mathcal{S} is a subbasis for a topology \mathcal{T} on \mathbb{R}^2 , describe the open sets in $(\mathbb{R}^2, \mathcal{T})$.
11. Let \mathcal{S} be the collection of all circles in the plane. If \mathcal{S} is a subbasis for a topology \mathcal{T} on \mathbb{R}^2 , describe the open sets in $(\mathbb{R}^2, \mathcal{T})$.
12. Let \mathcal{S} be the collection of all circles in the plane which have their centres on the X-axis. If \mathcal{S} is a subbasis for a topology \mathcal{T} on \mathbb{R}^2 , describe the open sets in $(\mathbb{R}^2, \mathcal{T})$.

2.4 Postscript

In this chapter we have defined a very important topological space – \mathbb{R} , the set of all real numbers with the euclidean topology, and spent some time analyzing it. We observed that, in this topology, open intervals are indeed open sets (and closed intervals are closed sets). However, not all open sets are open intervals. Nevertheless, every open set in \mathbb{R} is a union of open intervals. This led us to introduce the notion of “basis for a topology” and to establish that the collection of all open intervals is a basis for the euclidean topology on \mathbb{R} .

In the introduction to [Chapter 1](#) we described a mathematical proof as a watertight argument and underlined the importance of writing proofs. In this chapter we were introduced to proof by contradiction in [Remarks 2.1.2 \(v\)](#) with another example in [Example 2.2.7](#). Proving “necessary and sufficient” conditions, that is, “if and only if” conditions, was explained in [Proposition 2.2.1](#), with further examples in [Propositions 2.2.8, 2.3.2, 2.3.3, and 2.3.4](#).

Bases for topologies is a significant topic in its own right. We saw, for example, that the collection of all singletons is a basis for the discrete topology. [Proposition 2.2.8](#) gives necessary and sufficient conditions for a collection of subsets of a set X to be a basis for [some](#) topology on X . This was contrasted with [Proposition 2.3.2](#) which gives necessary and sufficient conditions for a collection of subsets of X to be a basis for the [given](#) topology on X . It was noted that two different collections \mathcal{B}_1 and \mathcal{B}_2 can be bases for the same topology. Necessary and sufficient conditions for this are given by [Proposition 2.3.4](#).

We defined the euclidean topology on \mathbb{R}^n , for n any positive integer. We saw that the family of all open discs is a basis for \mathbb{R}^2 , as is the family of all open squares, or the family of all open rectangles.

The exercises introduced three interesting ideas. [Exercises 2.1 #8](#) covered the notions of F_σ -set and G_δ -set which are important in measure theory. [Exercises 2.3 #4](#) introduced the space of continuous real-valued functions. Such spaces are called function spaces which are the central objects of study in functional analysis. Functional analysis is a blend of (classical) analysis and topology, and was for some time called modern analysis, cf. Simmons [362]. Finally, [Exercises 2.3 #5–12](#) dealt with the notion of subbasis.

By now you should have watched the videos:

Topology Without Tears - Video 1 - Pure Mathematics

Topology Without Tears - Video 2a & 2b - Infinite Set Theory

Topology Without Tears - Video 4a & 4b & 4c & 4d - Writing Proofs in Mathematics

Links to these videos on YouTube and Youku can be found on

<http://www.topologywithouttears.net>.

Chapter 3

Limit Points

Introduction

On the real number line we have a notion of “closeness”. For example each point in the sequence $.1, .01, .001, .0001, .00001, \dots$ is closer to 0 than the previous one. Indeed, in some sense, 0 is a limit point of this sequence. So the interval $(0, 1]$ is not closed, as it does not contain the limit point 0. In a general topological space we do not have a “distance function”, so we must proceed differently. We shall define the notion of limit point without resorting to distances. Even with our new definition of limit point, the point 0 will still be a limit point of $(0, 1]$. The introduction of the notion of limit point will lead us to a much better understanding of the notion of closed set.

Another very important topological concept we shall introduce in this chapter is that of connectedness. Consider the topological space \mathbb{R} . While the sets $[0, 1] \cup [2, 3]$ and $[4, 6]$ could both be described as having length 2, it is clear that they are different types of sets ... the first consists of two disjoint pieces and the second of just one piece. The difference between the two is “topological” and will be exposed using the notion of connectedness.

In order to understand this chapter, you should familiarize yourself with the content of [Appendix 1](#).

As mentioned previously, this is supplemented by the videos "Topology Without Tears - Video 2a & 2b - Infinite Set Theory" which are on YouTube at

<http://youtu.be/9h83ZJeiec> &

<http://youtu.be/QPSRB4Fhzko>;

on Youku at <http://tinyurl.com/m4dlzhh> &

<http://tinyurl.com/kf9lp8e>;

and have links from

<http://www.topologywithouttears.net>.

3.1 Limit Points and Closure

If (X, \mathcal{T}) is a topological space then it is usual to refer to the elements of the set X as **points**.

3.1.1 Definition. Let A be a subset of a topological space (X, \mathcal{T}) . A point $x \in X$ is said to be a **limit point** (or **accumulation point** or **cluster point**) of A if every open set, U , containing x contains a point of A different from x .

3.1.2 Example. Consider the topological space (X, \mathcal{T}) where the set $X = \{a, b, c, d, e\}$, the topology $\mathcal{T} = \{X, \emptyset, \{a\}, \{c, d\}, \{a, c, d\}, \{b, c, d, e\}\}$, and $A = \{a, b, c\}$. Then b , d , and e are limit points of A but a and c are not limit points of A .

Proof.

The point a is a limit point of A if and only if every open set containing a contains another point of the set A .

So to show that a is **not** a limit point of A , it suffices to find even one open set which contains a but contains no other point of A .

The set $\{a\}$ is open and contains no other point of A . So a is not a limit point of A .

The set $\{c, d\}$ is an open set containing c but no other point of A . So c is not a limit point of A .

To show that b is a limit point of A , we have to show that every open set containing b contains a point of A other than b .

We shall show this is the case by writing down **all** of the open sets containing b and verifying that each contains a point of A other than b .

The only open sets containing b are X and $\{b, c, d, e\}$ and both contain another element of A , namely c . So b is a limit point of A .

The point d is a limit point of A , even though it is not in A . This is so since every open set containing d contains a point of A . Similarly e is a limit point of A even though it is not in A . □

3.1.3 Example. Let (X, \mathcal{T}) be a discrete space and A a subset of X . Then A has no limit points, since for each $x \in X$, $\{x\}$ is an open set containing no point of A different from x . \square

3.1.4 Example. Consider the subset $A = [a, b)$ of \mathbb{R} . Then it is easily verified that every element in $[a, b)$ is a limit point of A . The point b is also a limit point of A . \square

3.1.5 Example. Let (X, \mathcal{T}) be an indiscrete space and A a subset of X with at least two elements. Then it is readily seen that every point of X is a limit point of A . (Why did we insist that A have at least two points?) \square

The next proposition provides a useful way of testing whether a set is closed or not.

3.1.6 Proposition. Let A be a subset of a topological space (X, \mathcal{T}) . Then A is closed in (X, \mathcal{T}) if and only if A contains all of its limit points.

Proof.

We are required to prove that A is closed in (X, \mathcal{T}) if and only if A contains all of its limit points; that is, we have to show that

- (i) if A is a closed set, then it contains all of its limit points, and
- (ii) if A contains all of its limit points, then it is a closed set.

Assume that A is closed in (X, \mathcal{T}) . Suppose that p is a limit point of A which belongs to $X \setminus A$. Then $X \setminus A$ is an open set containing the limit point p of A . Therefore $X \setminus A$ contains an element of A . This is clearly false and so we have a contradiction to our supposition. Therefore every limit point of A must belong to A .

Conversely, assume that A contains all of its limit points. For each $z \in X \setminus A$, our assumption implies that there exists an open set $U_z \ni z$ such that $U_z \cap A = \emptyset$; that is, $U_z \subseteq X \setminus A$. Therefore $X \setminus A = \bigcup_{z \in X \setminus A} U_z$. (Check this!) So $X \setminus A$ is a union of open sets and hence is open. Consequently its complement, A , is closed. \square

3.1.7 Example. As applications of [Proposition 3.1.6](#) we have the following:

- (i) the set $[a, b)$ is not closed in \mathbb{R} , since b is a limit point and $b \notin [a, b)$;
- (ii) the set $[a, b]$ is closed in \mathbb{R} , since all the limit points of $[a, b]$ (namely all the elements of $[a, b)$) are in $[a, b]$;
- (iii) (a, b) is not a closed subset of \mathbb{R} , since it does not contain the limit point a ;
- (iv) $[a, \infty)$ is a closed subset of \mathbb{R} . \square

3.1.8 Proposition. Let A be a subset of a topological space (X, \mathcal{T}) and A' the set of all limit points of A . Then $A \cup A'$ is a closed set.

Proof. From [Proposition 3.1.6](#) it suffices to show that the set $A \cup A'$ contains all of [its](#) limit points or equivalently that no element of $X \setminus (A \cup A')$ is a limit point of $A \cup A'$.

Let $p \in X \setminus (A \cup A')$. As $p \notin A'$, there exists an open set U containing p with $U \cap A = \{p\}$ or \emptyset . But $p \notin A$, so $U \cap A = \emptyset$. We claim also that $U \cap A' = \emptyset$. For if $x \in U$ then as U is an open set and $U \cap A = \emptyset$, $x \notin A'$. Thus $U \cap A' = \emptyset$. That is, $U \cap (A \cup A') = \emptyset$, and $p \in U$. This implies p is not a limit point of $A \cup A'$ and so $A \cup A'$ is a closed set. \square

3.1.9 Definition. Let A be a subset of a topological space (X, \mathcal{T}) . Then the set $A \cup A'$ consisting of A and all its limit points is called the **closure of A** and is denoted by \overline{A} .

3.1.10 Remark. It is clear from [Proposition 3.1.8](#) that \overline{A} is a closed set. By [Proposition 3.1.6](#) and [Exercises 3.1 #5 \(i\)](#), every closed set containing A must also contain the set A' . So $A \cup A' = \overline{A}$ is the smallest closed set containing A . This implies that \overline{A} is the intersection of all closed sets containing A . \square

3.1.11 Example. Let $X = \{a, b, c, d, e\}$ and

$$\mathcal{T} = \{X, \emptyset, \{a\}, \{c, d\}, \{a, c, d\}, \{b, c, d, e\}\}.$$

Show that $\overline{\{b\}} = \{b, e\}$, $\overline{\{a, c\}} = X$, and $\overline{\{b, d\}} = \{b, c, d, e\}$.

Proof.

To find the closure of a particular set, we shall find all the closed sets containing that set and then select the smallest. We therefore begin by writing down all of the closed sets – these are simply the complements of all the open sets.

The closed sets are $\emptyset, X, \{b, c, d, e\}, \{a, b, e\}, \{b, e\}$ and $\{a\}$. So the smallest closed set containing $\{b\}$ is $\{b, e\}$; that is, $\overline{\{b\}} = \{b, e\}$. Similarly $\overline{\{a, c\}} = X$, and $\overline{\{b, d\}} = \{b, c, d, e\}$. \square

3.1.12 Example. Let \mathbb{Q} be the subset of \mathbb{R} consisting of all the rational numbers. Prove that $\overline{\mathbb{Q}} = \mathbb{R}$.

Proof. Suppose $\overline{\mathbb{Q}} \neq \mathbb{R}$. Then there exists an $x \in \mathbb{R} \setminus \overline{\mathbb{Q}}$. As $\mathbb{R} \setminus \overline{\mathbb{Q}}$ is open in \mathbb{R} , there exist a, b with $a < b$ such that $x \in (a, b) \subseteq \mathbb{R} \setminus \overline{\mathbb{Q}}$. But in every interval (a, b) there is a rational number q ; that is, $q \in (a, b)$. So $q \in \mathbb{R} \setminus \overline{\mathbb{Q}}$ which implies $q \in \mathbb{R} \setminus \mathbb{Q}$. This is a contradiction, as $q \in \mathbb{Q}$. Hence $\overline{\mathbb{Q}} = \mathbb{R}$. \square

3.1.13 Definition. Let A be a subset of a topological space (X, \mathcal{T}) . Then A is said to be **dense** in X or **everywhere dense** in X if $\overline{A} = X$.

We can now restate [Example 3.1.12](#) as: \mathbb{Q} is a dense subset of \mathbb{R} .

Note that in [Example 3.1.11](#) we saw that $\{a, c\}$ is dense in X .

3.1.14 Example. Let (X, \mathcal{T}) be a discrete space. Then every subset of X is closed (since its complement is open). Therefore the only dense subset of X is X itself, since each subset of X is its own closure. \square

3.1.15 Proposition. Let A be a subset of a topological space (X, \mathcal{T}) . Then A is dense in X if and only if every non-empty open subset of X intersects A non-trivially (that is, if $U \in \mathcal{T}$ and $U \neq \emptyset$ then $A \cap U \neq \emptyset$.)

Proof. Assume, firstly that every non-empty open set intersects A non-trivially. If $A = X$, then clearly A is dense in X . If $A \neq X$, let $x \in X \setminus A$. If $U \in \mathcal{T}$ and $x \in U$ then $U \cap A \neq \emptyset$. So x is a limit point of A . As x is an arbitrary point in $X \setminus A$, every point of $X \setminus A$ is a limit point of A . So $A' \supseteq X \setminus A$ and then, by [Definition 3.1.9](#), $\overline{A} = A' \cup A = X$; that is, A is dense in X .

Conversely, assume A is dense in X . Let U be any non-empty open subset of X . Suppose $U \cap A = \emptyset$. Then if $x \in U$, $x \notin A$ and x is not a limit point of A , since U is an open set containing x which does not contain any element of A . This is a contradiction since, as A is dense in X , every element of $X \setminus A$ is a limit point of A . So our supposition is false and $U \cap A \neq \emptyset$, as required. \square

Exercises 3.1

1. (a) In [Example 1.1.2](#), find all the limit points of the following sets:
 - (i) $\{a\}$,
 - (ii) $\{b, c\}$,
 - (iii) $\{a, c, d\}$,
 - (iv) $\{b, d, e, f\}$.

(b) Hence, find the closure of each of the above sets.

(c) Now find the closure of each of the above sets using the method of [Example 3.1.11](#).
2. Let $(\mathbb{Z}, \mathcal{T})$ be the set of integers with the finite-closed topology. List the set of limit points of the following sets:
 - (i) $A = \{1, 2, 3, \dots, 10\}$,
 - (ii) The set, E , consisting of all even integers.

3. Find all the limit points of the open interval (a, b) in \mathbb{R} , where $a < b$.
4. (a) What is the closure in \mathbb{R} of each of the following sets?
- (i) $\{1, \frac{1}{2}, \frac{1}{3}, \frac{1}{4}, \dots, \frac{1}{n}, \dots\}$;
 - (ii) the set \mathbb{Z} of all integers;
 - (iii) the set \mathbb{P} of all irrational numbers.
- (b) Let S be a non-empty subset of \mathbb{R} and $a \in \mathbb{R}$. Prove that $a \in \overline{S}$ if and only if for each positive integer n , there exists an $x_n \in S$ such that $|x_n - a| < \frac{1}{n}$.
5. Let S and T be non-empty subsets of a topological space (X, \mathcal{T}) with $S \subseteq T$.
- (i) If p is a limit point of the set S , verify that p is also a limit point of the set T .
 - (ii) Deduce from (i) that $\overline{S} \subseteq \overline{T}$.
 - (iii) Hence show that if S is dense in X , then T is dense in X .
 - (iv) Using (iii) show that \mathbb{R} has an uncountable number of distinct dense subsets.
[Hint: Uncountable sets are discussed in [Appendix 1](#).]
 - (v)* Again using (iii), prove that \mathbb{R} has an uncountable number of distinct countable dense subsets and $2^{\mathfrak{c}}$ distinct uncountable dense subsets.
[Hint: Note that \mathfrak{c} is discussed in [Appendix 1](#).]
6. Let A and B be subsets of the space \mathbb{R} with the Euclidean topology. Consider the four sets (i) $A \cap \overline{B}$; (ii) $\overline{A} \cap B$; (iii) $\overline{A} \cap \overline{B}$; (iv) $\overline{A \cap B}$.
- (a) If A is the set of all rational numbers and B is the set of all irrational numbers, prove that no two of the above four sets are equal.
 - (b) If A and B are open intervals in \mathbb{R} , prove that at least two of the above four sets are equal.
 - (c) Find open subsets A and B of \mathbb{R} such that no two of the above four sets are equal.

3.2 Neighbourhoods

3.2.1 Definition. Let (X, \mathcal{T}) be a topological space, N a subset of X and p a point in N . Then N is said to be a **neighbourhood** of the point p if there exists an open set U such that $p \in U \subseteq N$.

3.2.2 Example. The closed interval $[0, 1]$ in \mathbb{R} is a neighbourhood of the point $\frac{1}{2}$, since $\frac{1}{2} \in (\frac{1}{4}, \frac{3}{4}) \subseteq [0, 1]$. \square

3.2.3 Example. The interval $(0, 1]$ in \mathbb{R} is a neighbourhood of the point $\frac{1}{4}$, as $\frac{1}{4} \in (0, \frac{1}{2}) \subseteq (0, 1]$. But $(0, 1]$ is not a neighbourhood of the point 1. (Prove this.) \square

3.2.4 Example. If (X, \mathcal{T}) is any topological space and $U \in \mathcal{T}$, then from [Definition 3.2.1](#), it follows that U is a neighbourhood of every point $p \in U$. So, for example, every open interval (a, b) in \mathbb{R} is a neighbourhood of every point that it contains. \square

3.2.5 Example. Let (X, \mathcal{T}) be a topological space, and N a neighbourhood of a point p . If S is any subset of X such that $N \subseteq S$, then S is a neighbourhood of p . \square

The next proposition is easily verified, so its proof is left to the reader.

3.2.6 Proposition. Let A be a subset of a topological space (X, \mathcal{T}) . A point $x \in X$ is a limit point of A if and only if every neighbourhood of x contains a point of A different from x . \square

As a set is closed if and only if it contains all its limit points we deduce the following:

3.2.7 Corollary. Let A be a subset of a topological space (X, \mathcal{T}) . Then the set A is closed if and only if for each $x \in X \setminus A$ there is a neighbourhood N of x such that $N \subseteq X \setminus A$. □

3.2.8 Corollary. Let U be a subset of a topological space (X, \mathcal{T}) . Then $U \in \mathcal{T}$ if and only if for each $x \in U$ there exists a neighbourhood N of x such that $N \subseteq U$. □

The next corollary is readily deduced from [Corollary 3.2.8](#).

3.2.9 Corollary. Let U be a subset of a topological space (X, \mathcal{T}) . Then $U \in \mathcal{T}$ if and only if for each $x \in U$ there exists a $V \in \mathcal{T}$ such that $x \in V \subseteq U$. □

[Corollary 3.2.9](#) provides a useful test of whether a set is open or not. It says that a set is open if and only if it contains an open set about each of its points.

Exercises 3.2

1. Let A be a subset of a topological space (X, \mathcal{T}) . Prove that A is dense in X if and only if every neighbourhood of each point in $X \setminus A$ intersects A non-trivially.
2. (i) Let A and B be subsets of a topological space (X, \mathcal{T}) . Prove carefully that

$$\overline{A \cap B} \subseteq \overline{A} \cap \overline{B}.$$

- (ii) Construct an example in which

$$\overline{A \cap B} \neq \overline{A} \cap \overline{B}.$$

3. Let (X, \mathcal{T}) be a topological space. Prove that \mathcal{T} is the finite-closed topology on X if and only if (i) (X, \mathcal{T}) is a T_1 -space, and (ii) every infinite subset of X is dense in X .

Separable Spaces

4. A topological space (X, \mathcal{T}) is said to be **separable** if it has a dense subset which is countable. Determine which of the following spaces are separable:
- (i) the set \mathbb{R} with the usual topology;
 - (ii) a countable set with the discrete topology;
 - (iii) a countable set with the finite-closed topology;
 - (iv) (X, \mathcal{T}) where X is finite;
 - (v) (X, \mathcal{T}) where \mathcal{T} is finite;
 - (vi) an uncountable set with the discrete topology;
 - (vii) an uncountable set with the finite-closed topology;
 - (viii) a space (X, \mathcal{T}) satisfying the second axiom of countability.

Interior of a Set

5. Let (X, \mathcal{T}) be any topological space and A any subset of X . The largest open set contained in A is called the **interior of A** and is denoted by **$\text{Int}(A)$** . [It is the union of all open sets in X which lie wholly in A .]
- (i) Prove that in \mathbb{R} , $\text{Int}([0, 1]) = (0, 1)$.
 - (ii) Prove that in \mathbb{R} , $\text{Int}((3, 4)) = (3, 4)$.
 - (iii) Show that if A is open in (X, \mathcal{T}) then $\text{Int}(A) = A$.
 - (iv) Verify that in \mathbb{R} , $\text{Int}(\{3\}) = \emptyset$.
 - (v) Show that if (X, \mathcal{T}) is an indiscrete space then, for all proper subsets A of X , $\text{Int}(A) = \emptyset$.
 - (vi) Show that for every countable subset A of \mathbb{R} , $\text{Int}(A) = \emptyset$.
6. Show that if A is any subset of a topological space (X, \mathcal{T}) , then $\text{Int}(A) = X \setminus \overline{(X \setminus A)}$. (See [Exercise 5 above](#) for the definition of Int .)
7. Using [Exercise 6 above](#), verify that A is dense in (X, \mathcal{T}) if and only if $\text{Int}(X \setminus A) = \emptyset$.

8. Using the definition of Int in [Exercise 5 above](#), determine which of the following statements are true for arbitrary subsets A_1 and A_2 of a topological space (X, \mathcal{T}) ?
- (i) $\text{Int}(A_1 \cap A_2) = \text{Int}(A_1) \cap \text{Int}(A_2)$,
 - (ii) $\text{Int}(A_1 \cup A_2) = \text{Int}(A_1) \cup \text{Int}(A_2)$,
 - (iii) $\overline{A_1 \cup A_2} = \overline{A_1} \cup \overline{A_2}$.
- (If your answer to any part is “true” you must write a proof. If your answer is “false” you must give a concrete counterexample.)
- 9.* Let S be a dense subset of a topological space (X, \mathcal{T}) . Prove that for every open subset U of X , $\overline{S \cap U} = \overline{U}$.
10. Let S and T be dense subsets of a space (X, \mathcal{T}) . If T is also open, deduce from [Exercise 9 above](#) that $S \cap T$ is dense in X .

The Sorgenfrey Line

11. Let $\mathcal{B} = \{[a, b) : a \in \mathbb{R}, b \in \mathbb{Q}, a < b\}$. Prove each of the following statements.
- (i) \mathcal{B} is a basis for a topology \mathcal{T}_1 on \mathbb{R} . (The space $(\mathbb{R}, \mathcal{T}_1)$ is called the **Sorgenfrey line**.)
 - (ii) If \mathcal{T} is the Euclidean topology on \mathbb{R} , then $\mathcal{T}_1 \supset \mathcal{T}$.
 - (iii) For all $a, b \in \mathbb{R}$ with $a < b$, $[a, b)$ is a clopen set in $(\mathbb{R}, \mathcal{T}_1)$.
 - (iv) The Sorgenfrey line is a separable space.
 - (v)* The Sorgenfrey line does not satisfy the second axiom of countability.

3.3 Connectedness

3.3.1 Remark. We record here some definitions and facts you should already know. Let S be any set of real numbers. If there is an element b in S such that $x \leq b$, for all $x \in S$, then b is said to be **the greatest element** of S . Similarly if S contains an element a such that $a \leq x$, for all $x \in S$, then a is called **the least element** of S . A set S of real numbers is said to be **bounded above** if there exists a real number c such that $x \leq c$, for all $x \in S$, and c is called an **upper bound** for S . Similarly the terms “**bounded below**” and “**lower bound**” are defined. A set which is bounded above and bounded below is said to be **bounded**. \square

Least Upper Bound Axiom: Let S be a non-empty set of real numbers. If S is bounded above, then it has a least upper bound. \square

The least upper bound, also called the **supremum** of S , denoted by $\sup(S)$, may or may not belong to the set S . Indeed, the supremum of S is an element of S if and only if S has a greatest element. For example, the supremum of the open interval $S = (1, 2)$ is 2 but $2 \notin (1, 2)$, while the supremum of $[3, 4]$ is 4 which does lie in $[3, 4]$ and 4 is the greatest element of $[3, 4]$. Any set S of real numbers which is bounded below has a **greatest lower bound** which is also called the **infimum** and is denoted by $\inf(S)$.

3.3.2 Lemma. Let S be a subset of \mathbb{R} which is bounded above and let p be the supremum of S . If S is a closed subset of \mathbb{R} , then $p \in S$.

Proof. Suppose $p \in \mathbb{R} \setminus S$. As $\mathbb{R} \setminus S$ is open there exist real numbers a and b with $a < b$ such that $p \in (a, b) \subseteq \mathbb{R} \setminus S$. As p is the least upper bound for S and $a < p$, it is clear that there exists an $x \in S$ such that $a < x$. Also $x < p < b$, and so $x \in (a, b) \subseteq \mathbb{R} \setminus S$. But this is a contradiction, since $x \in S$. Hence our supposition is false and $p \in S$. \square

3.3.3 Proposition. Let T be a clopen subset of \mathbb{R} . Then either $T = \mathbb{R}$ or $T = \emptyset$.

Proof. Suppose $T \neq \mathbb{R}$ and $T \neq \emptyset$. Then there exists an element $x \in T$ and an element $z \in \mathbb{R} \setminus T$. Without loss of generality, assume $x < z$. Put $S = T \cap [x, z]$. Then S , being the intersection of two closed sets, is closed. It is also bounded above, since z is obviously an upper bound. Let p be the supremum of S . By Lemma 3.3.2, $p \in S$. Since $p \in [x, z]$, $p \leq z$. As $z \in \mathbb{R} \setminus S$, $p \neq z$ and so $p < z$.

Now T is also an open set and $p \in T$. So there exist a and b in \mathbb{R} with $a < b$ such that $p \in (a, b) \subseteq T$. Let t be such that $p < t < \min(b, z)$, where $\min(b, z)$ denotes the smaller of b and z . So $t \in T$ and $t \in [p, z]$. Thus $t \in T \cap [x, z] = S$. This is a contradiction since $t > p$ and p is the supremum of S . Hence our supposition is false and consequently $T = \mathbb{R}$ or $T = \emptyset$. \square

3.3.4 Definition. Let (X, \mathcal{T}) be a topological space. Then it is said to be **connected** if the only clopen subsets of X are X and \emptyset .

So restating Proposition 3.3.3 we obtain:

3.3.5 Proposition. The topological space \mathbb{R} is connected. \square

3.3.6 Example. If (X, \mathcal{T}) is any discrete space with more than one element, then (X, \mathcal{T}) is not connected as each singleton set is clopen. \square

3.3.7 Example. If (X, \mathcal{T}) is any indiscrete space, then it is connected as the only clopen sets are X and \emptyset . (Indeed the only open sets are X and \emptyset .) \square

3.3.8 Example. If $X = \{a, b, c, d, e\}$ and

$$\mathcal{T} = \{X, \emptyset, \{a\}, \{c, d\}, \{a, c, d\}, \{b, c, d, e\}\},$$

then (X, \mathcal{T}) is not connected as $\{b, c, d, e\}$ is a clopen subset. \square

3.3.9 Remark. From [Definition 3.3.4](#) it follows that a topological space (X, \mathcal{T}) is not connected (that is, it is **disconnected**) if and only if there are non-empty open sets A and B such that $A \cap B = \emptyset$ and $A \cup B = X$.¹ (See [Exercises 3.3 #3](#).)

We conclude this section by recording that \mathbb{R}^2 (and indeed, \mathbb{R}^n , for each $n \geq 1$) is a connected space. However the proof is delayed to [Chapter 5](#).

Connectedness is a very important property about which we shall say a lot more.

Exercises 3.3

1. Let S be a set of real numbers and $T = \{x : -x \in S\}$.
 - (a) Prove that the real number a is the infimum of S if and only if $-a$ is the supremum of T .
 - (b) Using (a) and the Least Upper Bound Axiom prove that every non-empty set of real numbers which is bounded below has a greatest lower bound.
2. For each of the following sets S of real numbers find the greatest element and the least upper bound, if they exist.
 - (i) $S = \mathbb{R}$.
 - (ii) $S = \mathbb{Z}$ = the set of all integers.
 - (iii) $S = [9, 10)$.
 - (iv) S = the set of all real numbers of the form $1 - \frac{3}{n^2}$, where n is a positive integer.
 - (v) $S = (-\infty, 3]$.

¹Most books use this property to define connectedness.

3. Let (X, \mathcal{T}) be any topological space. Prove that (X, \mathcal{T}) is not connected if and only if it has proper non-empty disjoint open subsets A and B such that $A \cup B = X$.
4. Is the space (X, \mathcal{T}) of [Example 1.1.2](#) connected?
5. Let (X, \mathcal{T}) be any infinite set with the finite-closed topology. Is (X, \mathcal{T}) connected?
6. Let (X, \mathcal{T}) be an infinite set with the countable-closed topology. Is (X, \mathcal{T}) connected?
7. Which of the topological spaces of [Exercises 1.1 #9](#) are connected?

3.4 Postscript

In this chapter we have introduced the notion of limit point and shown that a set is closed if and only if it contains all its limit points. [Proposition 3.1.8](#) then tells us that any set A has a smallest closed set \overline{A} which contains it. The set \overline{A} is called the closure of A .

A subset A of a topological space (X, \mathcal{T}) is said to be dense in X if $\overline{A} = X$. We saw that \mathbb{Q} is dense in \mathbb{R} and the set \mathbb{I} of all irrational numbers is also dense in \mathbb{R} . We introduced the notion of neighbourhood of a point and the notion of connected topological space. We proved an important result, namely that \mathbb{R} is connected. We shall have much more to say about connectedness later.

In the exercises we introduced the notion of interior of a set, this concept being complementary to that of closure of a set.

Chapter 4

Homeomorphisms

Introduction

In each branch of mathematics it is essential to recognize when two structures are equivalent. For example two sets are equivalent, as far as set theory is concerned, if there exists a bijective function which maps one set onto the other. Two groups are equivalent, known as isomorphic, if there exists a homomorphism of one to the other which is one-to-one and onto. Two topological spaces are equivalent, known as homeomorphic, if there exists a homeomorphism of one onto the other.

Before studying this chapter you should have studied [Appendix 1](#) and watched the videos:

[“Topology Without Tears - Video 1 - Pure Mathematics”](#)
which is on YouTube at

<http://youtu.be/veSbFJFjbzU>

and on Youku at

<http://tinyurl.com/mulg9fv>

[“Topology Without Tears - Video 2a & 2b - Infinite Set Theory”](#)

which are on YouTube at

<http://youtu.be/9h83ZJeiecg> and <http://youtu.be/QPSRB4Fhzko>

and on Youku at

<http://tinyurl.com/m4dlzh> and <http://tinyurl.com/kf9lp8e>

and [“Topology Without Tears - Video 4a & 4b & 4c & 4d - Writing Proofs in Mathematics”](#)

which are on YouTube.

Links to the videos on YouTube and Youku can be found on <http://www.topologywithouttears.net>.

4.1 Subspaces

4.1.1 Definition. Let Y be a non-empty subset of a topological space (X, \mathcal{T}) . The collection $\mathcal{T}_Y = \{O \cap Y : O \in \mathcal{T}\}$ of subsets of Y is a topology on Y called the **subspace topology** (or the **relative topology** or the **induced topology** or the **topology induced on Y by \mathcal{T}**). The topological space (Y, \mathcal{T}_Y) is said to be a **subspace** of (X, \mathcal{T}) .

Of course you should check¹ that \mathcal{T}_Y is indeed a topology on Y .

4.1.2 Example. Let $X = \{a, b, c, d, e, f\}$,

$$\mathcal{T} = \{X, \emptyset, \{a\}, \{c, d\}, \{a, c, d\}, \{b, c, d, e, f\}\},$$

and $Y = \{b, c, e\}$. Then the subspace topology on Y is

$$\mathcal{T}_Y = \{Y, \emptyset, \{c\}\}. \quad \square$$

4.1.3 Example. Let $X = \{a, b, c, d, e\}$,

$$\mathcal{T} = \{X, \emptyset, \{a\}, \{c, d\}, \{a, c, d\}, \{b, c, d, e\}\},$$

and $Y = \{a, d, e\}$. Then the induced topology on Y is

$$\mathcal{T}_Y = \{Y, \emptyset, \{a\}, \{d\}, \{a, d\}, \{d, e\}\}. \quad \square$$

4.1.4 Example. Let \mathcal{B} be a basis for the topology \mathcal{T} on X and let Y be a non-empty subset of X . Then it is not hard to show that the collection $\mathcal{B}_Y = \{B \cap Y : B \in \mathcal{B}\}$ is a basis for the subspace topology \mathcal{T}_Y on Y . [Exercise: verify this.]

So let us consider the subset $(1, 2)$ of \mathbb{R} . A basis for the induced topology on $(1, 2)$ is the collection $\{(a, b) \cap (1, 2) : a, b \in \mathbb{R}, a < b\}$; that is, $\{(a, b) : a, b \in \mathbb{R}, 1 \leq a < b \leq 2\}$ is a basis for the induced topology on $(1, 2)$. \square

¹As first observed by Bruce Blackadar and Stanislav Jabuka, Blackadar [44], this is not quite as straightforward as one might think: given an infinite number of sets $U_i : U_i \in \mathcal{T}_Y$ one needs to prove that their union is in \mathcal{T}_Y . So for each U_i , one must select an $O_i \in \mathcal{T}$, such that $O_i \cap Y = U_i$. As this selection of O_i is to be made for each $i \in I$, it may involve us in making an infinite number of arbitrary choices which requires use of the [Axiom of Choice](#). However, one can avoid using the Axiom of Choice by selecting instead a special O_i , namely the union of all the open sets in \mathcal{T} whose intersection with Y is U_i .

4.1.5 Example. Consider the subset $[1, 2]$ of \mathbb{R} . A basis for the subspace topology \mathcal{T} on $[1, 2]$ is

$$\{(a, b) \cap [1, 2] : a, b \in \mathbb{R}, a < b\};$$

that is,

$$\{(a, b) : 1 \leq a < b \leq 2\} \cup \{[1, b) : 1 < b \leq 2\} \cup \{(a, 2] : 1 \leq a < 2\} \cup \{[1, 2]\}$$

is a basis for \mathcal{T} .

But here we see some surprising things happening; e.g. $[1, 1\frac{1}{2})$ is certainly not an open set in \mathbb{R} , but $[1, 1\frac{1}{2}) = (0, 1\frac{1}{2}) \cap [1, 2]$, is an open set in the subspace $[1, 2]$.

Also $(1, 2]$ is not open in \mathbb{R} but is open in $[1, 2]$. Even $[1, 2]$ is not open in \mathbb{R} , but is an open set in $[1, 2]$.

So whenever we speak of a set being open we must make perfectly clear in what space or what topology it is an open set. □

4.1.6 Example. Let \mathbb{Z} be the subset of \mathbb{R} consisting of all the integers. Prove that the topology induced on \mathbb{Z} by the euclidean topology on \mathbb{R} is the discrete topology.

Proof.

To prove that the induced topology, $\tau_{\mathbb{Z}}$, on \mathbb{Z} is discrete, it suffices, by Proposition 1.1.9, to show that every singleton set in \mathbb{Z} is open in $\tau_{\mathbb{Z}}$; that is, if $n \in \mathbb{Z}$ then $\{n\} \in \tau_{\mathbb{Z}}$.

Let $n \in \mathbb{Z}$. Then $\{n\} = (n - 1, n + 1) \cap \mathbb{Z}$. But $(n - 1, n + 1)$ is open in \mathbb{R} and therefore $\{n\}$ is open in the induced topology on \mathbb{Z} . Thus every singleton set in \mathbb{Z} is open in the induced topology on \mathbb{Z} . So the induced topology is discrete. □

Notation. Whenever we refer to

\mathbb{Q} = the set of all rational numbers,

\mathbb{Z} = the set of all integers,

\mathbb{N} = the set of all positive integers,

\mathbb{I} = the set of all irrational numbers,

(a, b) , $[a, b]$, $[a, b)$, $(-\infty, a)$, $(-\infty, a]$, (a, ∞) , or $[a, \infty)$

as topological spaces without explicitly saying what the topology is, we mean the topology induced as a subspace of \mathbb{R} . (Sometimes we shall refer to the induced topology on these sets as the “**usual topology**”.)

Exercises 4.1

1. Let $X = \{a, b, c, d, e\}$ and $\mathcal{T} = \{X, \emptyset, \{a\}, \{a, b\}, \{a, c, d\}, \{a, b, c, d\}, \{a, b, e\}\}$. List the members of the induced topologies \mathcal{T}_Y on $Y = \{a, c, e\}$ and \mathcal{T}_Z on $Z = \{b, c, d, e\}$.
2. Describe the topology induced on the set \mathbb{N} of positive integers by the euclidean topology on \mathbb{R} .
3. Write down a basis for the usual topology on each of the following:
 - (i) $[a, b)$, where $a < b$;
 - (ii) $(a, b]$, where $a < b$;
 - (iii) $(-\infty, a]$;
 - (iv) $(-\infty, a)$;
 - (v) (a, ∞) ;
 - (vi) $[a, \infty)$.

[Hint: see [Examples 4.1.4](#) and [4.1.5](#).]
4. Let $A \subseteq B \subseteq X$ and X have the topology \mathcal{T} . Let \mathcal{T}_B be the subspace topology on B . Further let \mathcal{T}_1 be the topology induced on A by \mathcal{T} , and \mathcal{T}_2 be the topology induced on A by \mathcal{T}_B . Prove that $\mathcal{T}_1 = \mathcal{T}_2$. (So **a subspace of a subspace is a subspace.**)
5. Let (Y, \mathcal{T}_Y) be a subspace of a space (X, \mathcal{T}) . Show that a subset Z of Y is closed in (Y, \mathcal{T}_Y) if and only if $Z = A \cap Y$, where A is a closed subset of (X, \mathcal{T}) .

6. Show that every subspace of a discrete space is discrete.
7. Show that every subspace of an indiscrete space is indiscrete.
8. Show that the subspace $[0, 1] \cup [3, 4]$ of \mathbb{R} has at least 4 clopen subsets. Exactly how many clopen subsets does it have?
9. Is it true that every subspace of a connected space is connected?
10. Let (Y, \mathcal{T}_Y) be a subspace of (X, \mathcal{T}) . Show that $\mathcal{T}_Y \subseteq \mathcal{T}$ if and only if $Y \in \mathcal{T}$.
[Hint: Remember $Y \in \mathcal{T}_Y$.]
11. Let A and B be connected subspaces of a topological space (X, \mathcal{T}) . If $A \cap B \neq \emptyset$, prove that the subspace $A \cup B$ is connected.
12. Let (Y, \mathcal{T}_1) be a subspace of a T_1 -space (X, \mathcal{T}) . Show that (Y, \mathcal{T}_1) is also a T_1 -space.

Hausdorff Spaces or T_2 -spaces

13. A topological space (X, \mathcal{T}) is said to be **Hausdorff** (or a **T_2 -space**) if given any pair of distinct points a, b in X there exist open sets U and V such that $a \in U$, $b \in V$, and $U \cap V = \emptyset$.
 - (i) Show that \mathbb{R} is Hausdorff.
 - (ii) Prove that every discrete space is Hausdorff.
 - (iii) Show that any T_2 -space is also a T_1 -space.
 - (iv) Show that \mathbb{Z} with the finite-closed topology is a T_1 -space but is not a T_2 -space.
 - (v) Prove that any subspace of a T_2 -space is a T_2 -space.
 - (vi) If (X, \mathcal{T}) is a Hausdorff door space (see [Exercises 1.3 #9](#)), prove that at most one point $x \in X$ is a limit point of X and that if a point $y \in X$ is not a limit point of X , then the singleton set $\{y\}$ is an open set.
14. Let (Y, \mathcal{T}_1) be a subspace of a topological space (X, \mathcal{T}) . If (X, \mathcal{T}) satisfies the second axiom of countability, show that (Y, \mathcal{T}_1) also satisfies the second axiom of countability.
15. Let a and b be in \mathbb{R} with $a < b$. Prove that $[a, b]$ is connected.
[Hint: In the statement and proof of [Proposition 3.3.3](#) replace \mathbb{R} everywhere by $[a, b]$.]

16. Let \mathbb{Q} be the set of all rational numbers with the usual topology and let \mathbb{I} be the set of all irrational numbers with the usual topology.
- (i) Prove that neither \mathbb{Q} nor \mathbb{I} is a discrete space.
 - (ii) Is \mathbb{Q} or \mathbb{I} a connected space?
 - (iii) Is \mathbb{Q} or \mathbb{I} a Hausdorff space?
 - (iv) Does \mathbb{Q} or \mathbb{I} have the finite-closed topology?

Regular Spaces and T_3 -Spaces

17. A topological space (X, \mathcal{T}) is said to be a **regular space** if for any closed subset A of X and any point $x \in X \setminus A$, there exist open sets U and V such that $x \in U$, $A \subseteq V$, and $U \cap V = \emptyset$. If (X, \mathcal{T}) is regular and a T_1 -space, then it is said to be a **T_3 -space**. Prove the following statements.
- (i) Every subspace of a regular space is a regular space.
 - (ii) The spaces \mathbb{R} , \mathbb{Z} , \mathbb{Q} , \mathbb{I} , and \mathbb{R}^2 are regular spaces.
 - (iii) If (X, \mathcal{T}) is a regular T_1 -space, then it is a T_2 -space.
 - (iv) The Sorgenfrey line is a regular space.
 - (v)* Let X be the set, \mathbb{R} , of all real numbers and $S = \{\frac{1}{n} : n \in \mathbb{N}\}$. Define a set $C \subseteq \mathbb{R}$ to be closed if $C = A \cup T$, where A is closed in the euclidean topology on \mathbb{R} and T is any subset of S . The complements of these closed sets form a topology \mathcal{T} on \mathbb{R} which is Hausdorff but not regular.

4.2 Homeomorphisms

We now turn to the notion of equivalent topological spaces. We begin by considering an example:

$$X = \{a, b, c, d, e\}, \quad Y = \{g, h, i, j, k\},$$

$$\mathcal{T} = \{X, \emptyset, \{a\}, \{c, d\}, \{a, c, d\}, \{b, c, d, e\}\},$$

and

$$\mathcal{T}_1 = \{Y, \emptyset, \{g\}, \{i, j\}, \{g, i, j\}, \{h, i, j, k\}\}.$$

It is clear that in an intuitive sense (X, \mathcal{T}) is “equivalent” to (Y, \mathcal{T}_1) . The function $f: X \rightarrow Y$ defined by $f(a) = g$, $f(b) = h$, $f(c) = i$, $f(d) = j$, and $f(e) = k$, provides the equivalence. We now formalize this.

4.2.1 Definition. Let (X, \mathcal{T}) and (Y, \mathcal{T}_1) be topological spaces. Then they are said to be **homeomorphic** if there exists a function $f: X \rightarrow Y$ which has the following properties:

- (i) f is one-to-one (that is $f(x_1) = f(x_2)$ implies $x_1 = x_2$),
- (ii) f is onto (that is, for any $y \in Y$ there exists an $x \in X$ such that $f(x) = y$),
- (iii) for each $U \in \mathcal{T}_1$, $f^{-1}(U) \in \mathcal{T}$, and
- (iv) for each $V \in \mathcal{T}$, $f(V) \in \mathcal{T}_1$.

Further, the map f is said to be a **homeomorphism** between (X, \mathcal{T}) and (Y, \mathcal{T}_1) . We write $(X, \mathcal{T}) \cong (Y, \mathcal{T}_1)$. □

We shall show that “ \cong ” is an equivalence relation and use this to show that all open intervals (a, b) are homeomorphic to each other. [Example 4.2.2](#) is the first step, as it shows that “ \cong ” is a transitive relation.

4.2.2 Example. Let $(X, \mathcal{T}), (Y, \mathcal{T}_1)$ and (Z, \mathcal{T}_2) be topological spaces. If $(X, \mathcal{T}) \cong (Y, \mathcal{T}_1)$ and $(Y, \mathcal{T}_1) \cong (Z, \mathcal{T}_2)$, prove that $(X, \mathcal{T}) \cong (Z, \mathcal{T}_2)$.

Proof.

We are given that $(X, \tau) \cong (Y, \tau_1)$; that is, there exists a homeomorphism $f : (X, \tau) \rightarrow (Y, \tau_1)$. We are also given that $(Y, \tau_1) \cong (Z, \tau_2)$; that is, there exists a homeomorphism $g : (Y, \tau_1) \rightarrow (Z, \tau_2)$.

We are required to prove that $(X, \tau) \cong (Z, \tau_2)$; that is, we need to find a homeomorphism $h : (X, \tau) \rightarrow (Z, \tau_2)$. We will prove that the composite map $g \circ f : X \rightarrow Z$ is the required homeomorphism.

As $(X, \mathcal{T}) \cong (Y, \mathcal{T}_1)$ and $(Y, \mathcal{T}_1) \cong (Z, \mathcal{T}_2)$, there exist homeomorphisms $f : (X, \mathcal{T}) \rightarrow (Y, \mathcal{T}_1)$ and $g : (Y, \mathcal{T}_1) \rightarrow (Z, \mathcal{T}_2)$. Consider the composite map $g \circ f : X \rightarrow Z$. [Thus $g \circ f(x) = g(f(x))$, for all $x \in X$.] It is a routine task to verify that $g \circ f$ is one-to-one and onto. Now let $U \in \mathcal{T}_2$. Then, as g is a homeomorphism $g^{-1}(U) \in \mathcal{T}_1$. Using the fact that f is a homeomorphism we obtain that $f^{-1}(g^{-1}(U)) \in \mathcal{T}$. But $f^{-1}(g^{-1}(U)) = (g \circ f)^{-1}(U)$. So $g \circ f$ has property (iii) of [Definition 4.2.1](#). Next let $V \in \mathcal{T}$. Then $f(V) \in \mathcal{T}_1$ and so $g(f(V)) \in \mathcal{T}_2$; that is $g \circ f(V) \in \mathcal{T}_2$ and we see that $g \circ f$ has property (iv) of [Definition 4.2.1](#). Hence $g \circ f$ is a homeomorphism. \square

4.2.3 Remark. [Example 4.2.2](#) shows that “ \cong ” is a transitive binary relation. Indeed it is easily verified that it is an equivalence relation; that is,

- (i) $(X, \mathcal{T}) \cong (X, \mathcal{T})$ (Reflexive);
- (ii) $(X, \mathcal{T}) \cong (Y, \mathcal{T}_1)$ implies $(Y, \mathcal{T}_1) \cong (X, \mathcal{T})$ (Symmetric);

[Observe that if $f : (X, \mathcal{T}) \rightarrow (Y, \mathcal{T}_1)$ is a homeomorphism, then its inverse $f^{-1} : (Y, \mathcal{T}_1) \rightarrow (X, \mathcal{T})$ is also a homeomorphism.]

- (iii) $(X, \mathcal{T}) \cong (Y, \mathcal{T}_1)$ and $(Y, \mathcal{T}_1) \cong (Z, \mathcal{T}_2)$ implies $(X, \mathcal{T}) \cong (Z, \mathcal{T}_2)$ (Transitive).

\square

The next three examples show that all open intervals in \mathbb{R} are homeomorphic. Length is certainly not a topological property. In particular, an open interval of finite length, such as $(0, 1)$, is homeomorphic to one of infinite length, such as $(-\infty, 1)$. Indeed all open intervals are homeomorphic to \mathbb{R} .

4.2.4 Example. Prove that every two non-empty open intervals (a, b) and (c, d) are homeomorphic.

Outline Proof.

By [Remark 4.2.3](#) it suffices to show that (a, b) is homeomorphic to $(0, 1)$ and (c, d) is homeomorphic to $(0, 1)$. But as a and b are arbitrary (except that $a < b$), if (a, b) is homeomorphic to $(0, 1)$ then (c, d) is also homeomorphic to $(0, 1)$. To prove that (a, b) is homeomorphic to $(0, 1)$ it suffices to find a homeomorphism $f : (0, 1) \rightarrow (a, b)$.

Let $a, b \in \mathbb{R}$ with $a < b$ and consider the function $f : (0, 1) \rightarrow (a, b)$ given by $f(x) = a(1 - x) + bx$.

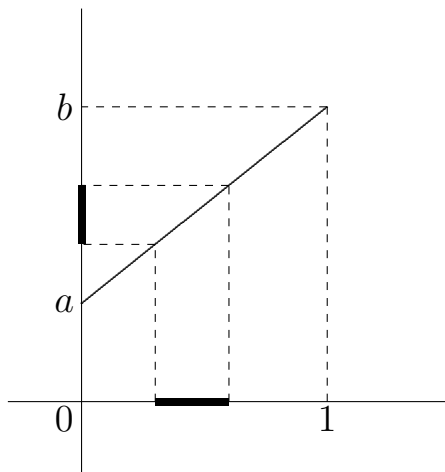

Clearly $f : (0, 1) \rightarrow (a, b)$ is one-to-one and onto. It is also clear from the diagram that the image under f of any open interval in $(0, 1)$ is an open interval in (a, b) ; that is,

$$f(\text{open interval in } (0, 1)) = \text{an open interval in } (a, b).$$

But every open set in $(0, 1)$ is a union of open intervals in $(0, 1)$ and so

$$\begin{aligned} f(\text{open set in } (0, 1)) &= f(\text{union of open intervals in } (0, 1)) \\ &= \text{union of open intervals in } (a, b) \\ &= \text{open set in } (a, b). \end{aligned}$$

So condition (iv) of [Definition 4.2.1](#) is satisfied. Similarly, we see that f^{-1} (open set in (a, b)) is an open set in $(0, 1)$. So condition (iii) of [Definition 4.2.1](#) is also satisfied.

[Exercise: write out the above proof carefully.]

Hence f is a homeomorphism and $(0, 1) \cong (a, b)$, for all $a, b \in \mathbb{R}$ with $a < b$.

From the above it immediately follows that $(a, b) \cong (c, d)$, as required. \square

4.2.5 Example. Prove that the space \mathbb{R} is homeomorphic to the open interval $(-1, 1)$ with the usual topology.

Outline Proof. Define $f : (-1, 1) \rightarrow \mathbb{R}$ by

$$f(x) = \frac{x}{1 - |x|}.$$

It is readily verified that f is one-to-one and onto, and a diagrammatic argument like that in [Example 4.2.2](#) indicates that f is a homeomorphism.

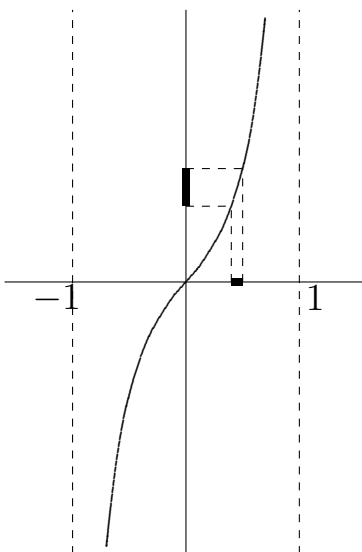

[Exercise: write out a proof that f is a homeomorphism.] \square

4.2.6 Example. Prove that every open interval (a, b) , with $a < b$, is homeomorphic to \mathbb{R} .

Proof. This follows immediately from [Examples 4.2.5](#) and [4.2.4](#) and [Remark 4.2.3](#). \square

4.2.7 Remark. It can be proved in a similar fashion that any two intervals $[a, b]$ and $[c, d]$, with $a < b$ and $c < d$, are homeomorphic. \square

Exercises 4.2

1. (i) If a, b, c , and d are real numbers with $a < b$ and $c < d$, prove that $[a, b] \cong [c, d]$.
 (ii) If a and b are any real numbers, prove that

$$(-\infty, a] \cong (-\infty, b] \cong [a, \infty) \cong [b, \infty).$$

- (iii) If c, d, e , and f are any real numbers with $c < d$ and $e < f$, prove that

$$[c, d] \cong [e, f] \cong (c, d) \cong (e, f).$$

- (iv) Deduce that for any real numbers a and b with $a < b$,

$$[0, 1) \cong (-\infty, a] \cong [a, \infty) \cong [a, b) \cong (a, b).$$

2. Prove that $\mathbb{Z} \cong \mathbb{N}$
 3. Let m and c be real numbers and X the subspace of \mathbb{R}^2 given by $X = \{\langle x, y \rangle : y = mx + c\}$. Prove that X is homeomorphic to \mathbb{R} .
 4. (i) Let X_1 and X_2 be the closed rectangular regions in \mathbb{R}^2 given by

$$X_1 = \{\langle x, y \rangle : |x| \leq a_1 \text{ and } |y| \leq b_1\}$$

and

$$X_2 = \{\langle x, y \rangle : |x| \leq a_2 \text{ and } |y| \leq b_2\}$$

where a_1, b_1, a_2 , and b_2 are positive real numbers. If X_1 and X_2 are given their induced topologies, \mathcal{T}_1 and \mathcal{T}_2 respectively, from \mathbb{R}^2 , show that $X_1 \cong X_2$.

- (ii) Let D_1 and D_2 be the closed discs in \mathbb{R}^2 given by

$$D_1 = \{\langle x, y \rangle : x^2 + y^2 \leq c_1\}$$

and

$$D_2 = \{\langle x, y \rangle : x^2 + y^2 \leq c_2\}$$

where c_1 and c_2 are positive real numbers. Prove that the topological space $D_1 \cong D_2$, where D_1 and D_2 have their subspace topologies.

- (iii) Prove that $X_1 \cong D_1$.

5. Let X_1 and X_2 be subspaces of \mathbb{R} given by $X_1 = (0, 1) \cup (3, 4)$ and $X_2 = (0, 1) \cup (1, 2)$. Is $X_1 \cong X_2$? (Justify your answer.)

Group of Homeomorphisms

6. (**Group of Homeomorphisms**) Let (X, \mathcal{T}) be any topological space and G the set of all homeomorphisms of X into itself.
- (i) Show that G is a group under the operation of composition of functions.
 - (ii) If $X = [0, 1]$, show that G is infinite.
 - (iii) If $X = [0, 1]$, is G an abelian group?
7. Let (X, \mathcal{T}) and (Y, \mathcal{T}_1) be homeomorphic topological spaces. Prove that
- (i) If (X, \mathcal{T}) is a T_0 -space, then (Y, \mathcal{T}_1) is a T_0 -space.
 - (ii) If (X, \mathcal{T}) is a T_1 -space, then (Y, \mathcal{T}_1) is a T_1 -space.
 - (iii) If (X, \mathcal{T}) is a Hausdorff space, then (Y, \mathcal{T}_1) is a Hausdorff space.
 - (iv) If (X, \mathcal{T}) satisfies the second axiom of countability, then (Y, \mathcal{T}_1) satisfies the second axiom of countability.
 - (v) If (X, \mathcal{T}) is a separable space, then (Y, \mathcal{T}_1) is a separable space.
- 8.* Let (X, \mathcal{T}) be a discrete topological space. Prove that (X, \mathcal{T}) is homeomorphic to a subspace of \mathbb{R} if and only if X is countable.

4.3 Non-Homeomorphic Spaces

To prove two topological spaces are homeomorphic we have to find a homeomorphism between them.

But, to prove that two topological spaces are not homeomorphic is often much harder as we have to show that no homeomorphism exists. The following example gives us a clue as to how we might go about showing this.

4.3.1 Example. Prove that $[0, 2]$ is not homeomorphic to the subspace $[0, 1] \cup [2, 3]$ of \mathbb{R} .

Proof. Let $(X, \mathcal{T}) = [0, 2]$ and $(Y, \mathcal{T}_1) = [0, 1] \cup [2, 3]$. Then

$$[0, 1] = [0, 1] \cap Y \Rightarrow [0, 1] \text{ is closed in } (Y, \mathcal{T}_1)$$

and $[0, 1] = (-1, 1\frac{1}{2}) \cap Y \Rightarrow [0, 1]$ is open in (Y, \mathcal{T}_1) .

Thus Y is not connected, as it has $[0, 1]$ as a proper non-empty clopen subset.

Suppose that $(X, \mathcal{T}) \cong (Y, \mathcal{T}_1)$. Then there exists a homeomorphism $f: (X, \mathcal{T}) \rightarrow (Y, \mathcal{T}_1)$. So $f^{-1}([0, 1])$ is a proper non-empty clopen subset of X , and hence X is not connected. This is false as $[0, 2] = X$ is connected. (See [Exercises 4.1 #15.](#)) So we have a contradiction and thus $(X, \mathcal{T}) \not\cong (Y, \mathcal{T}_1)$. \square

What do we learn from this?

4.3.2 Proposition. Any topological space homeomorphic to a connected space is connected. \square

[Proposition 4.3.2](#) gives us one way to try to show two topological spaces are not homeomorphic ... by finding a property “preserved by homeomorphisms” which one space has and the other does not.

We have met many properties “preserved by homeomorphisms” amongst the exercises:

- (i) T_0 -space;
- (ii) T_1 -space;
- (iii) T_2 -space or Hausdorff space;
- (iv) regular space;
- (v) T_3 -space;
- (vi) satisfying the second axiom of countability;
- (vii) separable space. [See [Exercises 4.2 #7.](#)]

There are also others:

- (viii) discrete space;
- (ix) indiscrete space;
- (x) finite-closed topology;
- (xi) countable-closed topology.

So together with connectedness we know twelve properties which are preserved by homeomorphisms. Also two spaces (X, \mathcal{T}) and (Y, \mathcal{T}_1) cannot be homeomorphic if X and Y have different cardinalities (e.g. X is countable and Y is uncountable) or if \mathcal{T} and \mathcal{T}_1 have different cardinalities.

Nevertheless when faced with a specific problem we may not have the one we need. For example, show that $(0, 1)$ is not homeomorphic to $[0, 1]$ or show that \mathbb{R} is not homeomorphic to \mathbb{R}^2 . We shall see how to show that these spaces are not homeomorphic shortly.

Before moving on to this let us settle the following question: which subspaces of \mathbb{R} are connected?

4.3.3 Definition. A subset S of \mathbb{R} is said to be an **interval** if it has the following property: if $x \in S$, $z \in S$, and $y \in \mathbb{R}$ are such that $x < y < z$, then $y \in S$.

4.3.4 Remarks. Note the following:

- (i) Each singleton set $\{x\}$ is an interval.
- (ii) Every interval has one of the following forms: $\{a\}$, $[a, b]$, (a, b) , $[a, b)$, $(a, b]$, $(-\infty, a)$, $(-\infty, a]$, (a, ∞) , $[a, \infty)$, $(-\infty, \infty)$.
- (iii) It follows from [Example 4.2.6](#), [Remark 4.2.7](#), and [Exercises 4.2 #1](#), that every interval is homeomorphic to $(0, 1)$, $[0, 1]$, $[0, 1)$, or $\{0\}$. In [Exercises 4.3 #1](#) we are able to make an even stronger statement.

4.3.5 Proposition. A subspace S of \mathbb{R} is connected if and only if it is an interval.

Proof. That all intervals are connected can be proved in a similar fashion to [Proposition 3.3.3](#) by replacing \mathbb{R} everywhere in the proof by the interval we are trying to prove connected.

Conversely, let S be connected. Suppose $x \in S$, $z \in S$, $x < y < z$, and $y \notin S$. Then $(-\infty, y) \cap S = (-\infty, y] \cap S$ is an open and closed subset of S . So S has a clopen subset, namely $(-\infty, y) \cap S$. To show that S is not connected we have to verify only that this clopen set is proper and non-empty. It is non-empty as it contains x . It is proper as $z \in S$ but $z \notin (-\infty, y) \cap S$. So S is not connected. This is a contradiction. Therefore S is an interval. \square

We now see a reason for the name “connected”. Subspaces of \mathbb{R} such as $[a, b]$, (a, b) , etc. are connected, while subspaces like $X = [0, 1] \cup [2, 3] \cup [5, 6]$, which is a union of “disconnected” pieces, are not connected.

Now let us turn to the problem of showing that $(0, 1) \not\cong [0, 1]$. Firstly, we present a seemingly trivial observation.

4.3.6 Remark. Let $f : (X, \mathcal{T}) \rightarrow (Y, \mathcal{T}_1)$ be a homeomorphism. Let $a \in X$, so that $X \setminus \{a\}$ is a subspace of X and has induced topology \mathcal{T}_2 . Also $Y \setminus \{f(a)\}$ is a subspace of Y and has induced topology \mathcal{T}_3 . Then $(X \setminus \{a\}, \mathcal{T}_2)$ is homeomorphic to $(Y \setminus \{f(a)\}, \mathcal{T}_3)$.

Outline Proof. Define $g: X \setminus \{a\} \rightarrow Y \setminus \{f(a)\}$ by $g(x) = f(x)$, for all $x \in X \setminus \{a\}$. Then it is easily verified that g is a homeomorphism. (Write down a proof of this.) \square

As an immediate consequence of this we have:

4.3.7 Corollary. If a, b, c , and d are real numbers with $a < b$ and $c < d$, then

- (i) $(a, b) \not\cong [c, d]$,
- (ii) $(a, b) \not\cong [c, d]$, and
- (iii) $[a, b) \not\cong [c, d]$.

Proof. (i) Let $(X, \mathcal{T}) = [c, d]$ and $(Y, \mathcal{T}_1) = (a, b)$. Suppose that $(X, \mathcal{T}) \cong (Y, \mathcal{T}_1)$. Then $X \setminus \{c\} \cong Y \setminus \{y\}$, for some $y \in Y$. But, $X \setminus \{c\} = (c, d)$ is an interval, and so is connected, while no matter which point we remove from (a, b) the resultant space is disconnected. Hence by [Proposition 4.3.2](#),

$$X \setminus \{c\} \not\cong Y \setminus \{y\}, \text{ for each } y \in Y.$$

This is a contradiction. So $[c, d] \not\cong (a, b)$.

(ii) $[c, d] \setminus \{c\}$ is connected, while $(a, b) \setminus \{y\}$ is disconnected for all $y \in (a, b)$. Thus $(a, b) \not\cong [c, d]$.

(iii) Suppose that $[a, b) \cong [c, d]$. Then $[c, d] \setminus \{c\} \cong [a, b) \setminus \{y\}$ for some $y \in [a, b)$. Therefore $([c, d] \setminus \{c\}) \setminus \{d\} \cong ([a, b) \setminus \{y\}) \setminus \{z\}$, for some $z \in [a, b) \setminus \{y\}$; that is, $(c, d) \cong [a, b) \setminus \{y, z\}$, for some distinct y and z in $[a, b)$. But (c, d) is connected, while $[a, b) \setminus \{y, z\}$, for any two distinct points y and z in $[a, b)$, is disconnected. So we have a contradiction. Therefore $[a, b) \not\cong [c, d]$. \square

Exercises 4.3

1. Deduce from the above that every interval is homeomorphic to one and only one of the following spaces:

$$\{0\}; \quad (0, 1); \quad [0, 1]; \quad [0, 1).$$

2. Deduce from [Proposition 4.3.5](#) that every countable subspace of \mathbb{R} with more than one point is disconnected. (In particular, \mathbb{Z} and \mathbb{Q} are disconnected.)
3. Let X be the unit circle in \mathbb{R}^2 ; that is, $X = \{\langle x, y \rangle : x^2 + y^2 = 1\}$ and has the subspace topology.
- (i) Show that $X \setminus \{\langle 1, 0 \rangle\}$ is homeomorphic to the open interval $(0, 1)$.
 - (ii) Deduce that $X \not\cong (0, 1)$ and $X \not\cong [0, 1]$.
 - (iii) Observing that for every point $a \in X$, the subspace $X \setminus \{a\}$ is connected, show that $X \not\cong [0, 1)$.
 - (iv) Deduce that X is not homeomorphic to any interval.

4. Let Y be the subspace of \mathbb{R}^2 given by

$$Y = \{\langle x, y \rangle : x^2 + y^2 = 1\} \cup \{\langle x, y \rangle : (x - 2)^2 + y^2 = 1\}$$

- (i) Is Y homeomorphic to the space X in [Exercise 3 above](#)?
- (ii) Is Y homeomorphic to an interval?

5. Let Z be the subspace of \mathbb{R}^2 given by

$$Z = \{\langle x, y \rangle : x^2 + y^2 = 1\} \cup \{\langle x, y \rangle : (x - 3/2)^2 + y^2 = 1\}.$$

Show that

- (i) Z is not homeomorphic to any interval, and
 - (ii) Z is not homeomorphic to X or Y , the spaces described in [Exercises 3](#) and [Exercise 4 above](#).
6. Prove that the Sorgenfrey line is not homeomorphic to \mathbb{R} , \mathbb{R}^2 , or any subspace of either of these spaces.

7. (i) Prove that the topological space in [Exercises 1.1 #5](#) (i) is not homeomorphic to the space in [Exercises 1.1 #9](#) (ii).
- (ii)* In [Exercises 1.1 #5](#), is $(X, \mathcal{T}_1) \cong (X, \mathcal{T}_2)$?
- (iii)* In [Exercises 1.1 # 9](#), is $(X, \mathcal{T}_2) \cong (X, \mathcal{T}_9)$?

Initial Segment Topology and Final Segment Topology

8. Let (X, \mathcal{T}) be a topological space, where X is an infinite set. Prove each of the following statements (originally proved by Ginsburg and Sands [158]).
- (i)* (X, \mathcal{T}) has a subspace homeomorphic to $(\mathbb{N}, \mathcal{T}_1)$, where either \mathcal{T}_1 is the indiscrete topology or $(\mathbb{N}, \mathcal{T}_1)$ is a T_0 -space.
- (ii)** Let (X, \mathcal{T}) be a T_1 -space. Then (X, \mathcal{T}) has a subspace homeomorphic to $(\mathbb{N}, \mathcal{T}_2)$, where \mathcal{T}_2 is either the finite-closed topology or the discrete topology.
- (iii) Deduce from (ii), that any infinite Hausdorff space contains an infinite discrete subspace and hence a subspace homeomorphic to \mathbb{N} with the discrete topology.
- (iv)** Let (X, \mathcal{T}) be a T_0 -space which has no infinite T_1 -subspaces. Then the space (X, \mathcal{T}) has a subspace homeomorphic to $(\mathbb{N}, \mathcal{T}_3)$, where \mathcal{T}_3 consists of \mathbb{N}, \emptyset , and all of the sets $\{1, 2, \dots, n\}$, $n \in \mathbb{N}$ or \mathcal{T}_3 consists of \mathbb{N}, \emptyset , and all of the sets $\{n, n + 1, \dots\}$, $n \in \mathbb{N}$.
- (v) Deduce from the above that every infinite topological space has a subspace homeomorphic to $(\mathbb{N}, \mathcal{T}_4)$ where \mathcal{T}_4 is the indiscrete topology, the discrete topology, the finite-closed topology, or one of the two topologies described in (iv), known as the **initial segment topology** and the **final segment topology**, respectively. Further, no two of these five topologies on \mathbb{N} are homeomorphic.

Local Homeomorphism

9. Let (X, \mathcal{T}) and (Y, \mathcal{T}_1) be topological spaces. A map $f : X \rightarrow Y$ is said to be a **local homeomorphism** if each point $x \in X$ has an open neighbourhood U such that the restriction of f to U maps U homeomorphically onto an open subspace V of (Y, \mathcal{T}_1) ; that is, if the topology induced on U by \mathcal{T} is \mathcal{T}_2 and the topology induced on $V = f(U)$ by \mathcal{T}_1 is \mathcal{T}_3 , then f is a homeomorphism of (U, \mathcal{T}_2) onto (V, \mathcal{T}_3) . The topological space (X, \mathcal{T}) is said to be **locally homeomorphic** to (Y, \mathcal{T}_1) if there exists a local homeomorphism of (X, \mathcal{T}) into (Y, \mathcal{T}_1) .
- (i) If (X, \mathcal{T}) and (Y, \mathcal{T}_1) are homeomorphic topological spaces, verify that (X, \mathcal{T}) is locally homeomorphic to (Y, \mathcal{T}_1) .
- (ii) If (X, \mathcal{T}) is an open subspace of (Y, \mathcal{T}_1) , prove that (X, \mathcal{T}) is locally homeomorphic to (Y, \mathcal{T}_1) .
- (iii)* Prove that if $f : (X, \mathcal{T}) \rightarrow (Y, \mathcal{T}_1)$ is a local homeomorphism, then f maps every open subset of (X, \mathcal{T}) onto an open subset of (Y, \mathcal{T}_1) .
10. A subset A of a topological space (X, \mathcal{T}) is said to be **semi-open** if there exists an open set $O \in (X, \mathcal{T})$ such that $O \subseteq A \subseteq \overline{O}$. Verify the following:
- (i) every open set is a semi-open set;
- (ii) a closed set is not necessarily a semi-open set;
- (iii) if A is an interval other than a singleton set in \mathbb{R} , then A is a semi-open subset of \mathbb{R} ;
- (iv) if \mathcal{T} is the finite-closed topology, the discrete topology or the indiscrete topology then the semi-open sets are precisely the open sets.

4.4 Postscript

There are three important ways of creating new topological spaces from old ones: forming subspaces, products, and quotient spaces. We examine all three in due course. Forming subspaces was studied in this chapter. This allowed us to introduce the important spaces \mathbb{Q} , $[a, b]$, (a, b) , etc.

We defined the central notion of homeomorphism. We noted that “ \cong ” is an equivalence relation. A property is said to be **topological** if it is preserved by homeomorphisms; that is, if $(X, \mathcal{T}) \cong (Y, \mathcal{T}_1)$ and (X, \mathcal{T}) has the property then (Y, \mathcal{T}_1) must also have the property. Connectedness was shown to be a topological property. So any space homeomorphic to a connected space is connected. (A number of other topological properties were also identified.) We formally defined the notion of an interval in \mathbb{R} , and showed that the intervals are precisely the connected subspaces of \mathbb{R} .

Given two topological spaces (X, \mathcal{T}) and (Y, \mathcal{T}_1) it is an interesting task to show whether they are homeomorphic or not. We proved that every interval in \mathbb{R} is homeomorphic to one and only one of $[0, 1]$, $(0, 1)$, $[0, 1)$, and $\{0\}$. In the next section we show that \mathbb{R} is not homeomorphic to \mathbb{R}^2 . A tougher problem is to show that \mathbb{R}^2 is not homeomorphic to \mathbb{R}^3 . This will be done later via the Jordan curve theorem. Still the crème de la crème is the fact that $\mathbb{R}^n \cong \mathbb{R}^m$ if and only if $n = m$. This is best approached via algebraic topology, which is only touched upon in this book.

[Exercises 4.2 #6](#) introduced the notion of group of homeomorphisms, which is an interesting and important topic in its own right.

Chapter 5

Continuous Mappings

Introduction

In most branches of pure mathematics we study what in category theory are called “objects” and “arrows”. In linear algebra the objects are vector spaces and the arrows are linear transformations. In group theory the objects are groups and the arrows are homomorphisms, while in set theory the objects are sets and the arrows are functions. In topology the objects are the topological spaces. We now introduce the arrows . . . the continuous mappings.

5.1 Continuous Mappings

Of course we are already familiar¹ with the notion of a continuous function from \mathbb{R} into \mathbb{R} .

A function $f : \mathbb{R} \rightarrow \mathbb{R}$ is said to be **continuous** if for each $a \in \mathbb{R}$ and each positive real number ε , there exists a positive real number δ such that $|x - a| < \delta$ implies $|f(x) - f(a)| < \varepsilon$.

It is not at all obvious how to generalize this definition to general topological spaces where we do not have “absolute value” or “subtraction”. So we shall seek another (equivalent) definition of continuity which lends itself more to generalization.

¹The early part of this section assumes that you have some knowledge of real analysis and, in particular, the ε - δ definition of continuity. If this is not the case, then proceed directly to [Definition 5.1.3](#). If you would like to refresh your knowledge in this area, you might like to look at the classic book “A course of pure mathematics” by G.H. Hardy, which is available to download at no cost from Project Gutenberg at <http://www.gutenberg.org/ebooks/38769>.

It is easily seen that $f : \mathbb{R} \rightarrow \mathbb{R}$ is continuous if and only if for each $a \in \mathbb{R}$ and each interval $(f(a) - \varepsilon, f(a) + \varepsilon)$, for $\varepsilon > 0$, there exists a $\delta > 0$ such that $f(x) \in (f(a) - \varepsilon, f(a) + \varepsilon)$ for all $x \in (a - \delta, a + \delta)$.

This definition is an improvement since it does not involve the concept “absolute value” but it still involves “subtraction”. The next lemma shows how to avoid subtraction.

5.1.1 Lemma. Let f be a function mapping \mathbb{R} into itself. Then f is continuous if and only if for each $a \in \mathbb{R}$ and each open set U containing $f(a)$, there exists an open set V containing a such that $f(V) \subseteq U$.

Proof. Assume that f is continuous. Let $a \in \mathbb{R}$ and let U be any open set containing $f(a)$. Then there exist real numbers c and d such that $f(a) \in (c, d) \subseteq U$. Put ε equal to the smaller of the two numbers $d - f(a)$ and $f(a) - c$, so that

$$(f(a) - \varepsilon, f(a) + \varepsilon) \subseteq U.$$

As the mapping f is continuous there exists a $\delta > 0$ such that $f(x) \in (f(a) - \varepsilon, f(a) + \varepsilon)$ for all $x \in (a - \delta, a + \delta)$. Let V be the open set $(a - \delta, a + \delta)$. Then $a \in V$ and $f(V) \subseteq U$, as required.

Conversely assume that for each $a \in \mathbb{R}$ and each open set U containing $f(a)$ there exists an open set V containing a such that $f(V) \subseteq U$. We have to show that f is continuous. Let $a \in \mathbb{R}$ and ε be any positive real number. Put $U = (f(a) - \varepsilon, f(a) + \varepsilon)$. So U is an open set containing $f(a)$. Therefore there exists an open set V containing a such that $f(V) \subseteq U$. As V is an open set containing a , there exist real numbers c and d such that $a \in (c, d) \subseteq V$. Put δ equal to the smaller of the two numbers $d - a$ and $a - c$, so that $(a - \delta, a + \delta) \subseteq V$. Then for all $x \in (a - \delta, a + \delta)$, $f(x) \in f(V) \subseteq U$, as required. So f is continuous. \square

We could use the property described in [Lemma 5.1.1](#) to define continuity, however the following lemma allows us to make a more elegant definition.

5.1.2 Lemma. Let f be a mapping of a topological space (X, \mathcal{T}) into a topological space (Y, \mathcal{T}') . Then the following two conditions are equivalent:

- (i) for each $U \in \mathcal{T}'$, $f^{-1}(U) \in \mathcal{T}$;
- (ii) for each $a \in X$ and each $U \in \mathcal{T}'$ with $f(a) \in U$, there exists a $V \in \mathcal{T}$ such that $a \in V$ and $f(V) \subseteq U$.

Proof. Assume that condition (i) is satisfied. Let $a \in X$ and $U \in \mathcal{T}'$ with $f(a) \in U$. Then $f^{-1}(U) \in \mathcal{T}$. Put $V = f^{-1}(U)$, and we have that $a \in V$, $V \in \mathcal{T}$, and $f(V) \subseteq U$. So condition (ii) is satisfied.

Conversely, assume that condition (ii) is satisfied. Let $U \in \mathcal{T}'$. If $f^{-1}(U) = \emptyset$ then clearly $f^{-1}(U) \in \mathcal{T}$. If $f^{-1}(U) \neq \emptyset$, let $a \in f^{-1}(U)$. Then $f(a) \in U$. Therefore there exists a $V \in \mathcal{T}$ such that $a \in V$ and $f(V) \subseteq U$. So for each $a \in f^{-1}(U)$ there exists a $V \in \mathcal{T}$ such that $a \in V \subseteq f^{-1}(U)$. By [Corollary 3.2.9](#) this implies that $f^{-1}(U) \in \mathcal{T}$. So condition (i) is satisfied. \square

Putting together [Lemmas 5.1.1](#) and [5.1.2](#) we see that $f : \mathbb{R} \rightarrow \mathbb{R}$ is continuous if and only if for each open subset U of \mathbb{R} , $f^{-1}(U)$ is an open set.

This leads us to define the notion of a continuous function between two topological spaces as follows:

5.1.3 Definition. Let (X, \mathcal{T}) and (Y, \mathcal{T}_1) be topological spaces and f a function from X into Y . Then $f : (X, \mathcal{T}) \rightarrow (Y, \mathcal{T}_1)$ is said to be a **continuous mapping** if for each $U \in \mathcal{T}_1$, $f^{-1}(U) \in \mathcal{T}$.

From the above remarks we see that this definition of continuity coincides with the usual definition when $(X, \mathcal{T}) = (Y, \mathcal{T}_1) = \mathbb{R}$.

Let us go through a few easy examples to see how nice this definition of continuity is to apply in practice.

5.1.4 Example. Consider $f : \mathbb{R} \rightarrow \mathbb{R}$ given by $f(x) = x$, for all $x \in \mathbb{R}$; that is, f is the identity function. Then for any open set U in \mathbb{R} , $f^{-1}(U) = U$ and so is open. Hence f is continuous. \square

5.1.5 Example. Let $f : \mathbb{R} \rightarrow \mathbb{R}$ be given by $f(x) = c$, for c a constant, and all $x \in \mathbb{R}$. Then let U be any open set in \mathbb{R} . Clearly $f^{-1}(U) = \mathbb{R}$ if $c \in U$ and \emptyset if $c \notin U$. In both cases, $f^{-1}(U)$ is open. So f is continuous. \square

5.1.6 Example. Consider $f : \mathbb{R} \rightarrow \mathbb{R}$ defined by

$$f(x) = \begin{cases} x - 1, & \text{if } x \leq 3 \\ \frac{1}{2}(x + 5), & \text{if } x > 3. \end{cases}$$

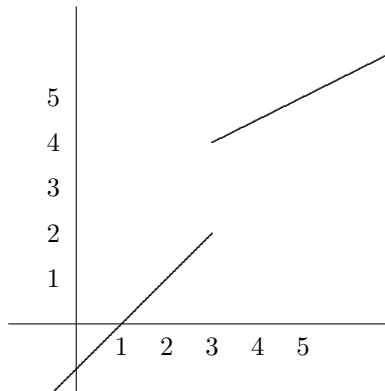

Recall that a mapping is continuous if and only if the inverse image of every open set is an open set.

Therefore, to show f is not continuous we have to find only one set U such that $f^{-1}(U)$ is not open.

Then $f^{-1}((1, 3)) = (2, 3]$, which is not an open set. Therefore f is not continuous. \square

Note that [Lemma 5.1.2](#) can now be restated in the following way.²

5.1.7 Proposition. Let f be a mapping of a topological space (X, \mathcal{T}) into a space (Y, \mathcal{T}') . Then f is continuous if and only if for each $x \in X$ and each $U \in \mathcal{T}'$ with $f(x) \in U$, there exists a $V \in \mathcal{T}$ such that $x \in V$ and $f(V) \subseteq U$. \square

5.1.8 Proposition. Let $(X, \mathcal{T}), (Y, \mathcal{T}_1)$ and (Z, \mathcal{T}_2) be topological spaces. If $f : (X, \mathcal{T}) \rightarrow (Y, \mathcal{T}_1)$ and $g : (Y, \mathcal{T}_1) \rightarrow (Z, \mathcal{T}_2)$ are continuous mappings, then the composite function $g \circ f : (X, \mathcal{T}) \rightarrow (Z, \mathcal{T}_2)$ is continuous.

Proof.

To prove that the composite function $g \circ f : (X, \tau) \rightarrow (Z, \tau_2)$ is continuous, we have to show that if $U \in \tau_2$, then $(g \circ f)^{-1}(U) \in \tau$.

$$\text{But } (g \circ f)^{-1}(U) = f^{-1}(g^{-1}(U)).$$

Let U be open in (Z, \mathcal{T}_2) . Since g is continuous, $g^{-1}(U)$ is open in \mathcal{T}_1 . Then $f^{-1}(g^{-1}(U))$ is open in \mathcal{T} as f is continuous. But $f^{-1}(g^{-1}(U)) = (g \circ f)^{-1}(U)$. Thus $g \circ f$ is continuous. \square

The next result shows that continuity can be described in terms of closed sets instead of open sets if we wish.

5.1.9 Proposition. Let (X, \mathcal{T}) and (Y, \mathcal{T}_1) be topological spaces. Then $f : (X, \mathcal{T}) \rightarrow (Y, \mathcal{T}_1)$ is continuous if and only if for every closed subset S of Y , $f^{-1}(S)$ is a closed subset of X .

Proof. This result follows immediately once you recognize that

$$f^{-1}(\text{complement of } S) = \text{complement of } f^{-1}(S). \quad \square$$

²If you have not read [Lemma 5.1.2](#) and its proof you should do so now.

5.1.10 Remark. Of course here is a relationship between continuous maps and homeomorphisms: if $f : (X, \mathcal{T}) \rightarrow (Y, \mathcal{T}_1)$ is a homeomorphism then it is a continuous map. Of course not every continuous map is a homeomorphism.

However the following proposition, whose proof follows from the definitions of “continuous” and “homeomorphism” tells the full story.

5.1.11 Proposition. Let (X, \mathcal{T}) and (Y, \mathcal{T}') be topological spaces and f a function from X into Y . Then f is a homeomorphism if and only if

- (i) f is continuous,
- (ii) f is one-to-one and onto; that is, the inverse function $f^{-1} : Y \rightarrow X$ exists, and
- (iii) f^{-1} is continuous. □

A useful result is the following proposition which tells us that the restriction of a continuous map is a continuous map. Its routine proof is left to the reader – see also [Exercises 5.1 #8](#).

5.1.12 Proposition. Let (X, \mathcal{T}) and (Y, \mathcal{T}_1) be topological spaces, $f : (X, \mathcal{T}) \rightarrow (Y, \mathcal{T}_1)$ a continuous mapping, A a subset of X , and \mathcal{T}_2 the induced topology on A . Further let $g : (A, \mathcal{T}_2) \rightarrow (Y, \mathcal{T}_1)$ be the restriction of f to A ; that is, $g(x) = f(x)$, for all $x \in A$. Then g is continuous.

Exercises 5.1

1. (i) Let $f : (X, \mathcal{T}) \rightarrow (Y, \mathcal{T}_1)$ be a constant function. Show that f is continuous.
 (ii) Let $f : (X, \mathcal{T}) \rightarrow (X, \mathcal{T})$ be the identity function. Show that f is continuous.
2. Let $f : \mathbb{R} \rightarrow \mathbb{R}$ be given by

$$f(x) = \begin{cases} -1, & x \leq 0 \\ 1, & x > 0. \end{cases}$$

- (i) Prove that f is not continuous using the method of [Example 5.1.6](#).
- (ii) Find $f^{-1}\{1\}$ and, using [Proposition 5.1.9](#), deduce that f is not continuous.

3. Let $f : \mathbb{R} \rightarrow \mathbb{R}$ be given by

$$f(x) = \begin{cases} x, & x \leq 1 \\ x + 2, & x > 1. \end{cases}$$

Is f continuous? (Justify your answer.)

4. Let (X, \mathcal{T}) be the subspace of \mathbb{R} given by $X = [0, 1] \cup [2, 4]$. Define $f : (X, \mathcal{T}) \rightarrow \mathbb{R}$ by

$$f(x) = \begin{cases} 1, & \text{if } x \in [0, 1] \\ 2, & \text{if } x \in [2, 4]. \end{cases}$$

Prove that f is continuous. (Does this surprise you?)

5. Let (X, \mathcal{T}) and (Y, \mathcal{T}_1) be topological spaces and \mathcal{B}_1 a basis for the topology \mathcal{T}_1 . Show that a map $f : (X, \mathcal{T}) \rightarrow (Y, \mathcal{T}_1)$ is continuous if and only if $f^{-1}(U) \in \mathcal{T}$, for every $U \in \mathcal{B}_1$.
6. Let (X, \mathcal{T}) and (Y, \mathcal{T}_1) be topological spaces and f a mapping of X into Y . If (X, \mathcal{T}) is a discrete space, prove that f is continuous.
7. Let (X, \mathcal{T}) and (Y, \mathcal{T}_1) be topological spaces and f a mapping of X into Y . If (Y, \mathcal{T}_1) is an indiscrete space, prove that f is continuous.
8. Let (X, \mathcal{T}) and (Y, \mathcal{T}_1) be topological spaces and $f : (X, \mathcal{T}) \rightarrow (Y, \mathcal{T}_1)$ a continuous mapping. Let A be a subset of X , \mathcal{T}_2 the induced topology on A , $B = f(A)$, \mathcal{T}_3 the induced topology on B and $g : (A, \mathcal{T}_2) \rightarrow (B, \mathcal{T}_3)$ the restriction of f to A . Prove that g is continuous.
9. Let f be a mapping of a space (X, \mathcal{T}) into a space (Y, \mathcal{T}') . Prove that f is continuous if and only if for each $x \in X$ and each neighbourhood N of $f(x)$ there exists a neighbourhood M of x such that $f(M) \subseteq N$.

Coarser Topology and Finer Topology

10. Let \mathcal{T}_1 and \mathcal{T}_2 be two topologies on a set X . Then \mathcal{T}_1 is said to be a **finer topology** than \mathcal{T}_2 (and \mathcal{T}_2 is said to be a **coarser topology** than \mathcal{T}_1) if $\mathcal{T}_1 \supseteq \mathcal{T}_2$. Prove that
- (i) the Euclidean topology \mathbb{R} is finer than the finite-closed topology on \mathbb{R} ;
- (ii) the identity function $f : (X, \mathcal{T}_1) \rightarrow (X, \mathcal{T}_2)$ is continuous if and only if \mathcal{T}_1 is a finer topology than \mathcal{T}_2 .

11. Let $f : \mathbb{R} \rightarrow \mathbb{R}$ be a continuous function such that $f(q) = 0$ for every rational number q . Prove that $f(x) = 0$ for every $x \in \mathbb{R}$.
12. Let (X, \mathcal{T}) and (Y, \mathcal{T}_1) be topological spaces and $f : (X, \mathcal{T}) \rightarrow (Y, \mathcal{T}_1)$ a continuous map. If f is one-to-one, prove that
- (i) (Y, \mathcal{T}_1) Hausdorff implies (X, \mathcal{T}) Hausdorff.
 - (ii) (Y, \mathcal{T}_1) a T_1 -space implies (X, \mathcal{T}) is a T_1 -space.
13. Let (X, \mathcal{T}) and (Y, \mathcal{T}_1) be topological spaces and let f be a mapping of (X, \mathcal{T}) into (Y, \mathcal{T}_1) . Prove that f is continuous if and only if for every subset A of X , $f(\overline{A}) \subseteq \overline{f(A)}$.

[Hint: Use [Proposition 5.1.9](#).]

5.2 Intermediate Value Theorem

5.2.1 Proposition. Let (X, \mathcal{T}) and (Y, \mathcal{T}_1) be topological spaces and $f : (X, \mathcal{T}) \rightarrow (Y, \mathcal{T}_1)$ surjective and continuous. If (X, \mathcal{T}) is connected, then (Y, \mathcal{T}_1) is connected.

Proof. Suppose (Y, \mathcal{T}_1) is not connected. Then it has a clopen subset U such that $U \neq \emptyset$ and $U \neq Y$. Then $f^{-1}(U)$ is an open set, since f is continuous, and also a closed set, by [Proposition 5.1.9](#); that is, $f^{-1}(U)$ is a clopen subset of X . Now $f^{-1}(U) \neq \emptyset$ as f is surjective and $U \neq \emptyset$. Also $f^{-1}(U) \neq X$, since if it were U would equal Y , by the surjectivity of f . Thus (X, \mathcal{T}) is not connected. This is a contradiction. Therefore (Y, \mathcal{T}_1) is connected. \square

5.2.2 Remarks. (i) The above proposition would be false if the condition “surjective” were dropped. (Find an example of this.)

(ii) Simply put, [Proposition 5.2.1](#) says: **any continuous image of a connected space is connected.**

(iii) **Proposition 5.2.1** tells us that if (X, \mathcal{T}) is a connected space and (Y, \mathcal{T}') is not connected (i.e. **disconnected**) then there exists no mapping of (X, \mathcal{T}) onto (Y, \mathcal{T}') which is continuous. For example, while there are an infinite number of mappings of \mathbb{R} onto \mathbb{Q} (or onto \mathbb{Z}), none of them are continuous. Indeed in **Exercises 5.2 # 10** we observe that the only continuous mappings of \mathbb{R} into \mathbb{Q} (or into \mathbb{Z}) are the constant mappings. \square

The following strengthened version of the notion of connectedness is often useful.

5.2.3 Definition. A topological space (X, \mathcal{T}) is said to be **path-connected** (or **pathwise connected**) if for each pair of (distinct) points a and b of X there exists a continuous mapping $f : [0, 1] \rightarrow (X, \mathcal{T})$, such that $f(0) = a$ and $f(1) = b$. The mapping f is said to be a **path joining a to b** .

5.2.4 Example. It is readily seen that every interval is path-connected. \square

5.2.5 Example. For each $n \geq 1$, \mathbb{R}^n is path-connected. \square

5.2.6 Proposition. Every path-connected space is connected.

Proof. Let (X, \mathcal{T}) be a path-connected space and suppose that it is not connected.

Then it has a proper non-empty clopen subset U . So there exist a and b such that $a \in U$ and $b \in X \setminus U$. As (X, \mathcal{T}) is path-connected there exists a continuous function $f : [0, 1] \rightarrow (X, \mathcal{T})$ such that $f(0) = a$ and $f(1) = b$.

However, $f^{-1}(U)$ is a clopen subset of $[0, 1]$. As $a \in U$, $0 \in f^{-1}(U)$ and so $f^{-1}(U) \neq \emptyset$. As $b \notin U$, $1 \notin f^{-1}(U)$ and thus $f^{-1}(U) \neq [0, 1]$. Hence $f^{-1}(U)$ is a proper non-empty clopen subset of $[0, 1]$, which contradicts the connectedness of $[0, 1]$.

Consequently (X, \mathcal{T}) is connected. \square

5.2.7 Remark. The converse of [Proposition 5.2.6](#) is false; that is, not every connected space is path-connected. An example of such a space is the following subspace of \mathbb{R}^2 :

$$X = \{\langle x, y \rangle : y = \sin(1/x), 0 < x \leq 1\} \cup \{\langle 0, y \rangle : -1 \leq y \leq 1\}.$$

[[Exercises 5.2 #6](#) shows that X is connected. That X is not path-connected can be seen by showing that there is no path joining $\langle 0, 0 \rangle$ to, say, the point $\langle 1/\pi, 0 \rangle$. Draw a picture and try to convince yourself of this.] \square

We can now show that $\mathbb{R} \not\cong \mathbb{R}^2$.

5.2.8 Example. Clearly $\mathbb{R}^2 \setminus \{\langle 0, 0 \rangle\}$ is path-connected and hence, by [Proposition 5.2.6](#), is connected. However, by [Proposition 4.3.5](#), $\mathbb{R} \setminus \{a\}$, for any $a \in \mathbb{R}$, is disconnected. Hence $\mathbb{R} \not\cong \mathbb{R}^2$. \square

We now present the Weierstrass Intermediate Value Theorem which is a beautiful application of topology to the theory of functions of a real variable. The topological concept crucial to the result is that of connectedness.

5.2.9 Theorem. (Weierstrass Intermediate Value Theorem)

Let $f : [a, b] \rightarrow \mathbb{R}$ be continuous and let $f(a) \neq f(b)$. Then for every number p between $f(a)$ and $f(b)$ there is a point $c \in [a, b]$ such that $f(c) = p$.

Proof. As $[a, b]$ is connected and f is continuous, [Proposition 5.2.1](#) says that $f([a, b])$ is connected. By [Proposition 4.3.5](#) this implies that $f([a, b])$ is an interval. Now $f(a)$ and $f(b)$ are in $f([a, b])$. So if p is between $f(a)$ and $f(b)$, $p \in f([a, b])$, that is, $p = f(c)$, for some $c \in [a, b]$. \square

5.2.10 Corollary. If $f : [a, b] \rightarrow \mathbb{R}$ is continuous and such that $f(a) > 0$ and $f(b) < 0$, then there exists an $x \in [a, b]$ such that $f(x) = 0$. \square

5.2.11 Corollary. (Fixed Point Theorem) Let f be a continuous mapping of $[0, 1]$ into $[0, 1]$. Then there exists a $z \in [0, 1]$ such that $f(z) = z$. (The point z is called a **fixed point**.)

Proof. If $f(0) = 0$ or $f(1) = 1$, the result is obviously true. Thus it suffices to consider the case when $f(0) > 0$ and $f(1) < 1$.

Let $g : [0, 1] \rightarrow \mathbb{R}$ be defined by $g(x) = x - f(x)$. Clearly g is continuous, $g(0) = -f(0) < 0$, and $g(1) = 1 - f(1) > 0$. Consequently, by Corollary 5.2.10, there exists a $z \in [0, 1]$ such that $g(z) = 0$; that is, $z - f(z) = 0$ or $f(z) = z$. \square

5.2.12 Remark. Corollary 5.2.11 is a special case of a very important theorem called the **Brouwer Fixed Point Theorem** which says that **if you map an n -dimensional cube continuously into itself then there is a fixed point**. [There are many proofs of this theorem, but most depend on methods of algebraic topology. An unsophisticated proof is given in Kuratowski [249] on pp. 238–239.]

Exercises 5.2

1. Prove that a continuous image of a path-connected space is path-connected.
2. Let f be a continuous mapping of the interval $[a, b]$ into itself, where a and $b \in \mathbb{R}$ and $a < b$. Prove that there is a fixed point.

Fixed Point Property

3. (i) Give an example which shows that Corollary 5.2.11 would be false if we replaced $[0, 1]$ everywhere by $(0, 1)$.
- (ii) A topological space (X, \mathcal{T}) is said to have the **fixed point property** if every continuous mapping of (X, \mathcal{T}) into itself has a fixed point. Show that the only intervals in \mathbb{R} having the fixed point property are the closed intervals.
- (iii) Let X be a set with at least two points. Prove that the discrete space (X, \mathcal{T}) and the indiscrete space (X, \mathcal{T}') do not have the fixed-point property.
- (iv) Does a space which has the finite-closed topology have the fixed-point property?
- (v) Prove that if the space (X, \mathcal{T}) has the fixed-point property and (Y, \mathcal{T}_1) is a space homeomorphic to (X, \mathcal{T}) , then (Y, \mathcal{T}_1) has the fixed-point property.

4. Let $\{A_j : j \in J\}$ be a family of connected subspaces of a topological space (X, \mathcal{T}) . If $\bigcap_{j \in J} A_j \neq \emptyset$, show that $\bigcup_{j \in J} A_j$ is connected.
5. Let A be a connected subspace of a topological space (X, \mathcal{T}) . Prove that \bar{A} is also connected. Indeed, show that if $A \subseteq B \subseteq \bar{A}$, then B is connected.
6. (i) Show that the subspace $Y = \{\langle x, y \rangle : y = \sin(1/x), 0 < x \leq 1\}$ of \mathbb{R}^2 is connected.
[Hint: Use [Proposition 5.2.1.](#)]
- (ii) Verify that $\bar{Y} = Y \cup \{\langle 0, y \rangle : -1 \leq y \leq 1\}$
- (iii) Using [Exercise 5](#), observe that \bar{Y} is connected.
7. Let E be the set of all points in \mathbb{R}^2 having both coordinates rational. Prove that the space $\mathbb{R}^2 \setminus E$ is path-connected.
- 8.* Let C be any countable subset of \mathbb{R}^2 . Prove that the space $\mathbb{R}^2 \setminus C$ is path-connected.

Connected Component

9. Let (X, \mathcal{T}) be a topological space and a any point in X . The **component in X of a** , $C_X(a)$, is defined to be the union of all connected subsets of X which contain a . Show that
- (i) $C_X(a)$ is connected. (Use [Exercise 4](#) above.)
- (ii) $C_X(a)$ is the largest connected set containing a .
- (iii) $C_X(a)$ is closed in X . (Use [Exercise 5](#) above.)

Totally Disconnected Spaces

10. A topological space (X, \mathcal{T}) is said to be **totally disconnected** if every non-empty connected subset is a singleton set. Prove the following statements.
- (i) (X, \mathcal{T}) is totally disconnected if and only if for each $a \in X$, $C_X(a) = \{a\}$.
(See the notation in [Exercise 9.](#))
- (ii) The set \mathbb{Q} of all rational numbers with the usual topology is totally disconnected.
- (iii) Indiscrete spaces with more than one point are not totally disconnected.
- (iv) If f is a continuous mapping of \mathbb{R} into \mathbb{Q} , prove that there exists a $c \in \mathbb{Q}$ such that $f(x) = c$, for all $x \in \mathbb{R}$; that is, the only continuous functions from \mathbb{R} to \mathbb{Q} are the constant functions.
- (v) Every subspace of a totally disconnected space is totally disconnected.
- (vi) Every countable subspace of \mathbb{R}^2 is totally disconnected.
- (vii) The Sorgenfrey line is totally disconnected.

11. (i) Using [Exercise 9](#), define, in the natural way, the “path-component” of a point in a topological space.
- (ii) Prove that, in any topological space, every path-component is a path-connected space.
- (iii) If (X, \mathcal{T}) is a topological space with the property that every point in X has a neighbourhood which is path-connected, prove that every path-component is an open set. Deduce that every path-component is also a closed set.
- (iv) Using (iii), show that an open subset of \mathbb{R}^2 is connected if and only if it is path-connected.
- 12.* Let A and B be subsets of a topological space (X, \mathcal{T}) . If A and B are both open or both closed, and $A \cup B$ and $A \cap B$ are both connected, show that A and B are connected.

Zero-Dimensional Spaces

13. A topological space (X, \mathcal{T}) is said to be **zero-dimensional** if there is a basis for the topology consisting of clopen sets. Prove the following statements.
- (i) \mathbb{Q} and \mathbb{I} are zero-dimensional spaces.
- (ii) A subspace of a zero-dimensional space is zero-dimensional.
- (iii) A zero-dimensional Hausdorff space is totally disconnected. (See [Exercise 10 above](#).)
- (iv) Every indiscrete space is zero-dimensional.
- (v) Every discrete space is zero-dimensional.
- (vi) A zero-dimensional T_0 -space is Hausdorff.
- (vii)* A subspace of \mathbb{R} is zero-dimensional if and only if it is totally disconnected.
14. Show that every local homeomorphism is a continuous mapping. (See [Exercises 4.3#9](#).)

5.3 Postscript

In this chapter we said that a mapping³ between topological spaces is called “continuous” if it has the property that the inverse image of every open set is an open set. This is an elegant definition and easy to understand. It contrasts with the one we meet in real analysis which was mentioned at the beginning of this section. We have generalized the real analysis definition, not for the sake of generalization, but rather to see what is really going on.

The [Weierstrass Intermediate Value Theorem](#) seems intuitively obvious, but we now see it follows from the fact that \mathbb{R} is connected and that any continuous image of a connected space is connected.

We introduced a stronger property than connected, namely path-connected. In many cases it is not sufficient to insist that a space be connected, it must be path-connected. This property plays an important role in algebraic topology.

We shall return to the Brouwer Fixed Point Theorem in due course. It is a powerful theorem. Fixed point theorems play important roles in various branches of mathematics including topology, functional analysis, and differential equations. They are still a topic of research activity today.

In [Exercises 5.2 #9](#) and [#10](#) we met the notions of “component” and “totally disconnected”. Both of these are important for an understanding of connectedness.

³**Warning:** Some books use the terms “mapping” and “map” to mean continuous mapping. We do not.

Chapter 6

Metric Spaces

Introduction

The most important class of topological spaces is the class of metric spaces. Metric spaces provide a rich source of examples in topology. But more than this, most of the applications of topology to analysis are via metric spaces.

The notion of metric space was introduced in 1906 by Maurice Fréchet and developed and named by Felix Hausdorff in 1914 (Hausdorff [173]).

6.1 Metric Spaces

6.1.1 Definition. Let X be a non-empty set and d a real-valued function defined on $X \times X$ such that for $a, b \in X$:

- (i) $d(a, b) \geq 0$ and $d(a, b) = 0$ if and only if $a = b$;
- (ii) $d(a, b) = d(b, a)$; and
- (iii) $d(a, c) \leq d(a, b) + d(b, c)$, [the triangle inequality] for all a, b and c in X .

Then d is said to be a **metric** on X , (X, d) is called a **metric space** and $d(a, b)$ is referred to as the **distance** between a and b .

6.1.2 Example. The function $d : \mathbb{R} \times \mathbb{R} \rightarrow \mathbb{R}$ given by

$$d(a, b) = |a - b|, \quad a, b \in \mathbb{R}$$

is a metric on the set \mathbb{R} since

- (i) $|a - b| \geq 0$, for all a and b in \mathbb{R} , and $|a - b| = 0$ if and only if $a = b$,
- (ii) $|a - b| = |b - a|$, and
- (iii) $|a - c| \leq |a - b| + |b - c|$. (Deduce this from $|x + y| \leq |x| + |y|$.)

We call d the **euclidean metric on \mathbb{R}** . □

6.1.3 Example. The function $d : \mathbb{R}^2 \times \mathbb{R}^2 \rightarrow \mathbb{R}$ given by

$$d(\langle a_1, a_2 \rangle, \langle b_1, b_2 \rangle) = \sqrt{(a_1 - b_1)^2 + (a_2 - b_2)^2}$$

is a metric on \mathbb{R}^2 called the **euclidean metric on \mathbb{R}^2** .

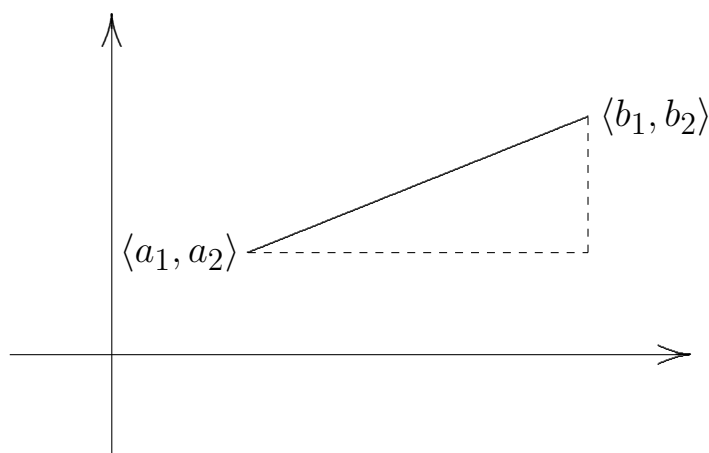

□

6.1.4 Example. Let X be a non-empty set and d the function from $X \times X$ into \mathbb{R} defined by

$$d(a, b) = \begin{cases} 0, & \text{if } a = b \\ 1, & \text{if } a \neq b. \end{cases}$$

Then d is a metric on X and is called the **discrete metric**. □

Many important examples of metric spaces are “function spaces”. For these the set X on which we put a metric is a set of functions.

6.1.5 Example. Let $C[0, 1]$ denote the set of continuous functions from $[0, 1]$ into \mathbb{R} . A metric is defined on this set by

$$d(f, g) = \int_0^1 |f(x) - g(x)| dx$$

where f and g are in $C[0, 1]$.

A moment's thought should tell you that $d(f, g)$ is precisely the area of the region which lies between the graphs of the functions and the lines $x = 0$ and $x = 1$, as illustrated below.

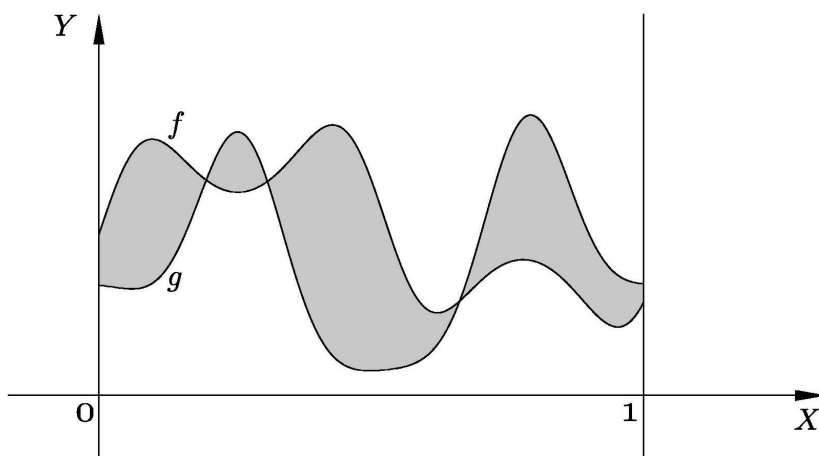

□

6.1.6 Example. Again let $C[0, 1]$ be the set of all continuous functions from $[0, 1]$ into \mathbb{R} . Another metric is defined on $C[0, 1]$ as follows:

$$d^*(f, g) = \sup\{|f(x) - g(x)| : x \in [0, 1]\}.$$

Clearly $d^*(f, g)$ is just the largest vertical gap between the graphs of the functions f and g .

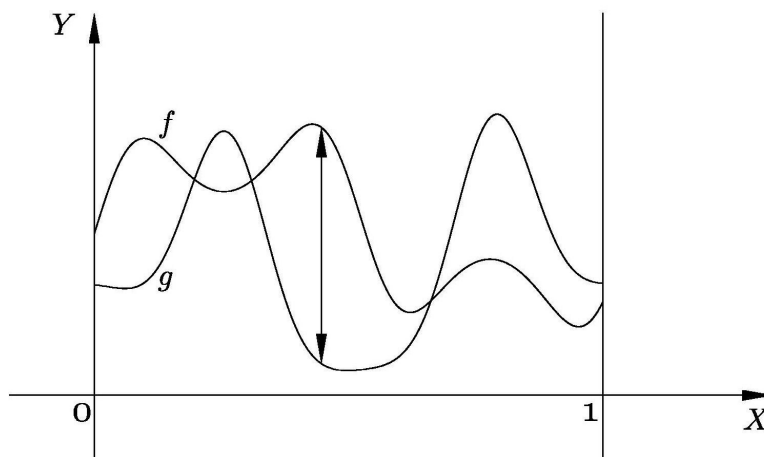

□

6.1.7 Example. We can define another metric on \mathbb{R}^2 by putting

$$d^*(\langle a_1, a_2 \rangle, \langle b_1, b_2 \rangle) = \max\{|a_1 - b_1|, |a_2 - b_2|\}$$

where $\max\{x, y\}$ equals the larger of the two numbers x and y .

□

6.1.8 Example. Yet another metric on \mathbb{R}^2 is given by

$$d_1(\langle a_1, a_2 \rangle, \langle b_1, b_2 \rangle) = |a_1 - b_1| + |a_2 - b_2|.$$

□

A rich source of examples of metric spaces is the family of normed vector spaces.

6.1.9 Example. Let V be a vector space over the field of real or complex numbers. A **norm** $\| \cdot \|$ on V is a map $\| \cdot \| : V \rightarrow \mathbb{R}$ such that for all $a, b \in V$ and λ in the field

- (i) $\| a \| \geq 0$ and $\| a \| = 0$ if and only if $a = 0$,
- (ii) $\| a + b \| \leq \| a \| + \| b \|$, and
- (iii) $\| \lambda a \| = |\lambda| \| a \|$.

A **normed vector space** $(V, \| \cdot \|)$ is a vector space V with a norm $\| \cdot \|$.

Let $(V, \| \cdot \|)$ be any normed vector space. Then there is a corresponding metric, d , on the set V given by $d(a, b) = \| a - b \|$, for a and b in V .

It is easily checked that d is indeed a metric. So **every normed vector space is also a metric space** in a natural way.

For example, \mathbb{R}^3 is a normed vector space if we put

$$\| \langle x_1, x_2, x_3 \rangle \| = \sqrt{x_1^2 + x_2^2 + x_3^2}, \quad \text{for } x_1, x_2, \text{ and } x_3 \text{ in } \mathbb{R}.$$

So \mathbb{R}^3 becomes a metric space if we put

$$\begin{aligned} d(\langle a_1, b_1, c_1 \rangle, \langle a_2, b_2, c_2 \rangle) &= \| (a_1 - a_2, b_1 - b_2, c_1 - c_2) \| \\ &= \sqrt{(a_1 - a_2)^2 + (b_1 - b_2)^2 + (c_1 - c_2)^2}. \end{aligned}$$

Indeed \mathbb{R}^n , for any positive integer n , is a normed vector space if we put

$$\| \langle x_1, x_2, \dots, x_n \rangle \| = \sqrt{x_1^2 + x_2^2 + \dots + x_n^2}.$$

So \mathbb{R}^n becomes a metric space if we put

$$\begin{aligned} d(\langle a_1, a_2, \dots, a_n \rangle, \langle b_1, b_2, \dots, b_n \rangle) &= \| \langle a_1 - b_1, a_2 - b_2, \dots, a_n - b_n \rangle \| \\ &= \sqrt{(a_1 - b_1)^2 + (a_2 - b_2)^2 + \dots + (a_n - b_n)^2}. \end{aligned}$$

□

In a normed vector space $(N, \| \cdot \|)$ the **open ball with centre a and radius r** is defined to be the set

$$B_r(a) = \{x : x \in N \text{ and } \|x - a\| < r\}.$$

This suggests the following definition for metric spaces:

6.1.10 Definition. Let (X, d) be a metric space and r any positive real number. Then the **open ball about $a \in X$ of radius r** is the set $B_r(a) = \{x : x \in X \text{ and } d(a, x) < r\}$.

6.1.11 Example. In \mathbb{R} with the euclidean metric $B_r(a)$ is the open interval $(a - r, a + r)$. □

6.1.12 Example. In \mathbb{R}^2 with the euclidean metric, $B_r(a)$ is the open disc with centre a and radius r .

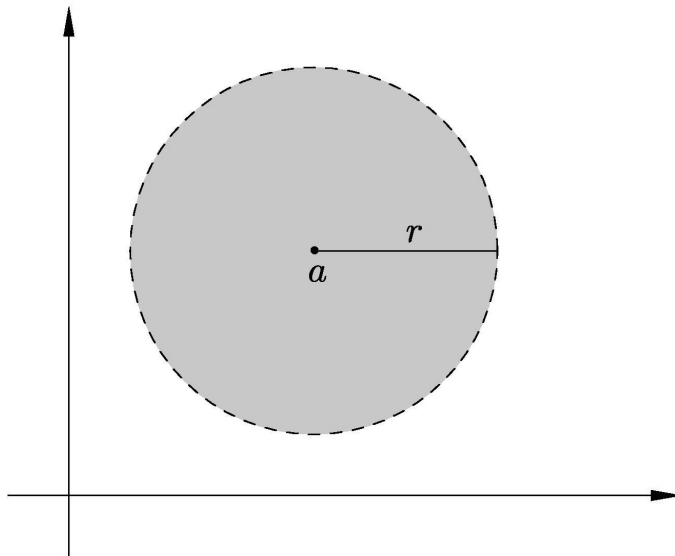

□

6.1.13 Example. In \mathbb{R}^2 with the metric d^* given by

$$d^*(\langle a_1, a_2 \rangle, \langle b_1, b_2 \rangle) = \max\{|a_1 - b_1|, |a_2 - b_2|\},$$

the open ball $B_1(\langle 0, 0 \rangle)$ looks like

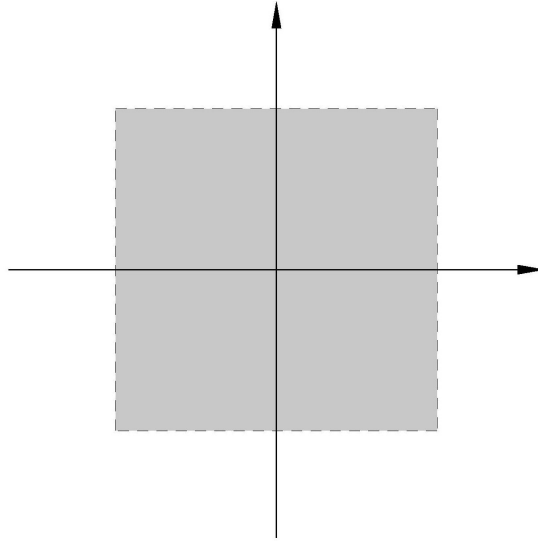

□

6.1.14 Example. In \mathbb{R}^2 with the metric d_1 given by

$$d_1(\langle a_1, a_2 \rangle, \langle b_1, b_2 \rangle) = |a_1 - b_1| + |a_2 - b_2|,$$

the open ball $B_1(\langle 0, 0 \rangle)$ looks like

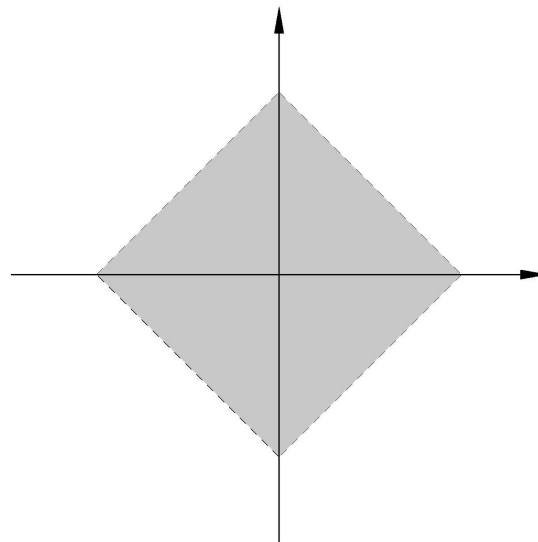

□

The proof of the following Lemma is quite easy (especially if you draw a diagram) and so is left for you to supply.

6.1.15 Lemma. Let (X, d) be a metric space and a and b points of X . Further, let δ_1 and δ_2 be positive real numbers. If $c \in B_{\delta_1}(a) \cap B_{\delta_2}(b)$, then there exists a $\delta > 0$ such that $B_\delta(c) \subseteq B_{\delta_1}(a) \cap B_{\delta_2}(b)$. \square

The next Corollary follows in a now routine way from [Lemma 6.1.15](#).

6.1.16 Corollary. Let (X, d) be a metric space and B_1 and B_2 open balls in (X, d) . Then $B_1 \cap B_2$ is a union of open balls in (X, d) . \square

Finally we are able to link metric spaces with topological spaces.

6.1.17 Proposition. Let (X, d) be a metric space. Then the collection of open balls in (X, d) is a basis for a topology \mathcal{T} on X .

[The topology \mathcal{T} is referred to as **the topology induced by the metric d** , and (X, \mathcal{T}) is called **the induced topological space** or **the corresponding topological space** or the **associated topological space**.]

Proof. This follows from [Proposition 2.2.8](#) and [Corollary 6.1.16](#). \square

6.1.18 Example. If d is the euclidean metric on \mathbb{R} then a basis for the topology \mathcal{T} induced by the metric d is the set of all open balls. But $B_\delta(a) = (a - \delta, a + \delta)$. From this it is readily seen that \mathcal{T} is the euclidean topology on \mathbb{R} . So **the euclidean metric on \mathbb{R} induces the euclidean topology on \mathbb{R}** . \square

6.1.19 Example. From Exercises 2.3 #1 (ii) and Example 6.1.12, it follows that the euclidean metric on the set \mathbb{R}^2 induces the euclidean topology on \mathbb{R}^2 . \square

6.1.20 Example. From Exercises 2.3 #1 (i) and Example 6.1.13 it follows that the metric d^* also induces the euclidean topology on the set \mathbb{R}^2 . \square

It is left as an exercise for you to prove that the metric d_1 of Example 6.1.14 also induces the euclidean topology on \mathbb{R}^2 .

6.1.21 Example. If d is the discrete metric on a set X then for each $x \in X$, $B_{\frac{1}{2}}(x) = \{x\}$. So all the singleton sets are open in the topology \mathcal{T} induced on X by d . Consequently, \mathcal{T} is the discrete topology. \square

We saw in Examples 6.1.19, 6.1.20, and 6.1.14 three different metrics on the same set which induce the same topology.

6.1.22 Definition. Metrics on a set X are said to be **equivalent** if they induce the same topology on X .

So the metrics d, d^* , and d_1 , of Examples 6.1.3, 6.1.13, and 6.1.14 on \mathbb{R}^2 are equivalent.

6.1.23 Proposition. Let (X, d) be a metric space and \mathcal{T} the topology induced on X by the metric d . Then a subset U of X is open in (X, \mathcal{T}) if and only if for each $a \in U$ there exists an $\varepsilon > 0$ such that the open ball $B_\varepsilon(a) \subseteq U$.

Proof. Assume that $U \in \mathcal{T}$. Then, by Propositions 2.3.2 and 6.1.17, for any $a \in U$ there exists a point $b \in X$ and a $\delta > 0$ such that $a \in B_\delta(b) \subseteq U$.

Let $\varepsilon = \delta - d(a, b)$. Then it is readily seen that

$$a \in B_\varepsilon(a) \subseteq U.$$

Conversely, assume that U is a subset of X with the property that for each $a \in U$ there exists an $\varepsilon_a > 0$ such that $B_{\varepsilon_a}(a) \subseteq U$. Then, by Propositions 2.3.3 and 6.1.17, U is an open set. \square

We have seen that every metric on a set X induces a topology on the set X . However, we shall now show that not every topology on a set is induced by a metric. First, a definition which you have already met in the exercises. (See [Exercises 4.1 #13.](#))

6.1.24 Definition. A topological space (X, \mathcal{T}) is said to be a **Hausdorff space** (or a **T_2 -space**) if for each pair of distinct points a and b in X , there exist open sets U and V such that $a \in U$, $b \in V$, and $U \cap V = \emptyset$.

Of course \mathbb{R} , \mathbb{R}^2 and all discrete spaces are examples of Hausdorff spaces, while any set with at least 2 elements and which has the indiscrete topology is not a Hausdorff space. With a little thought we see that \mathbb{Z} with the finite-closed topology is also not a Hausdorff space. (Convince yourself of all of these facts.)

6.1.25 Proposition. Let (X, d) be any metric space and \mathcal{T} the topology induced on X by d . Then (X, \mathcal{T}) is a Hausdorff space.

Proof. Let a and b be any points of X , with $a \neq b$. Then $d(a, b) > 0$. Put $\varepsilon = d(a, b)$. Consider the open balls $B_{\varepsilon/2}(a)$ and $B_{\varepsilon/2}(b)$. Then these are open sets in (X, \mathcal{T}) with $a \in B_{\varepsilon/2}(a)$ and $b \in B_{\varepsilon/2}(b)$. So to show \mathcal{T} is Hausdorff we have to prove only that $B_{\varepsilon/2}(a) \cap B_{\varepsilon/2}(b) = \emptyset$.

Suppose $x \in B_{\varepsilon/2}(a) \cap B_{\varepsilon/2}(b)$. Then $d(x, a) < \frac{\varepsilon}{2}$ and $d(x, b) < \frac{\varepsilon}{2}$. Hence

$$\begin{aligned} d(a, b) &\leq d(a, x) + d(x, b) \\ &< \frac{\varepsilon}{2} + \frac{\varepsilon}{2} = \varepsilon. \end{aligned}$$

This says $d(a, b) < \varepsilon$, which is false. Consequently there exists no x in $B_{\varepsilon/2}(a) \cap B_{\varepsilon/2}(b)$; that is, $B_{\varepsilon/2}(a) \cap B_{\varepsilon/2}(b) = \emptyset$, as required. \square

6.1.26 Remark. Putting [Proposition 6.1.25](#) together with the comments which preceded it, we see that an indiscrete space with at least two points has a topology which is not induced by any metric. Also \mathbb{Z} with the finite-closed topology \mathcal{T} is such that \mathcal{T} is not induced by any metric on \mathbb{Z} . \square

6.1.27 Definition. A space (X, \mathcal{T}) is said to be **metrizable** if there exists a metric d on the set X with the property that \mathcal{T} is the topology induced by d .

So, for example, the set \mathbb{Z} with the finite-closed topology is not a metrizable space.

Warning. One should not be misled by Proposition 6.1.25 into thinking that every Hausdorff space is metrizable. Later on we shall be able to produce (using infinite products) examples of Hausdorff spaces which are not metrizable. [Metrizability of topological spaces is quite a technical topic. For necessary and sufficient conditions for metrizability see Theorem 9.1, page 195, of the book Dugundji [113].]

Exercises 6.1

1. Prove that the metric d_1 of Example 6.1.8 induces the euclidean topology on \mathbb{R}^2 .
2. Let d be a metric on a non-empty set X .
 - (i) Show that the function e defined by $e(a, b) = \min\{1, d(a, b)\}$ where $a, b \in X$, is also a metric on X .
 - (ii) Prove that d and e are equivalent metrics.
 - (iii) A metric space (X, d) is said to be **bounded**, and d is said to be a **bounded metric**, if there exists a positive real number M such that $d(x, y) < M$, for all $x, y \in X$. Using (ii) deduce that every metric is equivalent to a bounded metric.
3. (i) Let d be a metric on a non-empty set X . Show that the function e defined by

$$e(a, b) = \frac{d(a, b)}{1 + d(a, b)}$$
 where $a, b \in X$, is also a metric on X .
 - (ii) Prove that d and e are equivalent metrics.

4. Let d_1 and d_2 be metrics on sets X and Y respectively. Prove that

(i) d is a metric on $X \times Y$, where

$$d(\langle x_1, y_1 \rangle, \langle x_2, y_2 \rangle) = \max\{d_1(x_1, x_2), d_2(y_1, y_2)\}.$$

(ii) e is a metric on $X \times Y$, where

$$e(\langle x_1, y_1 \rangle, \langle x_2, y_2 \rangle) = d_1(x_1, x_2) + d_2(y_1, y_2).$$

(iii) d and e are equivalent metrics.

5. Let (X, d) be a metric space and \mathcal{T} the corresponding topology on X . Fix $a \in X$. Prove that the map $f : (X, \mathcal{T}) \rightarrow \mathbb{R}$ defined by $f(x) = d(a, x)$ is continuous.

6. Let (X, d) be a metric space and \mathcal{T} the topology induced on X by d . Let Y be a subset of X and d_1 the metric on Y obtained by restricting d ; that is, $d_1(a, b) = d(a, b)$ for all a and b in Y . If \mathcal{T}_1 is the topology induced on Y by d_1 and \mathcal{T}_2 is the subspace topology on Y (induced by \mathcal{T} on X), prove that $\mathcal{T}_1 = \mathcal{T}_2$. [This shows that **every subspace of a metrizable space is metrizable.**]

7. (i) Let ℓ_1 be the set of all sequences of real numbers

$$x = (x_1, x_2, \dots, x_n, \dots)$$

with the property that the series $\sum_{n=1}^{\infty} |x_n|$ is convergent. If we define

$$d_1(x, y) = \sum_{n=1}^{\infty} |x_n - y_n|$$

for all x and y in ℓ_1 , prove that (ℓ_1, d_1) is a metric space.

- (ii) Let ℓ_2 be the set of all sequences of real numbers

$$x = (x_1, x_2, \dots, x_n, \dots)$$

with the property that the series $\sum_{n=1}^{\infty} x_n^2$ is convergent. If we define

$$d_2(x, y) = \left(\sum_{n=1}^{\infty} |x_n - y_n|^2 \right)^{\frac{1}{2}}$$

for all x and y in ℓ_2 , prove that (ℓ_2, d_2) is a metric space.

- (iii) Let ℓ_{∞} denote the set of bounded sequences of real numbers

$x = (x_1, x_2, \dots, x_n, \dots)$. If we define

$$d_{\infty}(x, y) = \sup\{|x_n - y_n| : n \in \mathbb{N}\}$$

where $x, y \in \ell_{\infty}$, prove that $(\ell_{\infty}, d_{\infty})$ is a metric space.

- (iv) Let c_0 be the subset of ℓ_{∞} consisting of all those sequences which converge to zero and let d_0 be the metric on c_0 obtained by restricting the metric d_{∞} on ℓ_{∞} as in Exercise 6. Prove that c_0 is a closed subset of $(\ell_{\infty}, d_{\infty})$.

- (v) Prove that each of the spaces (ℓ_1, d_1) , (ℓ_2, d_2) , and (c_0, d_0) is a separable space.

- (vi)* Is $(\ell_{\infty}, d_{\infty})$ a separable space?

- (vii) Show that each of the above metric spaces is a normed vector space in a natural way.

8. Let f be a continuous mapping of a metrizable space (X, \mathcal{T}) onto a topological space (Y, \mathcal{T}_1) . Is (Y, \mathcal{T}_1) necessarily metrizable? (Justify your answer.)

Normal Spaces and T_4 -Spaces

9. A topological space (X, \mathcal{T}) is said to be a **normal space** if for each pair of disjoint closed sets A and B , there exist open sets U and V such that $A \subseteq U$, $B \subseteq V$, and $U \cap V = \emptyset$. Prove that
- (i) Every metrizable space is a normal space.
 - (ii) Every space which is both a T_1 -space and a normal space is a Hausdorff space. [A normal space which is also Hausdorff is called a **T_4 -space**.]

Isometry

10. Let (X, d) and (Y, d_1) be metric spaces. Then (X, d) is said to be **isometric** to (Y, d_1) if there exists a surjective mapping $f : (X, d) \rightarrow (Y, d_1)$ such that for all x_1 and x_2 in X ,

$$d(x_1, x_2) = d_1(f(x_1), f(x_2)).$$

Such a mapping f is said to be an **isometry**. Prove that every isometry is a homeomorphism of the corresponding topological spaces. (So **isometric metric spaces are homeomorphic!**)

First Axiom of Countability

11. A topological space (X, \mathcal{T}) is said to satisfy the **first axiom of countability** or be **first countable** if for each $x \in X$ there exists a countable family $\{U_i(x)\}$ of open sets containing x with the property that every open set V containing x has (at least) one of the $U_i(x)$ as a subset. The countable family $\{U_i(x)\}$ is said to be a **countable base** at x . Prove the following:
- (i) Every metrizable space satisfies the first axiom of countability.
 - (ii) Every topological space satisfying the second axiom of countability also satisfies the first axiom of countability.

12. Let X be the set $(\mathbb{R} \setminus \mathbb{N}) \cup \{1\}$. Define a function $f : \mathbb{R} \rightarrow X$ by

$$f(x) = \begin{cases} x, & \text{if } x \in \mathbb{R} \setminus \mathbb{N} \\ 1, & \text{if } x \in \mathbb{N}. \end{cases}$$

Further, define a topology \mathcal{T} on X by

$$\mathcal{T} = \{U : U \subseteq X \text{ and } f^{-1}(U) \text{ is open in the euclidean topology on } \mathbb{R}.\}$$

Prove the following:

- (i) f is continuous.
- (ii) Every open neighbourhood of 1 in (X, \mathcal{T}) is of the form $(U \setminus \mathbb{N}) \cup \{1\}$, where U is open in \mathbb{R} .
- (iii) (X, \mathcal{T}) is not first countable.

[Hint: Suppose $(U_1 \setminus \mathbb{N}) \cup \{1\}, (U_2 \setminus \mathbb{N}) \cup \{1\}, \dots, (U_n \setminus \mathbb{N}) \cup \{1\}, \dots$ is a countable base at 1. Show that for each positive integer n , we can choose $x_n \in U_n \setminus \mathbb{N}$ such that $x_n > n$. Verify that the set $U = \mathbb{R} \setminus \bigcup_{n=1}^{\infty} \{x_n\}$ is open in \mathbb{R} . Deduce that $V = (U \setminus \mathbb{N}) \cup \{1\}$ is an open neighbourhood of 1 which contains none of the sets $(U_n \setminus \mathbb{N}) \cup \{1\}$, which is a contradiction. So (X, \mathcal{T}) is not first countable.]

- (iv) (X, \mathcal{T}) is a Hausdorff space.
- (v) A Hausdorff continuous image of \mathbb{R} is not necessarily first countable.

Total Boundedness

13. A subset S of a metric space (X, d) is said to be **totally bounded** if for each $\varepsilon > 0$, there exist x_1, x_2, \dots, x_n in X , such that $S \subseteq \bigcup_{i=1}^n B_\varepsilon(x_i)$; that is, S can be covered by a finite number of open balls of radius ε .
- (i) Show that every totally bounded metric space is a bounded metric space. (See Exercise 2 above.)
- (ii) Prove that \mathbb{R} with the euclidean metric is not totally bounded, but for each $a, b \in \mathbb{R}$ with $a < b$, the closed interval $[a, b]$ is totally bounded.
- (iii) Let (Y, d) be a subspace of the metric space (X, d_1) with the induced metric. If (X, d_1) is totally bounded, then (Y, d) is totally bounded; that is, **every subspace of a totally bounded metric space is totally bounded**.
 [Hint: Assume $X = \bigcup_{i=1}^n B_\varepsilon(x_i)$. If $y_i \in B_\varepsilon(x_i) \cap Y$, then by the triangle inequality $B_\varepsilon(x_i) \subseteq B_{2\varepsilon}(y_i)$.]
- (iv) From (iii) and (ii) deduce that the totally bounded metric space $(0, 1)$ is homeomorphic to \mathbb{R} which is not totally bounded. Thus “totally bounded” is not a topological property.
- (v) From (i) deduce that, for each $n > 1$, \mathbb{R}^n with the euclidean metric is not totally bounded.
- (vi) Noting that for each $a, b \in \mathbb{R}$, the closed interval is totally bounded, show that a metric subspace of \mathbb{R} is bounded if and only if it is totally bounded.
- (vii) Show that for each $n > 1$, a metric subspace of \mathbb{R}^n is bounded if and only if it is totally bounded.
14. Show that every totally bounded metric space is separable. (See [Exercise 13 above](#) and [Exercises 3.2#4.](#))

Locally Euclidean Spaces and Topological Manifolds

15. A topological space (X, \mathcal{T}) is said to be **locally euclidean** if there exists a positive integer n such that each point $x \in X$ has an open neighbourhood homeomorphic to an open ball about 0 in \mathbb{R}^n with the euclidean metric. A Hausdorff locally euclidean space is said to be a **topological manifold**.¹
- (i) Prove that every non-trivial interval (a, b) , $a, b \in \mathbb{R}$, is locally euclidean.
 - (ii) Let \mathbf{S}^1 be the subspace of \mathbb{R}^2 consisting of all $x \in \mathbb{R}^2$ such that $d(x, 0) = 1$, where d is the Euclidean metric. Show that the space \mathbf{S}^1 is locally euclidean.
 - (iii) Show that every topological space locally homeomorphic to \mathbb{R}^n , for any positive integer n , is locally euclidean. (See [Exercises 4.3 #9](#).)
 - (iv)* Find an example of a locally euclidean space which is not a topological manifold.

¹There are different definitions of topological manifold in the literature (cf. Kunen and Vaughan [248]; Lee [254]). In particular some definitions require the space to be connected – what we call a **connected manifold** – and older definitions require the space to be metrizable. A Hausdorff space in which each point has an open neighbourhood homeomorphic either to \mathbb{R}^n or to the closed half-space $\{ \langle x_1, x_2, \dots, x_n \rangle : x_i \geq 0, i = 1, 2, \dots, n \}$ of \mathbb{R}^n , for some positive integer n , is said to be a **topological manifold with boundary**. There is a large literature on manifolds with more structure, especially **differentiable manifolds** (Gadea and Masque [147]; Barden and Thomas [33]), **smooth manifolds** (Lee [255]) and **Riemannian manifolds** or **Cauchy-Riemann manifolds** or **CR-manifolds**.

6.2 Convergence of Sequences

You are familiar with the notion of a convergent sequence of real numbers. It is defined as follows. The sequence $x_1, x_2, \dots, x_n, \dots$ of real numbers is said to **converge** to the real number x if given any $\varepsilon > 0$ there exists an integer n_0 such that for all $n \geq n_0$, $|x_n - x| < \varepsilon$.

It is obvious how this definition can be extended from \mathbb{R} with the euclidean metric to any metric space.

6.2.1 Definitions. Let (X, d) be a metric space and x_1, \dots, x_n, \dots a sequence of points in X . Then the sequence is said to **converge to** $x \in X$ if given any $\varepsilon > 0$ there exists an integer n_0 such that for all $n \geq n_0$, $d(x, x_n) < \varepsilon$.

This is denoted by $x_n \rightarrow x$.

The sequence $y_1, y_2, \dots, y_n, \dots$ of points in (X, d) is said to be **convergent** if there exists a point $y \in X$ such that $y_n \rightarrow y$.

The next Proposition is easily proved, so its proof is left as an exercise.

6.2.2 Proposition. Let $x_1, x_2, \dots, x_n, \dots$ be a sequence of points in a metric space (X, d) . Further, let x and y be points in (X, d) such that $x_n \rightarrow x$ and $x_n \rightarrow y$. Then $x = y$. \square

For convenience we say that a subset A of a metric space (X, d) is closed (respectively, open) in the metric space (X, d) if it is closed (respectively, open) in the topology \mathcal{T} induced on X by the metric d .

The following proposition tells us the surprising fact that the topology of a metric space can be described entirely in terms of its convergent sequences.

6.2.3 Proposition. Let (X, d) be a metric space. A subset A of X is closed in (X, d) if and only if every convergent sequence of points in A converges to a point in A . (In other words, A is closed in (X, d) if and only if $a_n \rightarrow x$, where $x \in X$ and $a_n \in A$ for all n , implies $x \in A$.)

Proof. Assume that A is closed in (X, d) and let $a_n \rightarrow x$, where $a_n \in A$ for all positive integers n . Suppose that $x \in X \setminus A$. Then, as $X \setminus A$ is an open set containing x , there exists an open ball $B_\varepsilon(x)$ such that $x \in B_\varepsilon(x) \subseteq X \setminus A$. Noting that each $a_n \in A$, this implies that $d(x, a_n) > \varepsilon$ for each n . Hence the sequence $a_1, a_2, \dots, a_n, \dots$ does not converge to x . This is a contradiction. So $x \in A$, as required.

Conversely, assume that every convergent sequence of points in A converges to a point of A . Suppose that $X \setminus A$ is not open. Then there exists a point $y \in X \setminus A$ such that for each $\varepsilon > 0$, $B_\varepsilon(y) \cap A \neq \emptyset$. For each positive integer n , let x_n be any point in $B_{1/n}(y) \cap A$. Then we claim that $x_n \rightarrow y$. To see this let ε be any positive real number, and n_0 any integer greater than $1/\varepsilon$. Then for each $n \geq n_0$,

$$x_n \in B_{1/n}(y) \subseteq B_{1/n_0}(y) \subseteq B_\varepsilon(y).$$

So $x_n \rightarrow y$ and, by our assumption, $y \in A$. This is a contradiction and so $X \setminus A$ is open and thus A is closed in (X, d) . □

Having seen that the topology of a metric space can be described in terms of convergent sequences, we should not be surprised that continuous functions can also be so described.

6.2.4 Proposition. Let (X, d) and (Y, d_1) be metric spaces and f a mapping of X into Y . Let \mathcal{T} and \mathcal{T}_1 be the topologies determined by d and d_1 , respectively. Then $f : (X, \mathcal{T}) \rightarrow (Y, \mathcal{T}_1)$ is continuous if and only if $x_n \rightarrow x \Rightarrow f(x_n) \rightarrow f(x)$; that is, if $x_1, x_2, \dots, x_n, \dots$ is a sequence of points in (X, d) converging to x , then the sequence of points $f(x_1), f(x_2), \dots, f(x_n), \dots$ in (Y, d_1) converges to $f(x)$.

Proof. Assume that $x_n \rightarrow x \Rightarrow f(x_n) \rightarrow f(x)$. To verify that f is continuous it suffices to show that the inverse image of every closed set in (Y, \mathcal{T}_1) is closed in (X, \mathcal{T}) . So let A be closed in (Y, \mathcal{T}_1) . Let $x_1, x_2, \dots, x_n, \dots$ be a sequence of points in $f^{-1}(A)$ convergent to a point $x \in X$. As $x_n \rightarrow x$, $f(x_n) \rightarrow f(x)$. But since each $f(x_n) \in A$ and A is closed, Proposition 6.2.3 then implies that $f(x) \in A$. Thus $x \in f^{-1}(A)$. So we have shown that every convergent sequence of points from $f^{-1}(A)$ converges to a point of $f^{-1}(A)$. Thus $f^{-1}(A)$ is closed, and hence f is continuous.

Conversely, let f be continuous and $x_n \rightarrow x$. Let ε be any positive real number. Then the open ball $B_\varepsilon(f(x))$ is an open set in (Y, \mathcal{T}_1) . As f is continuous, $f^{-1}(B_\varepsilon(f(x)))$ is an open set in (X, \mathcal{T}) and it contains x . Therefore there exists a $\delta > 0$ such that

$$x \in B_\delta(x) \subseteq f^{-1}(B_\varepsilon(f(x))).$$

As $x_n \rightarrow x$, there exists a positive integer n_0 such that for all $n \geq n_0$, $x_n \in B_\delta(x)$. Therefore

$$f(x_n) \in f(B_\delta(x)) \subseteq B_\varepsilon(f(x)), \text{ for all } n \geq n_0.$$

Thus $f(x_n) \rightarrow f(x)$. □

The Corollary below is easily deduced from [Proposition 6.2.4](#).

6.2.5 Corollary. Let (X, d) and (Y, d_1) be metric spaces, f a mapping of X into Y , and \mathcal{T} and \mathcal{T}_1 the topologies determined by d and d_1 , respectively. Then $f : (X, \mathcal{T}) \rightarrow (Y, \mathcal{T}_1)$ is continuous if and only if for each $x_0 \in X$ and $\varepsilon > 0$, there exists a $\delta > 0$ such that $x \in X$ and $d(x, x_0) < \delta \Rightarrow d_1(f(x), f(x_0)) < \varepsilon$. \square

In this section we have discussed the convergence of sequences in metric spaces. You might ask why we have not previously discussed the convergence of sequences in general topological spaces. In this context it would be helpful to watch the YouTube videos on [Sequences and Nets](#). These are called

“Topology Without Tears – Video 3a – Sequences and Nets” and

“Topology Without Tears – Video 3b – Sequences and Nets”

and can be found on YouTube at

<http://youtu.be/wXkNgyVg0JE> and <http://youtu.be/xNqLF8GsRFE>

and on the Chinese Youku site at

<http://tinyurl.com/kxdefsm> and <http://tinyurl.com/kbh93so>

or by following the relevant link from

<http://www.topologywithouttears.net>.

Exercises 6.2

- Let $C[0, 1]$ and d be as in [Example 6.1.5](#). Define a sequence of functions $f_1, f_2, \dots, f_n, \dots$ in $(C[0, 1], d)$ by

$$f_n(x) = \frac{\sin(nx)}{n}, \quad n = 1, 2, \dots, \quad x \in [0, 1].$$

Verify that $f_n \rightarrow f_0$, where $f_0(x) = 0$, for all $x \in [0, 1]$.

2. Let (X, d) be a metric space and $x_1, x_2, \dots, x_n, \dots$ a sequence such that $x_n \rightarrow x$ and $x_n \rightarrow y$. Prove that $x = y$.
3. (i) Let (X, d) be a metric space, \mathcal{T} the induced topology on X , and $x_1, x_2, \dots, x_n, \dots$ a sequence of points in X . Prove that $x_n \rightarrow x$ if and only if for every open set $U \ni x$, there exists a positive integer n_0 such that $x_n \in U$ for all $n \geq n_0$.
- (ii) Let X be a set and d and d_1 equivalent metrics on X . Deduce from (i) that if $x_n \rightarrow x$ in (X, d) , then $x_n \rightarrow x$ in (X, d_1) .
4. Write a proof of [Corollary 6.2.5](#).
5. Let (X, \mathcal{T}) be a topological space and let $x_1, x_2, \dots, x_n, \dots$ be a sequence of points in X . We say that $x_n \rightarrow x$ if for each open set $U \ni x$ there exists a positive integer n_0 , such that $x_n \in U$ for all $n \geq n_0$. Find an example of a topological space and a sequence such that $x_n \rightarrow x$ and $x_n \rightarrow y$ but $x \neq y$.
6. (i) Let (X, d) be a metric space and $x_n \rightarrow x$ where each $x_n \in X$ and $x \in X$. Let A be the subset of X which consists of x and all of the points x_n . Prove that A is closed in (X, d) .
- (ii) Deduce from (i) that the set $\{2\} \cup \{2 - \frac{1}{n} : n = 1, 2, \dots\}$ is closed in \mathbb{R} .
- (iii) Verify that the set $\{2 - \frac{1}{n} : n = 1, 2, \dots\}$ is not closed in \mathbb{R} .
7. (i) Let d_1, d_2, \dots, d_m be metrics on a set X and a_1, a_2, \dots, a_m positive real numbers. Prove that d is a metric on X , where d is defined by

$$d(x, y) = \sum_{i=1}^m a_i d_i(x, y), \text{ for all } x, y \in X.$$

- (ii) If $x \in X$ and $x_1, x_2, \dots, x_n, \dots$ is a sequence of points in X such that $x_n \rightarrow x$ in each metric space (X, d_i) prove that $x_n \rightarrow x$ in the metric space (X, d) .

8. Let X, Y, d_1, d_2 and d be as in [Exercises 6.1 #4](#). If $x_n \rightarrow x$ in (X, d_1) and $y_n \rightarrow y$ in (Y, d_2) , prove that

$$\langle x_n, y_n \rangle \rightarrow \langle x, y \rangle \text{ in } (X \times Y, d).$$

Distance between Two Sets

9. Let A and B be non-empty sets in a metric space (X, d) . Define

$$\rho(A, B) = \inf\{d(a, b) : a \in A, b \in B\}.$$

$[\rho(A, B)$ is referred to as the **distance between the sets A and B .**]

- (i) If S is any non-empty subset of (X, d) , prove that $\bar{S} = \{x : x \in X \text{ and } \rho(\{x\}, S) = 0\}$.
- (ii) If S is any non-empty subset of (X, d) prove that the function $f : (X, d) \rightarrow \mathbb{R}$ defined by

$$f(x) = \rho(\{x\}, S), \quad x \in X$$

is continuous.

10. (i) For each positive integer n let f_n be a continuous function of $[0, 1]$ into itself and let $a \in [0, 1]$ be such that $f_n(a) = a$, for all n . Further let f be a continuous function of $[0, 1]$ into itself. If $f_n \rightarrow f$ in $(C[0, 1], d^*)$ where d^* is the metric of [Example 6.1.6](#), prove that a is also a fixed point of f .
- (ii) Show that (i) would be false if d^* were replaced by the metric d , of [Example 6.1.5](#).

Sequentially Closed Sets, Sequential Spaces, and Frechet-Urysohn Spaces

- 11 (i) Let S be a subset of a topological space (X, \mathcal{T}) . Then S is said to be **sequentially closed** if for every $a \in X$ for which there exists $s_n \in S$, $n \in \mathbb{N}$, such that $s_n \rightarrow a$, the point $a \in S$; that is, if a sequence in S converges to a point a in X , then a is in S . (See [Exercise #5 above for convergence in a topological space](#).) A subset T of (X, \mathcal{T}) is said to be **sequentially open** if its complement $X \setminus T$ is sequentially closed. Prove that if (X, \mathcal{T}) is a metrizable space, then every sequentially closed set is closed and every sequentially open set is open.
- (ii)* Find an example of a (nonmetrizable) topological space in which not every sequentially closed subset is closed.
- (iii) A topological space (X, \mathcal{T}) is said to be a **sequential space** if every sequentially closed set is closed. Prove that a topological space is a sequential space if and only if every sequentially open set is open. Deduce from this

that if X is an uncountable set and \mathcal{T} is the countable-closed topology on X of [Exercises 1.1 #6](#), then (X, \mathcal{T}) is not a sequential space.

- (iv) Verify that **every metrizable space is a sequential space**. (See Engelking [131], Example 1.6.19 for an example of a sequential space which is not metrizable, indeed not a Frechet-Urysohn space which is defined in (vi) below.)
- (v) Prove that **every open subspace and every closed subspace of a sequential space is a sequential space**. (See Engelking [131], Examples 1.6.19 and 1.6.20 for examples of a subspace of a sequential space which is not a sequential space. This is in contrast with (vii) below.)
- (vi) A topological space (X, \mathcal{T}) is said to be a **Frechet-Urysohn space** (or a **Frechet space**) if for every subset S of (X, \mathcal{T}) and every a in the closure, \overline{S} , of S there is a sequence $s_n \rightarrow a$, for $s_n \in S$, $n \in \mathbb{N}$. Prove that every first countable space (and hence also every metrizable space) is a Frechet-Urysohn space and every Frechet-Urysohn space is a sequential space. (See [Exercises 6.1 #11](#) for the definition of a first countable space.) (See [Exercises 11.2 #6](#) for an example of a sequential space which is not first countable and Engelking [131], Example 1.4.17 for an example of a Frechet-Urysohn space which is not first countable.)
- (vii) Prove that **every subspace of a Frechet-Urysohn space is a Frechet-Urysohn space and hence also a sequential space**.
- (vii)* Provide the appropriate definition of a function $f : (X, \mathcal{T}) \rightarrow (Y, \mathcal{T}_1)$ between two topological spaces being **sequentially continuous**. Show that if (X, \mathcal{T}) and (Y, \mathcal{T}_1) are metrizable spaces, then every sequentially continuous map between them is continuous.

Countable Tightness

- 12 A topological space (X, \mathcal{T}) is said to have **countable tightness** if for each subset S of X and each $x \in \overline{S}$, there exists a countable set $C \subseteq S$, such that $x \in \overline{C}$. Prove that if (X, \mathcal{T}) is a sequential space, then it has countable tightness.

13. Using the above exercises verify the implications and picture below:

metrizable \Rightarrow first countable \Rightarrow Frechet-Urysohn \Rightarrow sequential \Rightarrow countable tightness

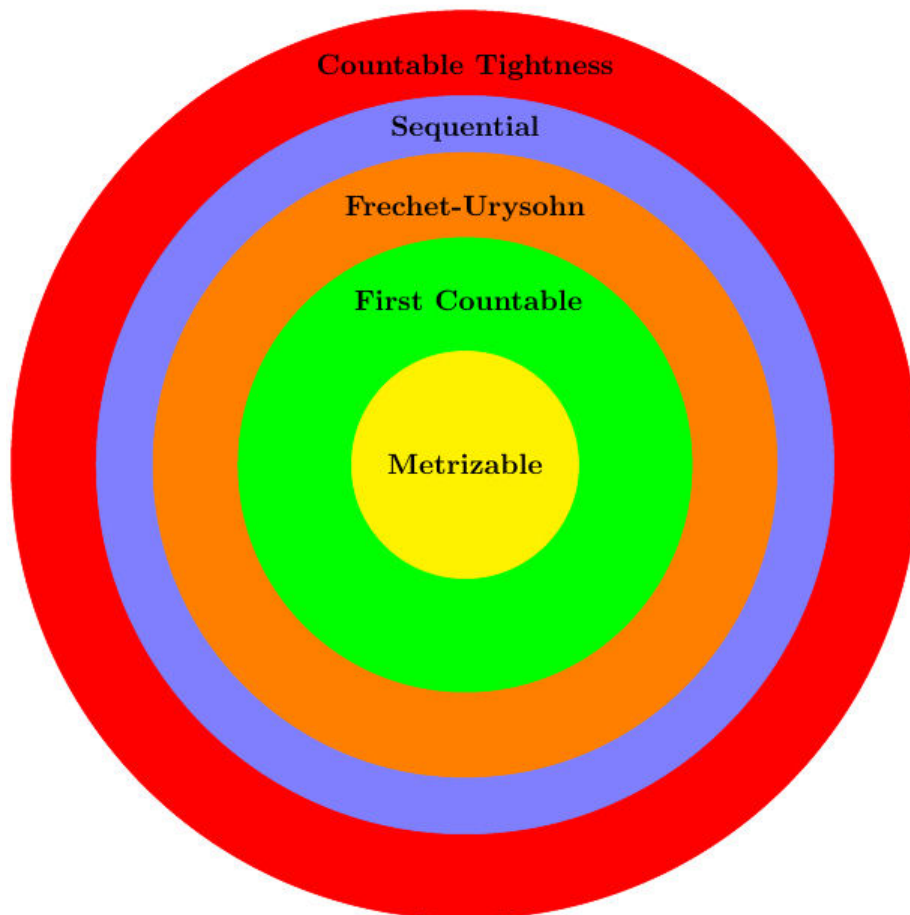

6.3 Completeness

6.3.1 Definition. A sequence $x_1, x_2, \dots, x_n, \dots$ of points in a metric space (X, d) is said to be a **Cauchy sequence** if given any real number $\varepsilon > 0$, there exists a positive integer n_0 , such that for all integers $m \geq n_0$ and $n \geq n_0$, $d(x_m, x_n) < \varepsilon$.

6.3.2 Proposition. Let (X, d) be a metric space and $x_1, x_2, \dots, x_n, \dots$ a sequence of points in (X, d) . If there exists a point $a \in X$, such that the sequence converges to a , that is, $x_n \rightarrow a$, then the sequence is a Cauchy sequence.

Proof. Let ε be any positive real number. Put $\delta = \varepsilon/2$. As $x_n \rightarrow a$, there exists a positive integer n_0 , such that for all $n > n_0$, $d(x_n, a) < \delta$.

So let $m > n_0$ and $n > n_0$. Then $d(x_n, a) < \delta$ and $d(x_m, a) < \delta$.

By the triangle inequality for metrics,

$$\begin{aligned} d(x_m, x_n) &\leq d(x_m, a) + d(x_n, a) \\ &< \delta + \delta \\ &= \varepsilon \end{aligned}$$

and so the sequence is indeed a Cauchy sequence. \square

This naturally leads us to think about the converse statement and to ask if every Cauchy sequence is a convergent sequence. The following example shows that this is not true.

6.3.3 Example. Consider the open interval $(0, 1)$ with the euclidean metric d . It is clear that the sequence $0.1, 0.01, 0.001, 0.0001, \dots$ is a Cauchy sequence but it does not converge to any point in $(0, 1)$. \square

6.3.4 Definition. A metric space (X, d) is said to be **complete** if every Cauchy sequence in (X, d) converges to a point in (X, d) .

We immediately see from [Example 6.3.3](#) that the unit interval $(0,1)$ with the euclidean metric is not a complete metric space. On the other hand, if X is any finite set and d is the discrete metric on X , then obviously (X, d) is a complete metric space.

We shall show that \mathbb{R} with the euclidean metric is a complete metric space. First we need to do some preparation.

As a shorthand, we shall denote the sequence $x_1, x_2, \dots, x_n, \dots$, by $\{x_n\}$.

6.3.5 Definition. If $\{x_n\}$ is any sequence, then the sequence x_{n_1}, x_{n_2}, \dots is said to be a **subsequence** if $n_1 < n_2 < n_3 < \dots$.

6.3.6 Definitions. Let $\{x_n\}$ be a sequence in \mathbb{R} . Then it is said to be an **increasing sequence** if $x_n \leq x_{n+1}$, for all $n \in \mathbb{N}$. It is said to be a **decreasing sequence** if $x_n \geq x_{n+1}$, for all $n \in \mathbb{N}$. A sequence which is either increasing or decreasing is said to be **monotonic**.

Most sequences are of course neither increasing nor decreasing.

6.3.7 Definition. Let $\{x_n\}$ be a sequence in \mathbb{R} . Then $n_0 \in \mathbb{N}$ is said to be a **peak point** if $x_n \leq x_{n_0}$, for every $n \geq n_0$.

6.3.8 Lemma. Let $\{x_n\}$ be any sequence in \mathbb{R} . Then $\{x_n\}$ has a monotonic subsequence.

Proof. Assume firstly that the sequence $\{x_n\}$ has an infinite number of peak points. Then choose a subsequence $\{x_{n_k}\}$, where each n_k is a peak point. This implies, in particular, that $x_{n_k} \geq x_{n_{k+1}}$, for each $k \in \mathbb{N}$; that is, $\{x_{n_k}\}$ is a decreasing subsequence of $\{x_n\}$; so it is a monotonic subsequence.

Assume then that there are only a finite number of peak points. So there exists an integer N , such that there are no peak points $n > N$. Choose any $n_1 > N$. Then n_1 is not a peak point. So there is an $n_2 > n_1$ with $x_{n_2} > x_{n_1}$. Now $n_2 > N$ and so it too is not a peak point. Hence there is an $n_3 > n_2$, with $x_{n_3} > x_{n_2}$. Continuing in this way (by mathematical induction), we produce a subsequence $\{x_{n_k}\}$ of $\{x_n\}$ with $x_{n_k} < x_{n_{k+1}}$, for all $k \in \mathbb{N}$; that is, $\{x_{n_k}\}$ is an increasing subsequence of $\{x_n\}$. This completes the proof of the Lemma. \square

6.3.9 Proposition. Let $\{x_n\}$ be a monotonic sequence in \mathbb{R} with the euclidean metric. Then $\{x_n\}$ converges to a point in \mathbb{R} if and only if $\{x_n\}$ is bounded.

Proof. Recall that “bounded” was defined in [Remark 3.3.1](#).

Clearly if $\{x_n\}$ is unbounded, then it does not converge.

Assume then that $\{x_n\}$ is an increasing sequence which is bounded. By the Least Upper Bound Axiom, there is a least upper bound L of the set $\{x_n : n \in \mathbb{N}\}$. If ε is any positive real number, then there exists a positive integer N such that $d(x_N, L) < \varepsilon$; indeed, $x_N > L - \varepsilon$.

But as $\{x_n\}$ is an increasing sequence and L is an upper bound, we have

$$L - \varepsilon < x_n < L, \quad \text{for all } n > N.$$

That is $x_n \rightarrow L$.

The case that $\{x_n\}$ is a decreasing sequence which is bounded is proved in an analogous fashion, which completes the proof. \square

As a corollary to [Lemma 6.3.8](#) and [Proposition 6.3.9](#), we obtain immediately the following:

6.3.10 Theorem. (Bolzano-Weierstrass Theorem) Every bounded sequence in \mathbb{R} with the euclidean metric has a convergent subsequence. \square

At long last we are able to prove that \mathbb{R} with the euclidean metric is a complete metric space.

6.3.11 Corollary. The metric space \mathbb{R} with the euclidean metric is a complete metric space.

Proof. Let $\{x_n\}$ be any Cauchy sequence in (\mathbb{R}, d) .

If we show that this arbitrary Cauchy sequence converges in \mathbb{R} , we shall have shown that the metric space is complete. The first step will be to show that this sequence is bounded.

As $\{x_n\}$ is a Cauchy sequence, there exists a positive integer N , such that for any $n \geq N$ and $m \geq N$, $d(x_n, x_m) < 1$; that is, $|x_n - x_m| < 1$. Put $M = |x_1| + |x_2| + \cdots + |x_N| + 1$. Then $|x_n| < M$, for all $n \in \mathbb{N}$; that is, the sequence $\{x_n\}$ is bounded.

So by the [Bolzano-Weierstrass Theorem 6.3.10](#), this sequence has a convergent subsequence; that is, there is an $a \in \mathbb{R}$ and a subsequence $\{x_{n_k}\}$ with $x_{n_k} \rightarrow a$.

We shall show that not only does the subsequence converge to a , but also that the sequence $\{x_n\}$ itself converges to a .

Let ε be any positive real number. As $\{x_n\}$ is a Cauchy sequence, there exists a positive integer N_0 such that

$$|x_n - x_m| < \frac{\varepsilon}{2}, \quad \text{for all } m \geq N_0 \text{ and } n \geq N_0.$$

Since $x_{n_k} \rightarrow a$, there exists a positive integer N_1 , such that

$$|x_{n_k} - a| < \frac{\varepsilon}{2}, \quad \text{for all } n_k \geq N_1.$$

So if we choose $N_2 = \max\{N_0, N_1\}$, combining the above two inequalities yields

$$\begin{aligned} |x_n - a| &\leq |x_n - x_{n_k}| + |x_{n_k} - a| \\ &< \frac{\varepsilon}{2} + \frac{\varepsilon}{2}, \quad \text{for } n > N_2 \text{ and } n_k > N_2 \\ &= \varepsilon. \end{aligned}$$

Hence $x_n \rightarrow a$, which completes the proof of the Corollary. \square

6.3.12 Corollary. For each positive integer m , the metric space \mathbb{R}^m with the euclidean metric is a complete metric space.

Proof. See [Exercises 6.3 #4](#). \square

6.3.13 Proposition. Let (X, d) be a metric space, Y a subset of X , and d_1 the metric induced on Y by d .

- (i) If (X, d) is a complete metric space and Y is a closed subspace of (X, d) , then (Y, d_1) is a complete metric space.
- (ii) If (Y, d_1) is a complete metric space, then Y is a closed subspace of (X, d) .

Proof. See [Exercises 6.3 #5](#). \square

6.3.14 Remark. Note that [Example 6.3.3](#) showed that $(0, 1)$ with the euclidean metric is not a complete metric space. However, [Corollary 6.3.11](#) showed that \mathbb{R} with the euclidean metric is a complete metric space. And we know that the topological spaces $(0, 1)$ and \mathbb{R} are homeomorphic. So **completeness is not preserved by homeomorphism and so is not a topological property.**

6.3.15 Definition. A topological space (X, \mathcal{T}) is said to be **completely metrizable** if there exists a metric d on X such that \mathcal{T} is the topology on X determined by d and (X, d) is a complete metric space.

6.3.16 Remark. Note that being completely metrizable is indeed a topological property. Further, it is easy to verify (see [Exercises 6.3 #7](#)) that every discrete space and every interval of \mathbb{R} with the induced topology is completely metrizable. So for $a, b \in \mathbb{R}$ with $a < b$, the topological spaces \mathbb{R} , $[a, b]$, (a, b) , $[a, b)$, $(a, b]$, $(-\infty, a)$, $(-\infty, a]$, (a, ∞) , $[a, \infty)$, and $\{a\}$ with their induced topologies are all

completely metrizable. Somewhat surprisingly we shall see later that even the space \mathbb{P} of all irrational numbers with its induced topology is completely metrizable. Also as $(0, 1)$ is a completely metrizable subspace of \mathbb{R} which is not a closed subset, we see that [Proposition 6.3.13\(ii\)](#) would not be true if complete metric were replaced by completely metrizable. \square

6.3.17 Definition. A topological space is said to be **separable** if it has a countable dense subset.

It was seen in [Exercises 3.2 #4](#) that \mathbb{R} and every countable topological space is a separable space. Other examples are given in [Exercises 6.1 #7](#).

6.3.18 Definition. A topological space (X, \mathcal{T}) is said to be a **Polish space** if it is separable and completely metrizable.

It is clear that \mathbb{R} is a Polish space. By [Exercises 6.3 #6](#), \mathbb{R}^n is a Polish space, for each positive integer n .

6.3.19 Definition. A topological space (X, \mathcal{T}) is said to be a **Souslin space** (or **Suslin space**) if it is Hausdorff and a continuous image of a Polish space. If A is a subset of a topological space (Y, \mathcal{T}_1) such that with the induced topology \mathcal{T}_2 , the space (A, \mathcal{T}_2) is a Souslin space, then A is said to be an **analytic set** in (Y, \mathcal{T}_1) .

Obviously every Polish space is a Souslin² space. [Exercises 6.1 #12](#) and [#11](#) show that the converse is false as a Souslin space need not be metrizable. However, we shall see that even a metrizable Souslin space is not necessarily a Polish space. To see this we note that **every countable topological space is a Souslin space** as it is a continuous image of the discrete space \mathbb{N} ; one such space is the metrizable space \mathbb{Q} which we shall see in [Example 6.5.8](#) is not a Polish space.

²Souslin is sometimes transliterated from Russian as Suslin. Andrei Suslin (1950–) proved Serre's "conjecture" on algebraic vector bundles, as did Daniel Quillen (1940–2011). Jean-Pierre Serre (1926–) mentioned this problem in a paper in 1955.

We know that two topological spaces are equivalent if they are homeomorphic. It is natural to ask when are two metric spaces equivalent (as metric spaces)? The relevant concept was introduced in [Exercises 6.1 #10](#), namely that of isometric.

6.3.20 Definition. Let (X, d) and (Y, d_1) be metric spaces. Then (X, d) is said to be **isometric** to (Y, d_1) if there exists a surjective mapping $f : X \rightarrow Y$ such that for all x_1 and x_2 in X , $d(x_1, x_2) = d_1(f(x_1), f(x_2))$. Such a mapping f is said to be an **isometry**.

Let d be any metric on \mathbb{R} and a any positive real number. If d_1 is defined by $d_1(x, y) = a \cdot d(x, y)$, for all $x, y \in \mathbb{R}$, then it is easily shown that (\mathbb{R}, d_1) is a metric space isometric to (\mathbb{R}, d) .

It is also easy to verify that any two isometric metric spaces have their associated topological spaces homeomorphic and every isometry is also a homeomorphism of the associated topological spaces.

6.3.21 Definition. Let (X, d) and (Y, d_1) be metric spaces and f a mapping of X into Y . Let $Z = f(X)$, and d_2 be the metric induced on Z by d_1 . If $f : (X, d) \rightarrow (Z, d_2)$ is an isometry, then f is said to be an **isometric embedding** of (X, d) in (Y, d_1) .

Of course the natural embedding of \mathbb{Q} with the euclidean metric in \mathbb{R} with the euclidean metric is an isometric embedding. It is also the case that \mathbb{N} with the euclidean metric has a natural isometric embedding into both \mathbb{R} and \mathbb{Q} with the euclidean metric.

6.3.22 Definition. Let (X, d) and (Y, d_1) be metric spaces and f a mapping of X into Y . If (Y, d_1) is a complete metric space, $f : (X, d) \rightarrow (Y, d_1)$ is an isometric embedding and $f(X)$ is a dense subset of Y in the associated topological space, then (Y, d_1) is said to be a **completion** of (X, d) .

Clearly \mathbb{R} with the euclidean metric is a completion of \mathbb{Q} , the set of rationals with the euclidean metric. Also \mathbb{R} with the euclidean metric is a completion of \mathbb{I} ,

the set of irrationals with the euclidean metric. Two questions immediately jump to mind: (1) Does every metric space have a completion? (2) Is the completion of a metric space unique in some sense? We shall see that the answer to both questions is “yes”.

6.3.23 Proposition. If (X, d) is a metric space, then it has a completion.

Outline Proof. We begin by saying that two Cauchy sequences $\{y_n\}$ and $\{z_n\}$ in (X, d) are equivalent if $d(y_n, z_n) \rightarrow 0$ in \mathbb{R} . This is indeed an equivalence relation; that is, it is reflexive, symmetric and transitive. Now let \tilde{X} be the set of all equivalence classes of equivalent Cauchy sequences in (X, d) . We wish to put a metric on \tilde{X} .

Let \tilde{y} and \tilde{z} be any two points in \tilde{X} . Let Cauchy sequences $\{y_n\} \in \tilde{y}$ and $\{z_n\} \in \tilde{z}$. Now the sequence $\{d(y_n, z_n)\}$ is a Cauchy sequence in \mathbb{R} . (See [Exercises 6.3 #8.](#)) As \mathbb{R} is a complete metric space, this Cauchy sequence in \mathbb{R} converges to some number, which we shall denote by $d_1(\tilde{y}, \tilde{z})$. It is straightforward to show that $d_1(\tilde{y}, \tilde{z})$ is not dependent on the choice of the sequence $\{y_n\}$ in \tilde{y} and $\{z_n\}$ in \tilde{z} .

For each $x \in X$, the constant sequence x, x, \dots, x, \dots is a Cauchy sequence in (X, d) converging to x . Let \tilde{x} denote the equivalence class of all Cauchy sequences converging to $x \in X$. Define the subset Y of \tilde{X} to be $\{\tilde{x} : x \in X\}$. If d_2 is the metric on Y induced by the metric d_1 on \tilde{X} , then it is clear that the mapping $f : (X, d) \rightarrow (Y, d_2)$, given by $f(x) = \tilde{x}$, is an isometry.

Now we show that Y is dense in \tilde{X} . To do this we show that for any given real number $\varepsilon > 0$, and $z \in \tilde{X}$, there is an $\tilde{x} \in Y$, such that $d_1(z, \tilde{x}) < \varepsilon$. Note that z is an equivalence class of Cauchy sequences. Let $\{x_n\}$ be a Cauchy sequence in this equivalence class z . There exists a positive integer n_0 , such that for all $n > n_0$, $d_1(x_n, x_{n_0}) < \varepsilon$. We now consider the constant sequence $x_{n_0}, x_{n_0}, \dots, x_{n_0}, \dots$. This lies in the equivalence class \tilde{x}_{n_0} , which is in Y . Further, $d_1(\tilde{x}_{n_0}, z) < \varepsilon$. So Y is indeed dense in \tilde{X} .

Finally, we show that (\tilde{X}, d_1) is a complete metric space. Let $\{z_n\}$ be a Cauchy sequence in this space. We are required to show that it converges in \tilde{X} . As Y is dense, for each positive integer n , there exists $\tilde{x}_n \in Y$, such that $d_1(\tilde{x}_n, z_n) < 1/n$. We show that $\{\tilde{x}_n\}$ is a Cauchy sequence in Y .

Consider a real number $\varepsilon > 0$. There exists a positive integer N , such that $d_1(z_n, z_m) < \varepsilon/2$ for $n, m > N$. Now take a positive integer n_1 , with $1/n_1 < \varepsilon/4$. For $n, m > n_1 + N$, we have

$$d_1(\tilde{x}_n, \tilde{x}_m) < d_1(\tilde{x}_n, z_n) + d_1(z_n, z_m) + d_1(z_m, \tilde{x}_m) < 1/n + \varepsilon/2 + 1/m < \varepsilon.$$

So $\{\tilde{x}_n\}$ is a Cauchy sequence in Y . This implies that $\{x_n\}$ is a Cauchy sequence in (X, d) . Hence $\{x_n\} \in z$, for some $z \in \tilde{X}$. It is now straightforward to show first that $\tilde{x}_n \rightarrow z$ and then that $z_n \rightarrow z$, which completes the proof. \square

6.3.24 Proposition. Let (A, d_1) and (B, d_2) be complete metric spaces. Let X be a subset of (A, d_1) with induced metric d_3 , and Y a subset of (B, d_2) with induced metric d_4 . Further, let X be dense in (A, d_1) and Y dense in (B, d_2) . If there is an isometry $f : (X, d_3) \rightarrow (Y, d_4)$, then there exists an isometry $g : (A, d_1) \rightarrow (B, d_2)$, such that $g(x) = f(x)$, for all $x \in X$.

Outline Proof. Let $a \in A$. As X is dense in (A, d_1) , there exists a sequence $x_n \rightarrow a$, where each $x_n \in X$. So $\{x_n\}$ is a Cauchy sequence. As f is an isometry, $\{f(x_n)\}$ is a Cauchy sequence in (Y, d_4) and hence also a Cauchy sequence in (B, d_2) . Since (B, d_2) is a complete metric space, there exists a $b \in B$, such that $f(x_n) \rightarrow b$. So we define $g(a) = b$.

To show that g is a well-defined map of A into B , it is necessary to verify that if $\{z_n\}$ is any other sequence in X converging to a , then $f(z_n) \rightarrow b$. This follows from the fact that $d_1(x_n, z_n) \rightarrow 0$ and thus $d_2(f(x_n), f(z_n)) = d_4(f(x_n), f(z_n)) \rightarrow 0$.

Next we need to show that $g : A \rightarrow B$ is one-to-one and onto. This is left as an exercise as it is routine.

Finally, let $a_1, a_2 \in A$ and $a_{1n} \rightarrow a_1$ and $a_{2n} \rightarrow a_2$, where each a_{1n} and each a_{2n} is in X . Then

$$d_1(a_1, a_2) = \lim_{n \rightarrow \infty} d_3(a_{1n}, a_{2n}) = \lim_{n \rightarrow \infty} d_4(f(a_{1n}), f(a_{2n})) = d_2(g(a_1), g(a_2))$$

and so g is indeed an isometry, as required. \square

[Proposition 6.3.24](#) says that, up to isometry, the completion of a metric spaces is unique.

We conclude this section with another concept. Recall that in [Example 6.1.9](#) we introduced the concept of a normed vector space. We now define a very important class of normed vector spaces.

6.3.25 Definition. Let $(N, \| \cdot \|)$ be a normed vector space and d the associated metric on the set N . Then $(N, \| \cdot \|)$ is said to be a **Banach space** if (N, d) is a complete metric space.

6.3.26 Example. In Exercises 6.1 #7 and #8 we introduced the metric spaces (ℓ_1, d_1) , (ℓ_2, d_2) , (ℓ_∞, d_∞) , and (c_0, d_0) and recorded that each can be made into a normed vector space in a natural way. We use the notation ℓ_1 , ℓ_∞ , ℓ_2 and c_0 to denote these normed spaces. Indeed each of these is a Banach space, and ℓ_1 , ℓ_2 , and c_0 are separable Banach spaces. (See Exercises 6.3 #11.) \square

From Proposition 6.3.23 we know that every normed vector space has a completion. However, the rather pleasant feature is that this completion is in fact also a normed vector space and so is a Banach space. (See Exercises 6.3 #12.)

Exercises 6.3

1. Verify that the sequence $\{x_n = \sum_{i=0}^n \frac{1}{i!}\}$ is a Cauchy sequence in \mathbb{Q} with the euclidean metric. [This sequence does not converge in \mathbb{Q} . In \mathbb{R} it converges to the number e , which is known to be irrational. For a proof that e is irrational, indeed transcendental, see Jones et al. [221].]
2. Prove that every subsequence of a Cauchy sequence is a Cauchy sequence.
3. Give an example of a sequence in \mathbb{R} with the euclidean metric which has no subsequence which is a Cauchy sequence.
4. Using Corollary 6.3.11, prove that, for each positive integer m , the metric space \mathbb{R}^m with the euclidean metric is a complete metric space.
[Hint: Let $\{< x_{1n}, x_{2n}, \dots, x_{mn} > : n = 1, 2, \dots\}$ be a Cauchy sequence in \mathbb{R}^m . Prove that, for each $i = 1, 2, \dots, m$, the sequence $\{x_{in} : n = 1, 2, \dots\}$ in \mathbb{R} with the euclidean metric is a Cauchy sequence and so converges to a point a_i . Then show that the sequence $\{< x_{1n}, x_{2n}, \dots, x_{mn} > : n = 1, 2, \dots\}$ converges to the point $< a_1, a_2, \dots, a_m >$.]
5. Prove that **every closed subspace of a complete metric space is complete** and that **every complete metric subspace of a metric space is closed**.
6. Prove that for each positive integer n , \mathbb{R}^n is a Polish space.

7. Let $a, b \in \mathbb{R}$, with $a < b$. Prove that each discrete subspace of \mathbb{R} and each of the spaces $[a, b]$, (a, b) , $[a, b)$, $(a, b]$, $(-\infty, a)$, $(-\infty, a]$, (a, ∞) , $[a, \infty)$, and $\{a\}$, with the topology induced as a subspace of \mathbb{R} , is a Polish Space.
8. If (X, d) is a metric space and $\{x_n\}$ and $\{y_n\}$ are Cauchy sequences, prove that $\{d(x_n, y_n)\}$ is a Cauchy sequence in \mathbb{R} .
9. Fill in the missing details in the proof of [Proposition 6.3.23](#).
10. Fill in the missing details in the proof of [Proposition 6.3.24](#).
- 11*. Show that each of the spaces (ℓ_1, d_1) , (ℓ_2, d_2) , (c_0, d_0) , and (ℓ_∞, d_∞) of [Exercises 6.1 #7](#) is a complete metric space. Indeed, show that each of these spaces is a Banach space in a natural way.
- 12*. Let X be any normed vector space. Prove that it is possible to put a normed vector space structure on \tilde{X} , the complete metric space constructed in [Proposition 6.3.23](#). So **every normed vector space has a completion which is a Banach space**.
13. Let (X, d) be a metric space and S a subset of X . Then the set S is said to be **bounded** if there exists a positive integer M such that $d(x, y) < M$, for all $x, y \in S$.
 - (i) Show that if S is a bounded set in (X, d) and $S = X$, then (X, d) is a bounded metric space. (See [Exercises 6.1 # 2](#).)
 - (ii) Let $a_1, a_2, \dots, a_n, \dots$ be a convergent sequence in a metric space (X, d) . If the set S consists of the (distinct) points in this sequence, show that S is a bounded set.
 - (iii) Let $b_1, b_2, \dots, b_n, \dots$ be a Cauchy sequence in a complete metric space (X, d) . If T is the set of points in this sequence, show that T is a bounded set.
 - (iv) Is (iii) above still true if we do not insist that (X, d) is complete?
14. Prove that a metric space (X, d) is separable if and only if the associated topological space (X, \mathcal{T}) satisfies the second axiom of countability. (See [Exercises 2.2 #4](#).)

15. Deduce from [Exercise 14 above](#) that if (X, d) is a separable metric space, and d_1 is the metric induced on a subset Y of X by d , then (Y, d_1) is separable; in other words **every subspace of a separable metric space is separable**. (It should be noted that it is not necessarily true that a subspace of a separable topological space is separable.)

6.4 Contraction Mappings

In [Chapter 5](#) we had our first glimpse of a fixed point theorem. In this section we shall meet another type of fixed point theorem. This section is very much part of metric space theory rather than general topology. Nevertheless the topic is important for applications.

6.4.1 Definition. Let f be a mapping of a set X into itself. Then a point $x \in X$ is said to be a **fixed point** of f if $f(x) = x$.

6.4.2 Definition. Let (X, d) be a metric space and f a mapping of X into itself. Then f is said to be a **contraction mapping** if there exists an $r \in (0, 1)$, such that

$$d(f(x_1), f(x_2)) \leq r \cdot d(x_1, x_2), \quad \text{for all } x_1, x_2 \in X.$$

6.4.3 Proposition. Let f be a contraction mapping of the metric space (X, d) . Then f is a continuous mapping.

Proof. See [Exercises 6.4 #1](#).

□

6.4.4 Theorem. (Contraction Mapping Theorem or Banach Fixed Point Theorem) Let (X, d) be a complete metric space and f a contraction mapping of (X, d) into itself. Then f has precisely one fixed point.

Proof. Let x be any point in X and consider the sequence

$$x, f(x), f^2(x) = f(f(x)), f^3(x) = f(f(f(x))), \dots, f^n(x), \dots$$

We shall show this is a Cauchy sequence. Put $a = d(x, f(x))$. As f is a contraction mapping, there exists $r \in (0, 1)$, such that $d(f(x_1), f(x_2)) \leq r \cdot d(x_1, x_2)$, for all $x_1, x_2 \in X$.

Clearly $d(f(x), f^2(x)) \leq r \cdot d(x, f(x)) = r \cdot a$, $d(f^2(x), f^3(x)) \leq r^2 \cdot d(x, f(x)) = r^2 \cdot a$, and by induction we obtain that, for each $k \in \mathbb{N}$, $d(f^k(x), f^{k+1}(x)) \leq r^k \cdot d(x, f(x)) = r^k \cdot a$.

Let m and n be any positive integers, with $n > m$. Then

$$\begin{aligned} d(f^m(x), f^n(x)) &= d(f^m(x), f^m(f^{n-m}(x))) \\ &\leq r^m \cdot d(x, f^{n-m}(x)) \\ &\leq r^m \cdot [d(x, f(x)) + d(f(x), f^2(x)) + \dots + d(f^{n-m-1}(x), f^{n-m}(x))] \\ &\leq r^m \cdot d(x, f(x)) [1 + r + r^2 + \dots + r^{n-m-1}] \\ &\leq \frac{r^m \cdot a}{1 - r}. \end{aligned}$$

As $r < 1$, it is clear that $\{f^n(x)\}$ is a Cauchy sequence. Since (X, d) is complete, there is a $z \in X$, such that $f^n(x) \rightarrow z$.

By [Proposition 6.4.3](#), f is continuous and so

$$f(z) = f\left(\lim_{n \rightarrow \infty} f^n(x)\right) = \lim_{n \rightarrow \infty} f^{n+1}(x) = z \quad (6.1)$$

and so z is indeed a fixed point of f .

Finally, let t be any fixed point of f . Then

$$d(t, z) = d(f(t), f(z)) \leq r \cdot d(t, z). \quad (6.2)$$

As $r < 1$, this implies $d(t, z) = 0$ and thus $t = z$ and f has only one fixed point. \square

It is worth mentioning that the Contraction Mapping Theorem provides not only an existence proof of a fixed point but also a construction for finding it; namely, let x be any point in X and find the limit of the sequence $\{f^n(x)\}$. This method allows us to write a computer program to approximate the limit point to any desired accuracy.

Exercises 6.4

1. Prove [Proposition 6.4.3](#).
2. Extend the [Contraction Mapping Theorem 6.4.4](#) by showing that if f is a mapping of a complete metric space (X, d) into itself and f^N is a contraction mapping for some positive integer N , then f has precisely one fixed point.

Mean Value Theorem

3. The **Mean Value Theorem** says: **Let f be a real-valued function on a closed unit interval $[a, b]$ which is continuous on $[a, b]$ and differentiable on (a, b) . Then there exists a point $c \in [a, b]$ such that $f(b) - f(a) = f'(c)(b - a)$.** (Recall that f is said to be **differentiable** at a point s if $\lim_{x \rightarrow s} \frac{f(x) - f(s)}{x - s} = f'(s)$ exists.)

Using the Mean Value Theorem prove the following:

Let $f : [a, b] \rightarrow [a, b]$ be differentiable. Then f is a contraction if and only if there exists $r \in (0, 1)$ such that $|f'(x)| \leq r$, for all $x \in [a, b]$.

4. Using [Exercises 3](#) and [2 above](#), show that while $f : \mathbb{R} \rightarrow \mathbb{R}$ given by $f(x) = \cos x$ does not satisfy the conditions of the Contraction Mapping Theorem, it nevertheless has a unique fixed point.

6.5 Baire Spaces

6.5.1 Theorem. (Baire Category Theorem) Let (X, d) be a complete metric space. If $X_1, X_2, \dots, X_n, \dots$ is a sequence of open dense subsets of X , then the set $\bigcap_{n=1}^{\infty} X_n$ is also dense in X .

Proof. It suffices to show that if U is any non-empty open subset of (X, d) , then $U \cap \bigcap_{n=1}^{\infty} X_n \neq \emptyset$.

As X_1 is open and dense in X , the set $U \cap X_1$ is a non-empty open subset of (X, d) . Let U_1 be an open ball of radius at most 1, such that $\overline{U_1} \subset U \cap X_1$.

Inductively define for each positive integer $n > 1$, an open ball U_n of radius at most $1/n$ such that $\overline{U_n} \subset U_{n-1} \cap X_n$.

For each positive integer n , let x_n be any point in U_n . Clearly the sequence $\{x_n\}$ is a Cauchy sequence. As (X, d) is a complete metric space, this sequence converges to a point $x \in X$.

Observe that for every positive integer m and each $n > m$, the point x_n is in the closed set $\overline{U_m}$, and so the limit point x is also in the set $\overline{U_m}$.

Then $x \in \overline{U_n}$, for all $n \in \mathbb{N}$. Thus $x \in \bigcap_{n=1}^{\infty} \overline{U_n}$.

But as $U \cap \bigcap_{n=1}^{\infty} X_n \supset \bigcap_{n=1}^{\infty} \overline{U_n} \ni x$, this implies that $U \cap \bigcap_{n=1}^{\infty} X_n \neq \emptyset$, which completes the proof of the theorem. \square

In [Exercises 3.2 #5](#) we introduced the notion of interior of a subset of a topological space. We now formally define that term as well as exterior and boundary.

6.5.2 Definitions. Let (X, \mathcal{T}) be any topological space and A any subset of X . The largest open set contained in A is called the **interior** of A and is denoted by $\text{Int}(A)$. Each point $x \in \text{Int}(A)$ is called an **interior point** of A . The set $\text{Int}(X \setminus A)$, that is the interior of the complement of A , is denoted by $\text{Ext}(A)$, and is called the **exterior** of A and each point in $\text{Ext}(A)$ is called an **exterior point** of A . The set $\overline{A} \setminus \text{Int}(A)$ is called the **boundary** of A . Each point in the boundary of A is called a **boundary point** of A .

In [Definitions 6.5.2](#), the set X is the union of the interior of A , the exterior of A , and the boundary of A , and each of these three sets is disjoint from each of the other two sets.

6.5.3 Definition. A subset A of a topological space (X, \mathcal{T}) is said to be **nowhere dense** if the set \bar{A} has empty interior.

These definitions allow us to rephrase [Theorem 6.5.1](#).

6.5.4 Corollary. (Baire Category Theorem) Let (X, d) be a complete metric space. If $X_1, X_2, \dots, X_n, \dots$ is a sequence of subsets of X such that $X = \bigcup_{n=1}^{\infty} X_n$, then for at least one $n \in \mathbb{N}$, the set \bar{X}_n has non-empty interior; that is, X_n is not nowhere dense.

Proof. [Exercises 6.5 #2](#). □

6.5.5 Definition. A topological space (X, d) is said to be a **Baire space** if for every sequence $\{X_n\}$ of open dense subsets of X , the set $\bigcap_{n=1}^{\infty} X_n$ is also dense in X .

6.5.6 Corollary. Every complete metrizable space is a Baire space. □

6.5.7 Remarks. It is important to note that [Corollary 6.5.6](#) is a result in topology, rather than a result in metric space theory.

Note also that there are Baire spaces which are not completely metrizable. (See [Exercises 6.5 #6\(iv\)](#).) □

6.5.8 Example. The topological space \mathbb{Q} is not a Baire space and so is not completely metrizable. To see this, note that the set of rational numbers is countable and let

$\mathbb{Q} = \{x_1, x_2, \dots, x_n, \dots\}$. Each of the sets $X_n = \mathbb{Q} \setminus \{x_n\}$ is open and dense in \mathbb{Q} , however $\bigcap_{n=1}^{\infty} X_n = \emptyset$. Thus \mathbb{Q} does not have the Baire space property. \square

6.5.9 Remark. You should note that (once we had the [Baire Category Theorem 6.5.4](#)) it was harder to prove that \mathbb{Q} is not completely metrizable than the more general result that \mathbb{Q} is not a Baire space.

It is a surprising and important feature not only of topology, but of mathematics generally, that **a more general result is sometimes easier to prove**. \square

6.5.10 Definitions. Let Y be a subset of a topological space (X, \mathcal{T}) . If Y is a union of a countable number of nowhere dense subsets of X , then Y is said to be a set of the **first category** or **meager** in (X, \mathcal{T}) . If Y is not first category, it is said to be a set of the **second category** in (X, \mathcal{T}) .

The [Baire Category Theorem 6.5.4](#) has many applications in analysis, but these lie outside our study of Topology. However, we shall conclude this section with an important theorem in Banach space theory, namely the Open Mapping Theorem. This theorem is a consequence of the [Baire Category Theorem 6.5.4](#).

6.5.11 Proposition. If Y is a first category subset of a Baire space (X, \mathcal{T}) , then the interior of Y is empty.

Proof. As Y is first category, $Y = \bigcup_{n=1}^{\infty} Y_n$, where each Y_n , $n \in \mathbb{N}$, is nowhere dense.

Let $U \in \mathcal{T}$ be such that $U \subseteq Y$. Then $U \subseteq \bigcup_{n=1}^{\infty} Y_n \subseteq \bigcup_{n=1}^{\infty} \overline{Y_n}$.

So $X \setminus U \supseteq \bigcap_{n=1}^{\infty} (X \setminus \overline{Y_n})$, and each of the sets $X \setminus \overline{Y_n}$ is open and dense in (X, \mathcal{T}) . As (X, \mathcal{T}) is Baire, $\bigcap_{n=1}^{\infty} (X \setminus \overline{Y_n})$ is dense in (X, \mathcal{T}) . So the closed set $X \setminus U$ is dense in (X, \mathcal{T}) . This implies $X \setminus U = X$. Hence $U = \emptyset$. This completes the proof. \square

6.5.12 Corollary. If Y is a first category subset of a Baire space (X, \mathcal{T}) , then $X \setminus Y$ is a second category set.

Proof. If this were not the case, then the Baire space (X, \mathcal{T}) would be a countable union of nowhere dense sets. \square

6.5.13 Remark. As \mathbb{Q} is a first category subset of \mathbb{R} , it follows from Corollary 6.5.12 that the set \mathbb{P} of irrationals is a second category set. \square

6.5.14 Definition. Let S be a subset of a real vector space V . The set S is said to be **convex** if for each $x, y \in S$ and every real number $0 < \lambda < 1$, the point $\lambda x + (1 - \lambda)y$ is in S .

Clearly every subspace of a vector space is convex. Also in any normed vector space, every open ball and every closed ball is convex.

6.5.15 Theorem. (Open Mapping Theorem) Let $(B, \| \cdot \|)$ and $((B_1, \| \cdot \|_1))$ be Banach spaces and $L : B \rightarrow B_1$ a continuous linear (in the vector space sense) mapping of B onto B_1 . Then L is an open mapping.

Proof. By Exercises 6.5 #1(iv), it suffices to show that there exists an $N \in \mathbb{N}$ such that $L(B_N(0)) \supset B_s(0)$, for some $s > 0$.

Clearly $B = \bigcup_{n=1}^{\infty} B_n(0)$ and as L is surjective we have $B_1 = L(B) = \bigcup_{n=1}^{\infty} L(B_n(0))$.

As B_1 is a Banach space, by Corollary 6.5.4 of the Baire Category Theorem, there is an $N \in \mathbb{N}$, such that $\overline{L(B_N(0))}$ has non-empty interior.

So there is a $z \in B_1$ and $t > 0$, such that $B_t(z) \subseteq \overline{L(B_N(0))}$.

By Exercises 6.5 #3 there is no loss of generality in assuming that $z \in L(B_N(0))$.

But $B_t(z) = B_t(0) + z$, and so

$$B_t(0) \subseteq \overline{L(B_N(0))} - z = \overline{L(B_N(0)) - z} \subseteq \overline{L(B_N(0)) - L(B_N(0))} \subseteq \overline{L(B_{2N}(0))}.$$

which, by the linearity of L , implies that $B_{t/2}(0) \subseteq \overline{L(B_N(0))}$.

We shall show that this implies that $B_{t/4}(0) \subseteq L(B_N(0))$.

Let $w \in B_{t/2}(0)$. Then there is an $x_1 \in B_N(0)$, such that $\|w - L(x_1)\|_1 < \frac{t}{4}$.

Note that by linearity of the mapping L , for each integer $k > 0$

$$B_{t/2}(0) \subseteq \overline{L(B_N(0))} \implies B_{t/(2k)}(0) \subseteq \overline{L(B_{N/k}(0))}.$$

So there is an $x_2 \in B_{N/2}(0)$, such that

$$\|(w - L(x_1)) - L(x_2)\|_1 = \|w - L(x_1) - L(x_2)\|_1 < \frac{t}{8}.$$

Continuing in this way, we obtain by induction a sequence $\{x_m\}$ such that $\|x_m\| < \frac{N}{2^{m-1}}$ and

$$\|w - L(x_1 + x_2 + \cdots + x_m)\|_1 = \|w - L(x_1) - L(x_2) - \cdots - L(x_m)\|_1 < \frac{t}{2^m}.$$

Since B is complete, the series $\sum_{m=1}^{\infty} x_m$ converges to a limit a .

Clearly $\|a\| < 2N$ and by continuity of L , we have $w = L(a) \in L(B_{2N}(0))$.

So $B_{t/2}(0) \subseteq L(B_{2N}(0))$ and thus $B_{t/4}(0) \subseteq L(B_N(0))$ which completes the proof. □

The following Corollary of the [Open Mapping Theorem](#) follows immediately and is a very important special case.

6.5.16 Corollary. A one-to-one continuous linear map of one Banach space onto another Banach space is a homeomorphism. In particular, a one-to-one continuous linear map of a Banach space onto itself is a homeomorphism. \square

Exercises 6.5

Open Mapping

1. Let (X, \mathcal{T}) and (Y, \mathcal{T}_1) be topological spaces. A mapping $f : (X, \mathcal{T}) \rightarrow (Y, \mathcal{T}_1)$ is said to be an **open mapping** if for every open subset A of (X, \mathcal{T}) , the set $f(A)$ is open in (Y, \mathcal{T}_1) .
 - (i) Show that f is an open mapping if and only if for each $U \in \tau$ and each $x \in U$, the set $f(U)$ is a neighbourhood of $f(x)$.
 - (ii) Let (X, d) and (Y, d_1) be metric spaces and f a mapping of X into Y . Prove that f is an open mapping if and only if for each $n \in \mathbb{N}$ and each $x \in X$, $f(B_{1/n}(x)) \supseteq B_r(f(x))$, for some $r > 0$.
 - (iii) Let $(N, || ||)$ and $(N_1, || ||_1)$ be normed vector spaces and f a linear mapping of N into N_1 . Prove that f is an open mapping if and only if for each $n \in \mathbb{N}$, $f(B_{1/n}(0)) \supseteq B_r(0)$, for some $r > 0$.
 - (iv) Let $(N, || ||)$ and $(N_1, || ||_1)$ be normed vector spaces and f a linear mapping of N into N_1 . Prove that f is an open mapping if and only if there exists an $s > 0$ such that $f(B_s(0)) \supseteq B_r(0)$, for some $r > 0$.
2. Using the [Baire Category Theorem 6.5.4](#), prove [Corollary 6.5.4](#).
3. Let A be a subset of a Banach space B . Prove the following are equivalent:
 - (i) the set \overline{A} has non-empty interior;
 - (ii) there exists a $z \in \overline{A}$ and $t > 0$ such that $B_t(z) \subseteq \overline{A}$;
 - (ii) there exists a $y \in A$ and $r > 0$ such that $B_r(y) \subseteq \overline{A}$.

Isolated Points, Derived Sets, and Perfect Spaces

4. A point x in a topological space (X, \mathcal{T}) is said to be an **isolated point** if $\{x\} \in \mathcal{T}$. If S is a subset of X , then the set of all limit points of S , denoted by S' , is said to be the **derived set** of S . The set S is said to be a **perfect set** if $S' = S$; in the case that $S = X$, the topological space (X, \mathcal{T}) is said to be a **perfect space**.
- (i) Prove that if (X, \mathcal{T}) is a countable T_1 -space with no isolated points, then it is not a Baire space.
- (ii) Prove that a set S in a topological space (X, \mathcal{T}) is a perfect set if and only if it is closed and has no isolated points. Deduce that (X, \mathcal{T}) is a perfect space if and only if it has no isolated points.
- (iii) If (X, \mathcal{T}) is a perfect space and A is either an open set or a dense set in (X, \mathcal{T}) , then A has no isolated points.

Function Continuous at a Point

5. (i) Using the version of the Baire Category Theorem in [Corollary 6.5.4](#), prove that \mathbb{P} is not an F_σ -set and \mathbb{Q} is not a G_δ -set in \mathbb{R} .
 [Hint: Suppose that $\mathbb{P} = \bigcup_{n=1}^{\infty} F_n$, where each F_n is a closed subset of \mathbb{R} . Then apply [Corollary 6.5.4](#) to $\mathbb{R} = \bigcup_{n=1}^{\infty} F_n \cup \bigcup_{q \in \mathbb{Q}} \{q\}$.]
- (ii) Let $f : \mathbb{R} \rightarrow \mathbb{R}$ be a function mapping \mathbb{R} into itself. Then f is said to be **continuous at a point** $a \in \mathbb{R}$ if for each open set U containing $f(a)$, there exists an open set V containing a such that $f(V) \subseteq U$. Prove that the set of points in \mathbb{R} at which f is continuous is a G_δ -set.
- (iii) Deduce from (i) and (ii) that there is no function $f : \mathbb{R} \rightarrow \mathbb{R}$ which is continuous precisely at the set of all rational numbers.

6. (i) Let (X, \mathcal{T}) be any topological space, and Y and S dense subsets of X . If S is also open in (X, \mathcal{T}) , prove that $S \cap Y$ is dense in both X and Y .
- (ii) Let \mathcal{T}_1 be the topology induced on Y by \mathcal{T} on X . Let $\{X_n\}$ be a sequence of open dense subsets of X . Using (i), show that $\{X_n \cap Y\}$ is a sequence of open dense subsets of (Y, \mathcal{T}_1) .
- (iii) Deduce from Definition 6.5.5 and (ii) above, that if (Y, \mathcal{T}_1) is a Baire space, then (X, \mathcal{T}) is also a Baire space. [So **the closure of a Baire space is a Baire space.**]
- (iv) Using (iii), show that the subspace (Z, \mathcal{T}_2) of \mathbb{R}^2 given by

$$Z = \{\langle x, y \rangle : x, y \in \mathbb{R}, y > 0\} \cup \{\langle x, 0 \rangle : x \in \mathbb{Q}\},$$

is a Baire space, but is not completely metrizable as the closed subspace $\{\langle x, 0 \rangle : x \in \mathbb{Q}\}$ is homeomorphic to \mathbb{Q} which is not completely metrizable. This also shows that **a closed subspace of a Baire space is not necessarily a Baire space.**

7. Let (X, \mathcal{T}) and (Y, \mathcal{T}_1) be topological spaces and $f : (X, \mathcal{T}) \rightarrow (Y, \mathcal{T}_1)$ be a continuous open mapping. If (X, \mathcal{T}) is a Baire space, prove that (Y, \mathcal{T}_1) is a Baire space. [So **an open continuous image of a Baire space is a Baire space.**]
8. Let (Y, \mathcal{T}_1) be an open subspace of the Baire space (X, \mathcal{T}) . Prove that (Y, \mathcal{T}_1) is a Baire space. [So **an open subspace of a Baire space is a Baire space.**]

Upper and Lower Semicontinuous Functions

9. Let (X, \mathcal{T}) be a topological space. A function $f : (X, \mathcal{T}) \rightarrow \mathbb{R}$ is said to be **lower semicontinuous** if for each $r \in \mathbb{R}$, the set $f^{-1}((-\infty, r])$ is closed in (X, \mathcal{T}) . A function $f : (X, \mathcal{T}) \rightarrow \mathbb{R}$ is said to be **upper semicontinuous** if for each $r \in \mathbb{R}$, the set $f^{-1}((-\infty, r))$ is open in (X, \mathcal{T}) .

(i) Prove that f is continuous if and only if it is lower semicontinuous and upper semicontinuous.

(ii) Let (X, \mathcal{T}) be a Baire space, I an index set and for each $x \in X$, let the set $\{f_i(x) : i \in I\}$ be bounded above, where each mapping $f_i : (X, \mathcal{T}) \rightarrow \mathbb{R}$ is lower semicontinuous. Using the Baire Category Theorem prove that there exists an open subset O of (X, \mathcal{T}) such that the set $\{f_i(x) : x \in O, i \in I\}$ is bounded above.

[Hint: Let $X_n = \bigcap_{i \in I} f_i^{-1}((-\infty, n])$.]

10. Let B be a Banach space where the dimension of the underlying vector space is countable. Using the Baire Category Theorem, prove that the dimension of the underlying vector space is, in fact, finite.

11. Let $(N, || ||)$ be a normed vector space and (X, τ) a convex subset of $(N, || ||)$ with its induced topology. Show that (X, τ) is path-connected, and hence also connected. Deduce that every open ball in $(N, || ||)$ is path-connected as is $(N, || ||)$ itself.

12. Find a subset S of \mathbb{R} such that S is a proper subset of the boundary of S .

Interior and Closure Operators

13. A set S in a topological space is said to have the **Levine property** if the closure of the interior of S equals the interior of the closure of S . (See Levine [260].)

(i) Show that every finite subset of an infinite set with the cofinite topology has the Levine property.

(ii) Consider the set \mathbb{N} of natural numbers with the initial segment topology of [Exercises 1.1 #6\(i\)](#). Which subsets of \mathbb{N} have the Levine property.

(iii) Consider the set \mathbb{N} of natural numbers with the final segment topology of [Exercises 1.1 #6\(ii\)](#). Which subsets of \mathbb{N} have the Levine property.

6.6 Postscript

If you have not already done so, you should watch the YouTube videos on Sequences and Nets. These are called

[“Topology Without Tears – Video 3a & 3b– Sequences and Nets”](#)

and can be found on YouTube at

<http://youtu.be/wXkNgyVg0JE> and <http://youtu.be/xNqLF8GsRFE>

and on the Chinese Youku site at

<http://tinyurl.com/kxdefsm> and <http://tinyurl.com/kbh93so>

or by following the relevant link from

<http://www.topologywithouttears.net>.

Metric space theory is an important topic in its own right. As well, metric spaces hold an important position in the study of topology. Indeed many books on topology begin with metric spaces, and motivate the study of topology via them.

We saw that different metrics on the same set can give rise to the same topology. Such metrics are called equivalent metrics. We were introduced to the study of function spaces, and in particular, $C[0, 1]$. En route we met normed vector spaces, a central topic in functional analysis.

Not all topological spaces arise from metric spaces. We saw this by observing that topologies induced by metrics are Hausdorff.

We saw that the topology of a metric space can be described entirely in terms of its convergent sequences and that continuous functions between metric spaces can also be so described.

[Exercises 6.2 #9](#) introduced the interesting concept of distance between sets in a metric space.

We met the concepts of Cauchy sequence, complete metric space, completely metrizable space, Banach space, Polish space, and Souslin space. Completeness is an important topic in metric space theory because of the central role it plays in applications in analysis. Banach spaces are complete normed vector spaces and are used in many contexts in analysis and have a rich structure theory. We saw that every metric space has a completion, that is can be embedded isometrically in a complete metric space. For example every normed vector space has a completion which is a Banach space.

Contraction mappings were introduced in the concept of fixed points and we saw the proof of the [Contraction Mapping Theorem 6.4.4](#) which is also known as the [Banach Fixed Point Theorem 6.4.4](#). This is a very useful theorem in applications for example in the proof of existence of solutions of differential equations.

Another powerful theorem proved in this chapter was the [Baire Category Theorem 6.5.1](#). We introduced the topological notion of a Baire space and saw that every completely metrizable space is a Baire space. En route the notion of first category or meager was introduced. And then we proved the [Open Mapping Theorem 6.5.15](#) which says that a continuous linear map from a Banach space onto another Banach space must be an open mapping.

Chapter 7

Compactness

Introduction

The most important topological property is compactness. It plays a key role in many branches of mathematics. It would be fair to say that **until you understand compactness you do not understand topology!**

So what is compactness? It could be described as the topologists generalization of finiteness. The formal definition says that a topological space is compact if whenever it is a subset of a union of an infinite number of open sets then it is also a subset of a union of a finite number of these open sets. Obviously every finite subset of a topological space is compact. And we quickly see that in a discrete space a set is compact if and only if it is finite. When we move to topological spaces with richer topological structures, such as \mathbb{R} , we discover that infinite sets can be compact. Indeed all closed intervals $[a, b]$ in \mathbb{R} are compact. But intervals of this type are the only ones which are compact.

So we are led to ask: precisely which subsets of \mathbb{R} are compact? The [Heine-Borel Theorem 7.2.9](#) will tell us that the compact subsets of \mathbb{R} are precisely the sets which are both closed and bounded.

As we go farther into our study of topology, we shall see that compactness plays a crucial role. This is especially so of applications of topology to analysis.

7.1 Compact Spaces

7.1.1 Definition. Let A be a subset of a topological space (X, \mathcal{T}) . Then A is said to be **compact** if for every set I and every family of open sets, O_i , $i \in I$, such that $A \subseteq \bigcup_{i \in I} O_i$ there exists a finite subfamily $O_{i_1}, O_{i_2}, \dots, O_{i_n}$ such that $A \subseteq O_{i_1} \cup O_{i_2} \cup \dots \cup O_{i_n}$.

7.1.2 Example. If $(X, \mathcal{T}) = \mathbb{R}$ and $A = (0, \infty)$, then A is not compact.

Proof. For each positive integer i , let O_i be the open interval $(0, i)$. Then, clearly, $A \subseteq \bigcup_{i=1}^{\infty} O_i$.

But there do *not* exist i_1, i_2, \dots, i_n such that $A \subseteq (0, i_1) \cup (0, i_2) \cup \dots \cup (0, i_n)$. Therefore A is not compact. \square

7.1.3 Example. Let (X, \mathcal{T}) be any topological space and $A = \{x_1, x_2, \dots, x_n\}$ any finite subset of (X, \mathcal{T}) . Then A is compact.

Proof. Let O_i , $i \in I$, be any family of open sets such that $A \subseteq \bigcup_{i \in I} O_i$. Then for each $x_j \in A$, there exists an O_{i_j} , such that $x_j \in O_{i_j}$. Thus $A \subseteq O_{i_1} \cup O_{i_2} \cup \dots \cup O_{i_n}$. So A is compact. \square

7.1.4 Remark. So we see from [Example 7.1.3](#) that every finite set (in a topological space) is compact. Indeed “compactness” can be thought of as a topological generalization of “finiteness”. \square

7.1.5 Example. A subset A of a discrete space (X, \mathcal{T}) is compact if and only if it is finite.

Proof. If A is finite then [Example 7.1.3](#) shows that it is compact.

Conversely, let A be compact. Then the family of singleton sets $O_x = \{x\}$, $x \in A$ is such that each O_x is open and $A \subseteq \bigcup_{x \in A} O_x$. As A is compact, there exist $O_{x_1}, O_{x_2}, \dots, O_{x_n}$ such that $A \subseteq O_{x_1} \cup O_{x_2} \cup \dots \cup O_{x_n}$; that is, $A \subseteq \{x_1, \dots, x_n\}$. Hence A is a finite set. \square

Of course if all compact sets were finite then the study of “compactness” would not be interesting. However we shall see shortly that, for example, every closed interval $[a, b]$ is compact. Firstly, we introduce a little terminology.

7.1.6 Definitions. Let I be a set and $O_i, i \in I$, a family of subset of X . Let A be a subset of X . Then $O_i, i \in I$, is said to be a **covering** (or a **cover**) of X if $A \subseteq \bigcup_{i \in I} O_i$. If each $O_i, i \in I$, is an open set in (X, \mathcal{T}) , then $O_i, i \in I$ is said to be an **open covering** of A if $A \subseteq \bigcup_{i \in I} O_i$. A finite subfamily, $O_{i_1}, O_{i_2}, \dots, O_{i_n}$, of $O_i, i \in I$, is called a **finite subcovering** (of A) if $A \subseteq O_{i_1} \cup O_{i_2} \cup \dots \cup O_{i_n}$.

So we can rephrase the definition of compactness as follows:

7.1.7 Definitions. A subset A of a topological space (X, \mathcal{T}) is said to be **compact** if every open covering of A has a finite subcovering. If the compact subset A equals X , then (X, \mathcal{T}) is said to be a **compact space**.

7.1.8 Remark. We leave as an exercise the verification of the following statement:

Let A be a subset of (X, \mathcal{T}) and \mathcal{T}_1 the topology induced on A by \mathcal{T} . Then A is a compact subset of (X, \mathcal{T}) if and only if (A, \mathcal{T}_1) is a compact space.

[This statement is not as trivial as it may appear at first sight.] □

7.1.9 Proposition. The closed interval $[0, 1]$ is compact.

Proof. Let O_i , $i \in I$ be any open covering of $[0, 1]$. Then for each $x \in [0, 1]$, there is an O_i such that $x \in O_i$. As O_i is open about x , there exists an interval U_x , open in $[0, 1]$ such that $x \in U_x \subseteq O_i$.

Now define a subset S of $[0, 1]$ as follows:

$$S = \{z : [0, z] \text{ can be covered by a finite number of the sets } U_x\}.$$

[So $z \in S \Rightarrow [0, z] \subseteq U_{x_1} \cup U_{x_2} \cup \dots \cup U_{x_n}$, for some x_1, x_2, \dots, x_n .]

Now let $x \in S$ and $y \in U_x$. Then as U_x is an interval containing x and y , $[x, y] \subseteq U_x$. (Here we are assuming, without loss of generality that $x \leq y$.) So

$$[0, y] \subseteq U_{x_1} \cup U_{x_2} \cup \dots \cup U_{x_n} \cup U_x$$

and hence $y \in S$.

So for each $x \in [0, 1]$, $U_x \cap S = U_x$ or \emptyset .

This implies that

$$S = \bigcup_{x \in S} U_x$$

and

$$[0, 1] \setminus S = \bigcup_{x \notin S} U_x.$$

Thus we have that S is open in $[0, 1]$ and S is closed in $[0, 1]$. But $[0, 1]$ is connected. Therefore $S = [0, 1]$ or \emptyset .

However $0 \in S$ and so $S = [0, 1]$; that is, $[0, 1]$ can be covered by a finite number of U_x . So $[0, 1] \subseteq U_{x_1} \cup U_{x_2} \cup \dots \cup U_{x_m}$. But each U_{x_i} is contained in an O_i , $i \in I$. Hence $[0, 1] \subseteq O_{i_1} \cup O_{i_2} \cup \dots \cup O_{i_m}$ and we have shown that $[0, 1]$ is compact. \square

Exercises 7.1

1. Let (X, \mathcal{T}) be an indiscrete space. Prove that every subset of X is compact.
2. Let \mathcal{T} be the finite-closed topology on any set X . Prove that every subset of (X, \mathcal{T}) is compact.
3. Prove that each of the following spaces is *not* compact.
 - (i) $(0, 1)$;
 - (ii) $[0, 1)$;
 - (iii) \mathbb{Q} ;
 - (iv) \mathbb{P} ;
 - (v) \mathbb{R}^2 ;
 - (vi) the open disc $D = \{\langle x, y \rangle : x^2 + y^2 < 1\}$ considered as a subspace of \mathbb{R}^2 ;
 - (vii) the Sorgenfrey line;
 - (viii) $C[0, 1]$ with the topology induced by the metric d of [Example 6.1.5](#);
 - (ix) l_1, l_2, l_∞, c_0 with the topologies induced respectively by the metrics d_1, d_2, d_∞ , and d_0 of [Exercises 6.1 #7](#).
4. Is $[0, 1]$ a compact subset of the Sorgenfrey line?
5. Is $[0, 1] \cap \mathbb{Q}$ a compact subset of \mathbb{Q} ?
6. Verify that $S = \{0\} \cup \bigcup_{n=1}^{\infty} \{\frac{1}{n}\}$ is a compact subset of \mathbb{R} while $\bigcup_{n=1}^{\infty} \{\frac{1}{n}\}$ is not.

Alexander Subbasis Theorem

- 7*. Prove the **Alexander Subbasis Theorem** which says that **a topological space (X, \mathcal{T}) is compact if and only if every subbasis cover has a finite subcover**. In other words, if \mathcal{S} is a subbasis of the topology \mathcal{T} , and $O_i : i \in I, I$ an index set, is such that each $O_i \in \mathcal{S}$ and $X \subseteq \bigcup_{i \in I} O_i$, then there is a finite subcover of X by members of $O_i \in I$.
- [Hint: Use [Zorn's Lemma 10.2.16](#) to find an open subbasis cover which has no finite subcover and is maximal amongst such covers.]

7.2 The Heine-Borel Theorem

The next proposition says that “a continuous image of a compact space is compact”.

7.2.1 Proposition. Let $f : (X, \mathcal{T}) \rightarrow (Y, \mathcal{T}_1)$ be a continuous surjective map. If (X, \mathcal{T}) is compact, then (Y, \mathcal{T}_1) is compact.

Proof. Let $O_i, i \in I$, be any open covering of Y ; that is $Y \subseteq \bigcup_{i \in I} O_i$.

Then $f^{-1}(Y) \subseteq f^{-1}(\bigcup_{i \in I} O_i)$; that is, $X \subseteq \bigcup_{i \in I} f^{-1}(O_i)$.

So $f^{-1}(O_i), i \in I$, is an open covering of X .

As X is compact, there exist i_1, i_2, \dots, i_n in I such that

$$X \subseteq f^{-1}(O_{i_1}) \cup f^{-1}(O_{i_2}) \cup \dots \cup f^{-1}(O_{i_n}).$$

$$\text{So } Y = f(X)$$

$$\subseteq f(f^{-1}(O_{i_1}) \cup f^{-1}(O_{i_2}) \cup \dots \cup f^{-1}(O_{i_n}))$$

$$= f(f^{-1}(O_{i_1}) \cup f(f^{-1}(O_{i_2}))) \cup \dots \cup f(f^{-1}(O_{i_n}))$$

$$= O_{i_1} \cup O_{i_2} \cup \dots \cup O_{i_n}, \quad \text{since } f \text{ is surjective.}$$

So we have $Y \subseteq O_{i_1} \cup O_{i_2} \cup \dots \cup O_{i_n}$; that is, Y is covered by a finite number of O_i .

Hence Y is compact. □

7.2.2 Corollary. Let (X, \mathcal{T}) and (Y, \mathcal{T}_1) be homeomorphic topological spaces. If (X, \mathcal{T}) is compact, then (Y, \mathcal{T}_1) is compact. □

7.2.3 Corollary. For a and b in \mathbb{R} with $a < b$, $[a, b]$ is compact while (a, b) is not compact.

Proof. The space $[a, b]$ is homeomorphic to the compact space $[0, 1]$ and so, by [Proposition 7.2.1](#), is compact.

The space (a, b) is homeomorphic to $(0, \infty)$. If (a, b) were compact, then $(0, \infty)$ would be compact, but we saw in [Example 7.1.2](#) that $(0, \infty)$ is not compact. Hence (a, b) is not compact. \square

7.2.4 Proposition. Every closed subset of a compact space is compact.

Proof. Let A be a closed subset of a compact space (X, \mathcal{T}) . Let $U_i \in \mathcal{T}$, $i \in I$, be any open covering of A . Then

$$X \subseteq \left(\bigcup_{i \in I} U_i \right) \cup (X \setminus A);$$

that is, U_i , $i \in I$, together with the open set $X \setminus A$ is an open covering of X . Therefore there exists a finite subcovering $U_{i_1}, U_{i_2}, \dots, U_{i_k}, X \setminus A$. [If $X \setminus A$ is not in the finite subcovering then we can include it and still have a finite subcovering of X .]

So

$$X \subseteq U_{i_1} \cup U_{i_2} \cup \dots \cup U_{i_k} \cup (X \setminus A).$$

Therefore,

$$A \subseteq U_{i_1} \cup U_{i_2} \cup \dots \cup U_{i_k} \cup (X \setminus A)$$

which clearly implies

$$A \subseteq U_{i_1} \cup U_{i_2} \cup \dots \cup U_{i_k}$$

since $A \cap (X \setminus A) = \emptyset$. Hence A has a finite subcovering and so is compact. \square

7.2.5 Proposition. A compact subset of a Hausdorff topological space is closed.

Proof. Let A be a compact subset of the Hausdorff space (X, \mathcal{T}) . We shall show that A contains all its limit points and hence is closed. Let $p \in X \setminus A$. Then for each $a \in A$, there exist open sets U_a and V_a such that $a \in U_a$, $p \in V_a$ and $U_a \cap V_a = \emptyset$.

Then $A \subseteq \bigcup_{a \in A} U_a$. As A is compact, there exist a_1, a_2, \dots, a_n in A such that

$$A \subseteq U_{a_1} \cup U_{a_2} \cup \dots \cup U_{a_n}.$$

Put $U = U_{a_1} \cup U_{a_2} \cup \dots \cup U_{a_n}$ and $V = V_{a_1} \cap V_{a_2} \cap \dots \cap V_{a_n}$. Then $p \in V$ and $V_a \cap U_a = \emptyset$ implies $V \cap U = \emptyset$ which in turn implies $V \cap A = \emptyset$. So p is not a limit point of A , and V is an open set containing p which does not intersect A .

Hence A contains all of its limit points and is therefore closed. \square

7.2.6 Corollary. A compact subset of a metrizable space is closed. \square

7.2.7 Example. For a and b in \mathbb{R} with $a < b$, the intervals $[a, b)$ and $(a, b]$ are not compact as they are not closed subsets of the metrizable space \mathbb{R} . \square

7.2.8 Proposition. A compact subset of \mathbb{R} is bounded.

Proof. Let $A \subseteq \mathbb{R}$ be unbounded. Then $A \subseteq \bigcup_{n=1}^{\infty} (-n, n)$, but $\{(-n, n) : n = 1, 2, 3, \dots\}$ does not have any finite subcovering of A as A is unbounded. Therefore A is not compact. Hence all compact subsets of \mathbb{R} are bounded. \square

7.2.9 Theorem. (Heine-Borel Theorem) Every closed bounded subset of \mathbb{R} is compact.

Proof. If A is a closed bounded subset of \mathbb{R} , then $A \subseteq [a, b]$, for some a and b in \mathbb{R} . As $[a, b]$ is compact and A is a closed subset, A is compact. \square

The [Heine-Borel Theorem 7.2.9](#) is an important result. The proof above is short only because we extracted and proved [Proposition 7.1.9](#) first.

7.2.10 Proposition. (Converse of Heine-Borel Theorem) Every compact subset of \mathbb{R} is closed and bounded.

Proof. This follows immediately from [Propositions 7.2.8](#) and [7.2.5](#). □

7.2.11 Definition. A subset A of a metric space (X, d) is said to be **bounded** if there exists a real number r such that $d(a_1, a_2) \leq r$, for all a_1 and a_2 in A .

7.2.12 Proposition. Let A be a compact subset of a metric space (X, d) . Then A is closed and bounded.

Proof. By [Corollary 7.2.6](#), A is a closed set. Now fix $x_0 \in X$ and define the mapping $f : (A, \mathcal{T}) \rightarrow \mathbb{R}$ by

$$f(a) = d(a, x_0), \text{ for every } a \in A,$$

where \mathcal{T} is the induced topology on A . Then f is continuous and so, by [Proposition 7.2.1](#), $f(A)$ is compact. Thus, by [Proposition 7.2.10](#), $f(A)$ is bounded; that is, there exists a real number M such that

$$f(a) \leq M, \text{ for all } a \in A.$$

Thus $d(a, x_0) \leq M$, for all $a \in A$. Putting $r = 2M$, we see by the triangle inequality that $d(a_1, a_2) \leq r$, for all a_1 and a_2 in A . □

Recalling that \mathbb{R}^n denotes the n -dimensional euclidean space with the topology induced by the euclidean metric, it is possible to generalize the Heine-Borel Theorem and its converse from \mathbb{R} to \mathbb{R}^n , $n > 1$. We state the result here but delay its proof until the next chapter.

7.2.13 Theorem. (Generalized Heine-Borel Theorem) A subset of \mathbb{R}^n , $n \geq 1$, is compact if and only if it is closed and bounded.

Warning. Although [Theorem 7.2.13](#) says that every closed bounded subset of \mathbb{R}^n is compact, closed bounded subsets of other metric spaces need not be compact. (See [Exercises 7.2 #9.](#))

7.2.14 Proposition. Let (X, \mathcal{T}) be a compact space and f a continuous mapping from (X, \mathcal{T}) into \mathbb{R} . Then the set $f(X)$ has a greatest element and a least element.

Proof. As f is continuous, $f(X)$ is compact. Therefore $f(X)$ is a closed bounded subset of \mathbb{R} . As $f(X)$ is bounded, it has a supremum. Since $f(X)$ is closed, [Lemma 3.3.2](#) implies that the supremum is in $f(X)$. Thus $f(X)$ has a greatest element – namely its supremum. Similarly it can be shown that $f(X)$ has a least element. \square

7.2.15 Proposition. Let a and b be in \mathbb{R} and f a continuous function from $[a, b]$ into \mathbb{R} . Then $f([a, b]) = [c, d]$, for some c and d in \mathbb{R} .

Proof. As $[a, b]$ is connected, $f([a, b])$ is a connected subset of \mathbb{R} and hence is an interval. As $[a, b]$ is compact, $f([a, b])$ is compact. So $f([a, b])$ is a closed bounded interval. Hence

$$f([a, b]) = [c, d]$$

for some c and d in \mathbb{R} . \square

Exercises 7.2

1. Which of the following subsets of \mathbb{R} are compact? (Justify your answers.)
 - (i) \mathbb{Z} ;
 - (ii) $\{\frac{\sqrt{2}}{n} : n = 1, 2, 3, \dots\}$;
 - (iii) $\{x : x = \cos y, y \in [0, 1]\}$;
 - (iv) $\{x : x = \tan y, y \in [0, \pi/2)\}$.

2. Which of the following subsets of \mathbb{R}^2 are compact? (Justify your answers.)
 - (i) $\{\langle x, y \rangle : x^2 + y^2 = 4\}$
 - (ii) $\{\langle x, y \rangle : x \geq y + 1\}$
 - (iii) $\{\langle x, y \rangle : 0 \leq x \leq 2, 0 \leq y \leq 4\}$
 - (iv) $\{\langle x, y \rangle : 0 < x < 2, 0 \leq y \leq 4\}$

3. Let (X, \mathcal{T}) be a compact space. If $\{F_i : i \in I\}$ is a family of closed subsets of X such that $\bigcap_{i \in I} F_i = \emptyset$, prove that there is a finite subfamily $F_{i_1}, F_{i_2}, \dots, F_{i_m}$ such that $F_{i_1} \cap F_{i_2} \cap \dots \cap F_{i_m} = \emptyset$.

4. [Corollary 4.3.7](#) says that for real numbers a, b, c and d with $a < b$ and $c < d$,
 - (i) $(a, b) \not\cong [c, d]$
 - (ii) $[a, b) \not\cong [c, d]$.

Prove each of these using a compactness argument (rather than a connectedness argument as was done in [Corollary 4.3.7](#)).

Closed Mapping

5. Let (X, \mathcal{T}) and (Y, \mathcal{T}_1) be topological spaces. A mapping $f : (X, \mathcal{T}) \rightarrow (Y, \mathcal{T}_1)$ is said to be a **closed mapping** if for every closed subset A of (X, \mathcal{T}) , $f(A)$ is closed in (Y, \mathcal{T}_1) . A function $f : (X, \mathcal{T}) \rightarrow (Y, \mathcal{T}_1)$ is said to be an **open mapping** if for every open subset A of (X, \mathcal{T}) , $f(A)$ is open in (Y, \mathcal{T}_1) .
- (a) Find examples of mappings f which are
- (i) open but not closed
 - (ii) closed but not open
 - (iii) open but not continuous
 - (iv) closed but not continuous
 - (v) continuous but not open
 - (vi) continuous but not closed.
- (b) If (X, \mathcal{T}) and (Y, \mathcal{T}_1) are compact Hausdorff spaces and $f : (X, \mathcal{T}) \rightarrow (Y, \mathcal{T}_1)$ is a continuous mapping, prove that f is a closed mapping.
6. Let $f : (X, \mathcal{T}) \rightarrow (Y, \mathcal{T}_1)$ be a continuous bijection. If (X, \mathcal{T}) is compact and (Y, \mathcal{T}_1) is Hausdorff, prove that f is a homeomorphism.
7. Let $\{C_j : j \in J\}$ be a family of closed compact subsets of a topological space (X, \mathcal{T}) . Prove that $\bigcap_{j \in J} C_j$ is compact.
8. Let n be a positive integer, d the euclidean metric on \mathbb{R}^n , and X a subset of \mathbb{R}^n . Prove that X is bounded in (\mathbb{R}^n, d) if and only if there exists a positive real number M such that for all $\langle x_1, x_2, \dots, x_n \rangle \in X$, $-M \leq x_i \leq M$, $i = 1, 2, \dots, n$.

9. Let $(C[0, 1], d^*)$ be the metric space defined in [Example 6.1.6](#). Let $B = \{f : f \in C[0, 1] \text{ and } d^*(f, 0) \leq 1\}$ where 0 denotes the constant function from $[0, 1]$ into \mathbb{R} which maps every element to zero. (The set B is called the **closed unit ball**.)
- (i) Verify that B is closed and bounded in $(C[0, 1], d^*)$.
 - (ii) Prove that B is not compact. [Hint: Let $\{B_i : i \in I\}$ be the family of all open balls of radius $\frac{1}{2}$ in $(C[0, 1], d^*)$. Then $\{B_i : i \in I\}$ is an open covering of B . Suppose there exists a finite subcovering B_1, B_2, \dots, B_N . Consider the $(N + 1)$ functions $f_\alpha : [0, 1] \rightarrow \mathbb{R}$ given by $f_\alpha(x) = \sin(2^{N-\alpha} \cdot \pi \cdot x)$, $\alpha = 1, 2, \dots, N + 1$.
 - (a) Verify that each $f_\alpha \in B$.
 - (b) Observing that $f_{N+1}(1) = 1$ and $f_m(1) = 0$, for all $m \leq N$, deduce that if $f_{N+1} \in B_1$ then $f_m \notin B_1$, $m = 1, \dots, N$.
 - (c) Observing that $f_N(\frac{1}{2}) = 1$ and $f_m(\frac{1}{2}) = 0$, for all $m \leq N - 1$, deduce that if $f_N \in B_2$ then $f_m \notin B_2$, $m = 1, \dots, N - 1$.
 - (d) Continuing this process, show that f_1, f_2, \dots, f_{N+1} lie in distinct B_i – a contradiction.]
10. Prove that every compact Hausdorff space is a normal space.
- 11.* Let A and B be disjoint compact subsets of a Hausdorff space (X, \mathcal{T}) . Prove that there exist disjoint open sets G and H such that $A \subseteq G$ and $B \subseteq H$.
12. Let (X, \mathcal{T}) be an infinite topological space with the property that every subspace is compact. Prove that (X, \mathcal{T}) is not a Hausdorff space.
13. Prove that every uncountable topological space which is not compact has an uncountable number of subsets which are compact and an uncountable number which are not compact.
14. If (X, \mathcal{T}) is a Hausdorff space such that every proper closed subspace is compact, prove that (X, \mathcal{T}) is compact.

Relatively Compact Spaces

15. A subset A of a topological space (X, \mathcal{T}) is said to be **relatively compact** if its closure, \overline{A} , is compact. If (X, \mathcal{T}) is a Hausdorff space, verify the following:
- (i) every compact subset of (X, \mathcal{T}) is relatively compact;
 - (ii) every subset of a compact subset of (X, \mathcal{T}) is relatively compact;
 - (iii) if (X, \mathcal{T}) is \mathbb{R} with the euclidean topology, then the open interval $(0, 1)$ is relatively compact;
 - (iv) if (X, \mathcal{T}) is \mathbb{R} with the euclidean topology, then \mathbb{Z} is not a relatively compact subset;
 - (v) is the set \mathbb{Q} a relatively compact subset of \mathbb{R} ?
 - (vi) there is an uncountable number of relatively compact subsets of \mathbb{R} which are not compact;
 - (vii) an infinite discrete space can be a relatively compact subset of a compact Hausdorff space.
[Hint: Consider an infinite convergent sequence in \mathbb{R} or use [Definition 10.4.1.](#)]
 - (viii) an infinite discrete subgroup cannot be a relatively compact subset of a Hausdorff topological group.
[Hint: Use [Proposition A5.2.8.](#)]

Supercompact Spaces

- 16.* A topological space (X, \mathcal{T}) is said to be **supercompact** if there is a subbasis \mathcal{S} for the topology \mathcal{T} such that if $O_i, i \in I$ is any open cover of X with $O_i \in \mathcal{S}$, for all $i \in I$, then there exist $j, k \in I$ such that $X = O_j \cup O_k$. Prove that $[0, 1]$ with the euclidean topology is supercompact.

Countably Compact Spaces and Locally Compact Spaces

17. A topological space (X, \mathcal{T}) is said to be **countably compact** if every countable open covering of X has a finite subcovering.
- (i) Show that every compact space is countably compact.
 - (ii) Prove that a metrizable space is countably compact if and only if it is compact.
 - (iii) A topological space (X, \mathcal{T}) is said to be **locally compact** if each point $x \in X$ has at least one neighbourhood which is compact. Find an example of a locally compact Hausdorff space which is not countably compact.
 - (iv) Show that every continuous image of a countably compact space is countably compact.
 - (v) Using (iv) and (ii) above and [Proposition 7.2.14](#), prove that if f is a continuous mapping of a countably compact space (X, \mathcal{T}) into \mathbb{R} , then $f(X)$ has a greatest element and a least element.
 - (vi) Show that a closed subspace of a countably compact space is countably compact.
 - (vii) Prove that a topological space (X, \mathcal{T}) is countably compact if and only if every countable family of closed subsets which has the finite intersection property has non-empty intersection.
 - (viii) Prove that the topological space (X, \mathcal{T}) is countably compact if and only if for every decreasing sequence $S_1 \supset S_2 \supset \cdots \supset S_n \dots$ of nonempty closed subsets of (X, \mathcal{T}) the intersection $\bigcap_{i=1}^{\infty} S_i$ is non-empty.
 - (ix) Using (vii), prove that a topological space (X, \mathcal{T}) is countably compact space if and only if every countably infinite subset of X has a limit point.

Convergent Sequences

18. In [Definitions 6.2.1](#) we defined the notion of a convergent sequence in a metric space. We now generalize this to a convergent sequence in a topological space. Let (X, \mathcal{T}) be a topological space and $x_1, x_2, \dots, x_n, \dots$ be a sequence of points in X . Then the sequence is said to **converge** to x if, for each open set U in (X, \mathcal{T}) , there exists an $N \in \mathbb{N}$ such that $x_n \in U$, for every $n \geq N$; this is denoted by $x_n \rightarrow x$. The sequence $y_1, y_2, \dots, y_n, \dots$ of points in X is said to be **convergent** if there exists a point $y \in X$ such that $y_n \rightarrow y$.
- (i) Let (X, \mathcal{T}) be a Hausdorff space. Prove that every convergent sequence in (X, \mathcal{T}) converges to precisely one point.
- (ii) Give an example of a sequence in some topological space (Z, \mathcal{T}) which converges to an infinite number of points.

Sequentially Compact Spaces

19. A topological space (X, \mathcal{T}) is said to be **sequentially compact** if every sequence in (X, \mathcal{T}) has a convergent subsequence. Prove that **every sequentially compact space is countably compact**.

Pseudocompact Spaces

20. A topological space (X, \mathcal{T}) is said to be **pseudocompact** if every continuous function $(X, \mathcal{T}) \rightarrow \mathbb{R}$ is bounded.
- (i) Verify that every compact space is pseudocompact.
- (ii) Using [Exercise #17](#) above, show that **any countably compact space is pseudocompact**.
- (iii) Show that **every continuous image of a pseudocompact space is pseudocompact**.

21.* Let (X, \mathcal{T}) be a normal Hausdorff topological space which is not countably compact.

(i) Using [Exercise 17 \(ix\) above](#) show that there is a subset $A = \{x_1, x_2, \dots, x_n, \dots\}$ of X with $x_i \neq x_j$, for $i \neq j$, such that A has no limit points in (X, \mathcal{T}) and deduce that A with its induced topology \mathcal{T}_A is a discrete closed subspace of (X, \mathcal{T}) .

(ii) Using [Tietze's Extension Theorem 10.3.51](#), which is proved in [Chapter 10](#), show that there exists a continuous function $f : (X, \mathcal{T}) \rightarrow \mathbb{R}$ with $f(x_n) = n$, for each $n \in \mathbb{N}$.

(iii) Deduce from (ii) above that a normal Hausdorff topological space which is not countably compact is also not pseudocompact and hence that **any pseudocompact Hausdorff normal space is countably compact.**

22. Verify that [for metrizable spaces](#)

[sequentially compact](#) \iff [compact](#) \iff [countably compact](#) \iff [pseudocompact](#).

7.3 Postscript

Compactness plays a key role in applications of topology to all branches of analysis. As noted in [Remark 7.1.4](#) it can be thought as a topological generalization of finiteness.

The [Generalized Heine-Borel Theorem 7.2.13](#) characterizes the compact subsets of \mathbb{R}^n as those which are closed and bounded.

Compactness is a topological property. Indeed any continuous image of a compact space is compact.

Closed subsets of compact spaces are compact and compact subspaces of Hausdorff spaces are closed.

[Exercises 7.2 #5](#) introduces the notions of open mappings and closed mappings. [Exercises 7.2 #10](#) notes that a compact Hausdorff space is a normal space (indeed a T_4 -space). That the closed unit ball in each \mathbb{R}^n is compact contrasts with [Exercises 7.2 #9](#). This exercise points out that the closed unit ball in the metric space $(C[0, 1], d^*)$ is not compact. Though we shall not prove it here, it can be shown that a normed vector space is finite-dimensional if and only if its closed unit ball is compact.

In [Exercise 7.2 #17, 19](#) and [20](#) the concepts of countably compact, sequentially compact and pseudocompact are introduced and in [Exercise 7.2 #22](#) they are shown to be equivalent to the concept of compact for metrizable spaces.

Warning. It is unfortunate that “compact” is defined in different ways in different books and some of these are not equivalent to the definition presented here. Firstly some books include Hausdorff in the definition of compact and use quasicompact to denote what we have called compact. Some books, particularly older ones, use “compact” to mean sequentially compact. Finally the term “bikompakt” is often used to mean compact or compact Hausdorff in our sense. So one needs to be careful to see what the author actually means.

Chapter 8

Finite Products

Introduction

There are three important ways of creating new topological spaces from old ones. They are by forming “subspaces”, “quotient spaces”, and “product spaces”. The next three chapters are devoted to the study of product spaces. Quotient spaces are dealt with in [Chapter 11](#). In this chapter we investigate finite products and prove Tychonoff’s Theorem. This seemingly innocuous theorem says that any product of compact spaces is compact. So we are led to ask: precisely which subsets of \mathbb{R}^n , $n \in \mathbb{N}$, are compact? The [Generalized Heine-Borel Theorem 8.3.3](#) will tell us that the compact subsets of \mathbb{R}^n are precisely the sets which are both closed and bounded.

As we go farther into our study of topology, we shall see that compactness plays a crucial role. This is especially so of applications of topology to analysis.

8.1 The Product Topology

If X_1, X_2, \dots, X_n are sets then the **product** $X_1 \times X_2 \times \cdots \times X_n$ is the set consisting of all the ordered n -tuples $\langle x_1, x_2, \dots, x_n \rangle$, where $x_i \in X_i$, $i = 1, \dots, n$.

The problem we now discuss is:

Given topological spaces $(X_1, \mathcal{T}_1), (X_2, \mathcal{T}_2), \dots, (X_n, \mathcal{T}_n)$ how do we define a reasonable topology \mathcal{T} on the product set $X_1 \times X_2 \times \cdots \times X_n$?

An obvious (but incorrect!) candidate for \mathcal{T} is the set of all sets $O_1 \times O_2 \times \cdots \times O_n$, where $O_i \in \mathcal{T}_i$, $i = 1, \dots, n$. Unfortunately this is not a topology.

For example, if $n = 2$ and $(X, \mathcal{T}_1) = (X, \mathcal{T}_2) = \mathbb{R}$ then \mathcal{T} would contain the rectangles $(0, 1) \times (0, 1)$ and $(2, 3) \times (2, 3)$ but not the set $[(0, 1) \times (0, 1)] \cup [(2, 3) \times (2, 3)]$, since this is not $O_1 \times O_2$ for any choice of O_1 and O_2 .

[If it were $O_1 \times O_2$ for some O_1 and O_2 , then $\frac{1}{2} \in (0, 1) \subseteq O_1$ and $2\frac{1}{2} \in (2, 3) \subseteq O_2$ and so the ordered pair $\langle \frac{1}{2}, 2\frac{1}{2} \rangle \in O_1 \times O_2$ but $\langle \frac{1}{2}, 2\frac{1}{2} \rangle \notin [(0, 1) \times (0, 1)] \cup [(2, 3) \times (2, 3)]$.] Thus \mathcal{T} is not closed under unions and so is not a topology.

However we have already seen how to put a topology (the euclidean topology) on $\mathbb{R}^2 = \mathbb{R} \times \mathbb{R}$. This was done in [Example 2.2.9](#). Indeed this example suggests how to define the product topology in general.

8.1.1 Definitions. Let $(X_1, \mathcal{T}_1), (X_2, \mathcal{T}_2), \dots, (X_n, \mathcal{T}_n)$ be topological spaces. Then the **product topology** \mathcal{T} on the set $X_1 \times X_2 \times \cdots \times X_n$ is the topology having the family $\{O_1 \times O_2 \times \cdots \times O_n, O_i \in \mathcal{T}_i, i = 1, \dots, n\}$ as a basis. The set $X_1 \times X_2 \times \cdots \times X_n$ with the topology \mathcal{T} is said to be the **product of the spaces** $(X_1, \mathcal{T}_1), (X_2, \mathcal{T}_2), \dots, (X_n, \mathcal{T}_n)$ and is denoted by $(X_1 \times X_2 \times \cdots \times X_n, \mathcal{T})$ or $(X_1, \mathcal{T}_1) \times (X_2, \mathcal{T}_2) \times \cdots \times (X_n, \mathcal{T}_n)$.

Of course it must be verified that

the family $\{O_1 \times O_2 \times \cdots \times O_n : O_i \in \mathcal{T}_i, i = 1, \dots, n\}$ is a basis for a topology; that is, it satisfies the conditions of [Proposition 2.2.8](#). (This is left as an exercise.)

8.1.2 Proposition. Let $\mathcal{B}_1, \mathcal{B}_2, \dots, \mathcal{B}_n$ be bases for the topological spaces $(X_1, \mathcal{T}_1), (X_2, \mathcal{T}_2), \dots, (X_n, \mathcal{T}_n)$, respectively. Then the family of sets $\{O_1 \times O_2 \times \dots \times O_n : O_i \in \mathcal{B}_i, i = 1, \dots, n\}$ is a basis for the product topology on $X_1 \times X_2 \times \dots \times X_n$.

The proof of [Proposition 8.1.2](#) is straightforward and is also left as an exercise for you.

8.1.3 Observations (i) We now see that the euclidean topology on \mathbb{R}^n , $n \geq 2$, is just the product topology on the set $\mathbb{R} \times \mathbb{R} \times \dots \times \mathbb{R} = \mathbb{R}^n$. (See [Example 2.2.9](#) and [Remark 2.2.10](#).)

(ii) It is clear from [Definitions 8.1.1](#) that any product of open sets is an open set or more precisely: if O_1, O_2, \dots, O_n are open subsets of topological spaces $(X_1, \mathcal{T}_1), (X_2, \mathcal{T}_2), \dots, (X_n, \mathcal{T}_n)$, respectively, then $O_1 \times O_2 \times \dots \times O_n$ is an open subset of $(X_1, \mathcal{T}_1) \times (X_2, \mathcal{T}_2) \times \dots \times (X_n, \mathcal{T}_n)$. The next proposition says that any product of closed sets is a closed set.

8.1.4 Proposition. Let C_1, C_2, \dots, C_n be closed subsets of the topological spaces $(X_1, \mathcal{T}_1), (X_2, \mathcal{T}_2), \dots, (X_n, \mathcal{T}_n)$, respectively. Then $C_1 \times C_2 \times \dots \times C_n$ is a closed subset of the product space $(X_1 \times X_2 \times \dots \times X_n, \mathcal{T})$.

Proof. Observe that

$$\begin{aligned} & (X_1 \times X_2 \times \dots \times X_n) \setminus (C_1 \times C_2 \times \dots \times C_n) \\ &= [(X_1 \setminus C_1) \times X_2 \times \dots \times X_n] \cup [X_1 \times (X_2 \setminus C_2) \times X_3 \times \dots \times X_n] \cup \\ & \quad \dots \cup [X_1 \times X_2 \times \dots \times X_{n-1} \times (X_n \setminus C_n)] \end{aligned}$$

which is a union of open sets (as a product of open sets is open) and so is an open set in $(X_1, \mathcal{T}_1) \times (X_2, \mathcal{T}_2) \times \dots \times (X_n, \mathcal{T}_n)$. Therefore its complement, $C_1 \times C_2 \times \dots \times C_n$, is a closed set, as required. \square

Exercises 8.1

1. Prove [Proposition 8.1.2](#).
2. If $(X_1, \mathcal{T}_1), (X_2, \mathcal{T}_2), \dots, (X_n, \mathcal{T}_n)$ are discrete spaces, prove that the product space $(X_1, \mathcal{T}_1) \times (X_2, \mathcal{T}_2) \times \cdots \times (X_n, \mathcal{T}_n)$ is also a discrete space.
3. Let X_1 and X_2 be infinite sets and \mathcal{T}_1 and \mathcal{T}_2 the finite-closed topology on X_1 and X_2 , respectively. Show that the product topology, \mathcal{T} , on $X_1 \times X_2$ is not the finite-closed topology.
4. Prove that the product of any finite number of indiscrete spaces is an indiscrete space.
5. Prove that the product of any finite number of Hausdorff spaces is Hausdorff.
6. Let (X, \mathcal{T}) be a topological space and $D = \{(x, x) : x \in X\}$ the diagonal in the product space $(X, \mathcal{T}) \times (X, \mathcal{T}) = (X \times X, \mathcal{T}_1)$. Prove that (X, \mathcal{T}) is a Hausdorff space if and only if D is closed in $(X \times X, \mathcal{T}_1)$.
7. Let $(X_1, \mathcal{T}_1), (X_2, \mathcal{T}_2)$ and (X_3, \mathcal{T}_3) be topological spaces. Prove that
$$[(X_1, \mathcal{T}_1) \times (X_2, \mathcal{T}_2)] \times (X_3, \mathcal{T}_3) \cong (X_1, \mathcal{T}_1) \times (X_2, \mathcal{T}_2) \times (X_3, \mathcal{T}_3).$$
8. (i) Let (X_1, \mathcal{T}_1) and (X_2, \mathcal{T}_2) be topological spaces. Prove that
$$(X_1, \mathcal{T}_1) \times (X_2, \mathcal{T}_2) \cong (X_2, \mathcal{T}_2) \times (X_1, \mathcal{T}_1).$$
(ii) Generalize the above result to products of any finite number of topological spaces.

9. Let C_1, C_2, \dots, C_n be subsets of the topological spaces $(X_1, \mathcal{T}_1), (X_2, \mathcal{T}_2), \dots, (X_n, \mathcal{T}_n)$, respectively, so that $C_1 \times C_2 \times \dots \times C_n$ is a subset of the space $(X_1, \mathcal{T}_1) \times (X_2, \mathcal{T}_2) \times \dots \times (X_n, \mathcal{T}_n)$. Prove each of the following statements.
- (i) $(C_1 \times C_2 \times \dots \times C_n)' \supseteq C_1' \times C_2' \times \dots \times C_n'$;
 - (ii) $\overline{C_1 \times C_2 \times \dots \times C_n} = \overline{C_1} \times \overline{C_2} \times \dots \times \overline{C_n}$;
 - (iii) if C_1, C_2, \dots, C_n are dense in $(X_1, \mathcal{T}_1), (X_2, \mathcal{T}_2), \dots, (X_n, \mathcal{T}_n)$, respectively, then $C_1 \times C_2 \times \dots \times C_n$ is dense in the product space $(X_1, \mathcal{T}_1) \times (X_2, \mathcal{T}_2) \times \dots \times (X_n, \mathcal{T}_n)$;
 - (iv) if $(X_1, \mathcal{T}_1), (X_2, \mathcal{T}_2), \dots, (X_n, \mathcal{T}_n)$ are separable spaces, then $(X_1, \mathcal{T}_1) \times (X_2, \mathcal{T}_2) \times \dots \times (X_n, \mathcal{T}_n)$ is a separable space;
 - (v) for each $n \geq 1$, \mathbb{R}^n is a separable space.
10. Show that the product of a finite number of T_1 -spaces is a T_1 -space.
11. If $(X_1, \mathcal{T}_1), \dots, (X_n, \mathcal{T}_n)$ satisfy the second axiom of countability, show that $(X_1, \mathcal{T}_1) \times (X_2, \mathcal{T}_2) \times \dots \times (X_n, \mathcal{T}_n)$ satisfies the second axiom of countability also.
12. Let $(\mathbb{R}, \mathcal{T}_1)$ be the Sorgenfrey line, defined in [Exercises 3.2 #11](#), and $(\mathbb{R}^2, \mathcal{T}_2)$ be the product space $(\mathbb{R}, \mathcal{T}_1) \times (\mathbb{R}, \mathcal{T}_1)$. Prove the following statements.
- (i) $\{\langle x, y \rangle : a \leq x < b, c \leq y < d, a, b, c, d \in \mathbb{R}\}$ is a basis for the topology \mathcal{T}_2 .
 - (ii) $(\mathbb{R}^2, \mathcal{T}_2)$ is a regular separable totally disconnected Hausdorff space.
 - (iii) Let $L = \{\langle x, y \rangle : x, y \in \mathbb{R} \text{ and } x + y = 0\}$. Then the line L is closed in the euclidean topology on the plane and hence also in $(\mathbb{R}^2, \mathcal{T}_2)$.
 - (iv) If \mathcal{T}_3 is the subspace topology induced on the line L by \mathcal{T}_2 , then \mathcal{T}_3 is the discrete topology, and hence (L, \mathcal{T}_3) is not a separable space. [As (L, \mathcal{T}_3) is a closed subspace of the separable space $(\mathbb{R}^2, \mathcal{T}_2)$, we now know that **a closed subspace of a separable space is not necessarily separable.**]
[Hint: show that $L \cap \{\langle x, y \rangle : a \leq x < a + 1, -a \leq y < -a + 1, a \in \mathbb{R}\}$ is a singleton set.]

8.2 Projections onto Factors of a Product

Before proceeding to our next result we need a couple of definitions.

8.2.1 Definitions. Let \mathcal{T}_1 and \mathcal{T}_2 be topologies on a set X . Then \mathcal{T}_1 is said to be a **finer topology** than \mathcal{T}_2 (and \mathcal{T}_2 is said to be a **coarser topology** than \mathcal{T}_1) if $\mathcal{T}_1 \supseteq \mathcal{T}_2$.

8.2.2 Example. The discrete topology on a set X is finer than any other topology on X . The indiscrete topology on X is coarser than any other topology on X . [See also [Exercises 5.1 #10.](#)] \square

8.2.3 Definitions. Let (X, \mathcal{T}) and (Y, \mathcal{T}_1) be topological spaces and f a mapping from X into Y . Then f is said to be an **open mapping** if for every $A \in \mathcal{T}$, $f(A) \in \mathcal{T}_1$. The mapping f is said to be a **closed mapping** if for every closed set B in (X, \mathcal{T}) , $f(B)$ is closed in (Y, \mathcal{T}_1) .

8.2.4 Remark. In [Exercises 7.2 #5](#), you were asked to show that none of the conditions “continuous mapping”, “open mapping”, “closed mapping”, implies either of the other two conditions. Indeed no two of these conditions taken together implies the third. (Find examples to verify this.) \square

8.2.5 Proposition. Let $(X_1, \mathcal{T}_1), (X_2, \mathcal{T}_2), \dots, (X_n, \mathcal{T}_n)$ be topological spaces and $(X_1 \times X_2 \times \dots \times X_n, \mathcal{T})$ their product space.

For each $i \in \{1, \dots, n\}$, let $p_i : X_1 \times X_2 \times \dots \times X_n \rightarrow X_i$ be the projection mapping; that is, $p_i(\langle x_1, x_2, \dots, x_i, \dots, x_n \rangle) = x_i$, for each $\langle x_1, x_2, \dots, x_i, \dots, x_n \rangle \in X_1 \times X_2 \times \dots \times X_n$. Then

- (i) each p_i is a continuous surjective open mapping, and
- (ii) \mathcal{T} is the coarsest topology on the set $X_1 \times X_2 \times \dots \times X_n$ such that each p_i is continuous.

Proof. Clearly each p_i is surjective. To see that each p_i is continuous, let U be any open set in (X_i, \mathcal{T}_i) . Then

$$p_i^{-1}(U) = X_1 \times X_2 \times \dots \times X_{i-1} \times U \times X_{i+1} \times \dots \times X_n$$

which is a product of open sets and so is open in $(X_1 \times X_2 \times \dots \times X_n, \mathcal{T})$. Hence each p_i is continuous.

To show that p_i is an open mapping it suffices to verify that for each basic open set $U_1 \times U_2 \times \dots \times U_n$, where U_j is open in (X_j, \mathcal{T}_j) , for $j = 1, \dots, n$, the set $p_i(U_1 \times U_2 \times \dots \times U_n)$ is open in (X_i, \mathcal{T}_i) . But $p_i(U_1 \times U_2 \times \dots \times U_n) = U_i$ which is, of course, open in (X_i, \mathcal{T}_i) . So each p_i is an open mapping. We have now verified part (i) of the proposition.

Now let \mathcal{T}' be any topology on the set $X_1 \times X_2 \times \dots \times X_n$ such that each projection mapping $p_i : (X_1 \times X_2 \times \dots \times X_n, \mathcal{T}') \rightarrow (X_i, \mathcal{T}_i)$ is continuous. We have to show that $\mathcal{T}' \supseteq \mathcal{T}$.

Recalling the definition of the basis for the topology \mathcal{T} (given in [Definition 8.1.1](#)) it suffices to show that if O_1, O_2, \dots, O_n are open sets in $(X_1, \mathcal{T}_1), (X_2, \mathcal{T}_2), \dots, (X_n, \mathcal{T}_n)$ respectively, then $O_1 \times O_2 \times \dots \times O_n \in \mathcal{T}'$. To show this, observe that as p_i is continuous, $p_i^{-1}(O_i) \in \mathcal{T}'$, for each $i = 1, \dots, n$. Now

$$p_i^{-1}(O_i) = X_1 \times X_2 \times \dots \times X_{i-1} \times O_i \times X_{i+1} \times \dots \times X_n,$$

so that

$$\bigcap_{i=1}^n p_i^{-1}(O_i) = O_1 \times O_2 \times \dots \times O_n.$$

Then $p_i^{-1}(O_i) \in \mathcal{T}'$ for $i = 1, \dots, n$, implies $\bigcap_{i=1}^n p_i^{-1}(O_i) \in \mathcal{T}'$; that is, $O_1 \times O_2 \times \dots \times O_n \in \mathcal{T}'$, as required. □

8.2.6 Remark. Proposition 8.2.5 (ii) gives us another way of defining the product topology. **Given topological spaces $(X_1, \tau_1), (X_2, \tau_2), \dots, (X_n, \tau_n)$ the product topology can be defined as the coarsest topology on $X_1 \times X_2 \times \dots \times X_n$ such that each projection $p_i : X_1 \times X_2 \times \dots \times X_n \rightarrow X_i$ is continuous.** This observation will be of greater significance in the next section when we proceed to a discussion of products of an infinite number of topological spaces. \square

8.2.7 Corollary. For $n \geq 2$, the projection mappings of \mathbb{R}^n onto \mathbb{R} are continuous open mappings. \square

8.2.8 Proposition. Let $(X_1, \mathcal{T}_1), (X_2, \mathcal{T}_2), \dots, (X_n, \mathcal{T}_n)$ be topological spaces and $(X_1 \times X_2 \times \dots \times X_n, \mathcal{T})$ the product space. Then each (X_i, \mathcal{T}_i) is homeomorphic to a subspace of $(X_1 \times X_2 \times \dots \times X_n, \mathcal{T})$.

Proof. For each j , let a_j be any (fixed) element in X_j . For each i , define a mapping

$f_i : (X_i, \mathcal{T}_i) \rightarrow (X_1 \times X_2 \times \dots \times X_n, \mathcal{T})$ by

$$f_i(x) = \langle a_1, a_2, \dots, a_{i-1}, x, a_{i+1}, \dots, a_n \rangle.$$

We claim that $f_i : (X_i, \mathcal{T}_i) \rightarrow (f_i(X_i), \mathcal{T}')$ is a homeomorphism, where \mathcal{T}' is the topology induced on $f_i(X_i)$ by \mathcal{T} . Clearly this mapping is one-to-one and onto. Let $U \in \mathcal{T}_i$. Then

$$\begin{aligned} f_i(U) &= \{a_1\} \times \{a_2\} \times \dots \times \{a_{i-1}\} \times U \times \{a_{i+1}\} \times \dots \times \{a_n\} \\ &= (X_1 \times X_2 \times \dots \times X_{i-1} \times U \times X_{i+1} \times \dots \times X_n) \cap \\ &\quad (\{a_1\} \times \{a_2\} \times \dots \times \{a_{i-1}\} \times X_i \times \{a_{i+1}\} \times \dots \times \{a_n\}) \\ &= (X_1 \times X_2 \times \dots \times X_{i-1} \times U \times X_{i+1} \times \dots \times X_n) \cap f_i(X_i) \\ &\in \mathcal{T}' \end{aligned}$$

since $X_1 \times X_2 \times \dots \times X_{i-1} \times U \times X_{i+1} \times \dots \times X_n \in \mathcal{T}$. So $U \in \mathcal{T}_i$ implies that $f_i(U) \in \mathcal{T}'$.

Finally, observe that the family

$$\{(U_1 \times U_2 \times \dots \times U_n) \cap f_i(X_i) : U_i \in \mathcal{T}_i, i = 1, \dots, n\}$$

is a basis for \mathcal{T}' , so to prove that f_i is continuous it suffices to verify that the inverse image under f_i of every member of this family is open in (X_i, \mathcal{T}_i) . But

$$\begin{aligned} f_i^{-1}[(U_1 \times U_2 \times \dots \times U_n) \cap f_i(X_i)] &= f_i^{-1}(U_1 \times U_2 \times \dots \times U_n) \cap f_i^{-1}(f_i(X_i)) \\ &= \begin{cases} U_i \cap X_i, & \text{if } a_j \in U_j, j \neq i \\ \emptyset, & \text{if } a_j \notin U_j, \text{ for some } j \neq i. \end{cases} \end{aligned}$$

As $U_i \cap X_i = U_i \in \mathcal{T}_i$ and $\emptyset \in \mathcal{T}_i$ we infer that f_i is continuous, and so we have the required result. \square

Notation. If X_1, X_2, \dots, X_n are sets then the product $X_1 \times X_2 \times \dots \times X_n$ is denoted by $\prod_{i=1}^n X_i$. If $(X_1, \mathcal{T}_1), (X_2, \mathcal{T}_2), \dots, (X_n, \mathcal{T}_n)$ are topological spaces, then the product space $(X_1, \mathcal{T}_1) \times (X_2, \mathcal{T}_2) \times \dots \times (X_n, \mathcal{T}_n)$ is denoted by $\prod_{i=1}^n (X_i, \mathcal{T}_i)$. \square

Exercises 8.2

1. Prove that the euclidean topology on \mathbb{R} is finer than the finite-closed topology.
2. Let (X_i, \mathcal{T}_i) be a topological space, for $i = 1, \dots, n$. Prove that
 - (i) if $\prod_{i=1}^n (X_i, \mathcal{T}_i)$ is connected, then each (X_i, \mathcal{T}_i) is connected;
 - (ii) if $\prod_{i=1}^n (X_i, \mathcal{T}_i)$ is compact, then each (X_i, \mathcal{T}_i) is compact;
 - (iii) if $\prod_{i=1}^n (X_i, \mathcal{T}_i)$ is path-connected, then each (X_i, \mathcal{T}_i) is path-connected;
 - (iv) if $\prod_{i=1}^n (X_i, \mathcal{T}_i)$ is Hausdorff, then each (X_i, \mathcal{T}_i) is Hausdorff;
 - (v) if $\prod_{i=1}^n (X_i, \mathcal{T}_i)$ is a T_1 -space, then each (X_i, \mathcal{T}_i) is a T_1 -space.
3. Let (Y, \mathcal{T}) and (X_i, \mathcal{T}_i) , $i = 1, 2, \dots, n$ be topological spaces. Further for each i , let f_i be a mapping of (Y, \mathcal{T}) into (X_i, \mathcal{T}_i) . Prove that the mapping $f: (Y, \mathcal{T}) \rightarrow \prod_{i=1}^n (X_i, \mathcal{T}_i)$, given by

$$f(y) = \langle f_1(y), f_2(y), \dots, f_n(y) \rangle,$$

is continuous if and only if every f_i is continuous.

[Hint: Observe that $f_i = p_i \circ f$, where p_i is the projection mapping of $\prod_{j=1}^n (X_j, \mathcal{T}_j)$ onto (X_i, \mathcal{T}_i) .]

4. Let (X, d_1) and (Y, d_2) be metric spaces. Further let e be the metric on $X \times Y$ defined in Exercises 6.1 #4. Also let \mathcal{T} be the topology induced on $X \times Y$ by e . If d_1 and d_2 induce the topologies \mathcal{T}_1 and \mathcal{T}_2 on X and Y , respectively, and \mathcal{T}_3 is the product topology of $(X, \mathcal{T}_1) \times (Y, \mathcal{T}_2)$, prove that $\mathcal{T} = \mathcal{T}_3$. [This shows that **the product of any two metrizable spaces is metrizable**.]
5. Let $(X_1, \mathcal{T}_1), (X_2, \mathcal{T}_2), \dots, (X_n, \mathcal{T}_n)$ be topological spaces. Prove that $\prod_{i=1}^n (X_i, \mathcal{T}_i)$ is a metrizable space if and only if each (X_i, \mathcal{T}_i) is metrizable.

[Hint: Use **Exercises 6.1 #6**, which says that every subspace of a metrizable space is metrizable, and **Exercise 4 above**.]

8.3 Tychonoff's Theorem for Finite Products

8.3.1 Theorem. (Tychonoff's Theorem for Finite Products) If $(X_1, \mathcal{T}_1), (X_2, \mathcal{T}_2), \dots, (X_n, \mathcal{T}_n)$ are compact spaces, then $\prod_{i=1}^n (X_i, \mathcal{T}_i)$ is a compact space.

Proof. Consider first the product of two compact spaces (X, \mathcal{T}_1) and (Y, \mathcal{T}_2) . Let $U_i, i \in I$ be any open covering of $X \times Y$. Then for each $x \in X$ and $y \in Y$, there exists an $i \in I$ such that $\langle x, y \rangle \in U_i$. So there is a basic open set $V(x, y) \times W(x, y)$, such that $V(x, y) \in \mathcal{T}_1, W(x, y) \in \mathcal{T}_2$ and $\langle x, y \rangle \in V(x, y) \times W(x, y) \subseteq U_i$.

As $\langle x, y \rangle$ ranges over all points of $X \times Y$ we obtain an open covering $V(x, y) \times W(x, y), x \in X, y \in Y$, of $X \times Y$ such that each $V(x, y) \times W(x, y)$ is a subset of some $U_i, i \in I$. Thus to prove $(X, \mathcal{T}_1) \times (Y, \mathcal{T}_2)$ is compact it suffices to find a finite subcovering of the open covering $V(x, y) \times W(x, y), x \in X, y \in Y$.

Now fix $x_0 \in X$ and consider the subspace $\{x_0\} \times Y$ of $X \times Y$. As seen in Proposition 8.2.8 this subspace is homeomorphic to (Y, \mathcal{T}_2) and so is compact. As $V(x_0, y) \times W(x_0, y), y \in Y$, is an open covering of $\{x_0\} \times Y$ it has a finite subcovering:

$$V(x_0, y_1) \times W(x_0, y_1), V(x_0, y_2) \times W(x_0, y_2), \dots, V(x_0, y_m) \times W(x_0, y_m).$$

Put $V(x_0) = V(x_0, y_1) \cap V(x_0, y_2) \cap \dots \cap V(x_0, y_m)$. Then we see that the set $V(x_0) \times Y$ is contained in the union of a finite number of sets of the form $V(x_0, y) \times W(x_0, y), y \in Y$.

Thus to prove $X \times Y$ is compact it suffices to show that $X \times Y$ is contained in a finite union of sets of the form $V(x) \times Y$. As each $V(x)$ is an open set containing $x \in X$, the family $V(x), x \in X$, is an open covering of the compact space (X, \mathcal{T}_1) . Therefore there exist x_1, x_2, \dots, x_k such that $X \subseteq V(x_1) \cup V(x_2) \cup \dots \cup V(x_k)$. Thus $X \times Y \subseteq (V(x_1) \times Y) \cup (V(x_2) \times Y) \cup \dots \cup (V(x_k) \times Y)$, as required. Hence $(X, \mathcal{T}_1) \times (Y, \mathcal{T}_2)$ is compact.

The proof is completed by induction. Assume that the product of any N compact spaces is compact. Consider the product $(X_1, \mathcal{T}_1) \times (X_2, \mathcal{T}_2) \times \dots \times (X_{N+1}, \mathcal{T}_{N+1})$ of compact spaces $(X_i, \mathcal{T}_i), i = 1, \dots, N + 1$. Then

$$\begin{aligned} & (X_1, \mathcal{T}_1) \times (X_2, \mathcal{T}_2) \times \dots \times (X_{N+1}, \mathcal{T}_{N+1}) \\ & \cong [(X_1, \mathcal{T}_1) \times \dots \times (X_N, \mathcal{T}_N)] \times (X_{N+1}, \mathcal{T}_{N+1}). \end{aligned}$$

By our inductive hypothesis $(X_1, \mathcal{T}_1) \times \cdots \times (X_N, \mathcal{T}_N)$ is compact, so the right-hand side is the product of two compact spaces and thus is compact. Therefore the left-hand side is also compact. This completes the induction and the proof of the theorem. \square

Using [Proposition 7.2.1](#) and [8.2.5 \(i\)](#) we immediately obtain:

8.3.2 Proposition. (Converse of Tychonoff's Theorem) Let $(X_1, \mathcal{T}_1), (X_2, \mathcal{T}_2), \dots, (X_n, \mathcal{T}_n)$ be topological spaces. If $\prod_{i=1}^n (X_i, \mathcal{T}_i)$ is compact, then each (X_i, \mathcal{T}_i) is compact. \square

We can now prove the previously stated [Theorem 7.2.13](#).

8.3.3 Theorem. (Generalized Heine-Borel Theorem) A subset of \mathbb{R}^n , $n \geq 1$ is compact if and only if it is closed and bounded.

Proof. That any compact subset of \mathbb{R}^n is bounded can be proved in an analogous fashion to [Proposition 7.2.8](#). Thus by [Proposition 7.2.5](#) any compact subset of \mathbb{R}^n is closed and bounded.

Conversely let S be any closed bounded subset of \mathbb{R}^n . Then, by [Exercises 7.2 #8](#), S is a closed subset of the product

$$\overbrace{[-M, M] \times [-M, M] \times \cdots \times [-M, M]}^{n \text{ terms}}$$

for some positive real number M . As each closed interval $[-M, M]$ is compact, by [Corollary 7.2.3](#), Tychonoff's Theorem implies that the product space

$$[-M, M] \times [-M, M] \times \cdots \times [-M, M]$$

is also compact. As S is a closed subset of a compact set, it too is compact. \square

8.3.4 Example. Define the subspace \mathbf{S}^1 of \mathbb{R}^2 by

$$\mathbf{S}^1 = \{\langle x, y \rangle : x^2 + y^2 = 1\}.$$

Then \mathbf{S}^1 is a closed bounded subset of \mathbb{R}^2 and thus is compact.

Similarly we define the **n-sphere** \mathbf{S}^n as the subspace of \mathbb{R}^{n+1} given by

$$\mathbf{S}^n = \{\langle x_1, x_2, \dots, x_{n+1} \rangle : x_1^2 + x_2^2 + \dots + x_{n+1}^2 = 1\}.$$

Then \mathbf{S}^n is a closed bounded subset of \mathbb{R}^{n+1} and so is compact.

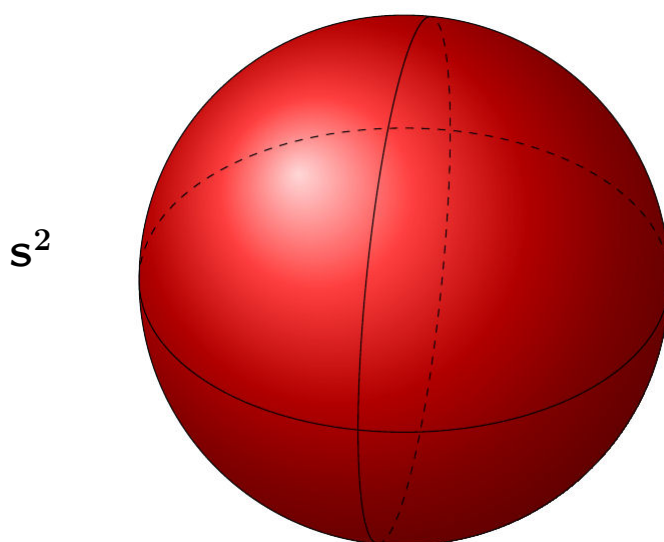

We define $\mathbf{S}^1 \times \mathbf{S}^1$ to be the **torus**.

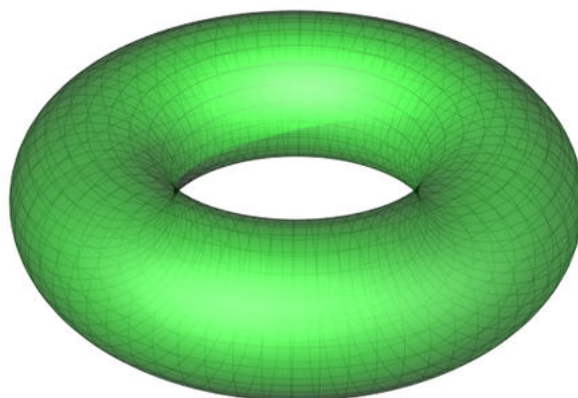

□

8.3.5 Example. The subspace $\mathbf{S}^1 \times [0, 1]$ of \mathbb{R}^3 is the product of two compact spaces and so is compact. (Convince yourself that $\mathbf{S}^1 \times [0, 1]$ is the surface of a cylinder.)

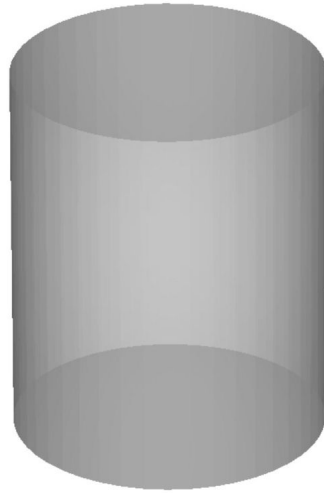

□

Exercises 8.3

Locally Compact Spaces

1. A topological space (X, \mathcal{T}) is said to be **locally compact** if each point $x \in X$ has at least one neighbourhood which is compact. Prove that
 - (i) Every compact space is locally compact.
 - (ii) \mathbb{R} and \mathbb{Z} are locally compact (but not compact).
 - (iii) Every discrete space is locally compact.
 - (iv) If $(X_1, \mathcal{T}_1), (X_2, \mathcal{T}_2), \dots, (X_n, \mathcal{T}_n)$ are locally compact spaces, then $\prod_{i=1}^n (X_i, \mathcal{T}_i)$ is locally compact.
 - (v) Every closed subspace of a locally compact space is locally compact.
 - (vi) A continuous image of a locally compact space is not necessarily locally compact.
 - (vii) If f is a continuous open mapping of a locally compact space (X, \mathcal{T}) onto a topological space (Y, \mathcal{T}_1) , then (Y, \mathcal{T}_1) is locally compact.
 - (viii) If $(X_1, \mathcal{T}_1), (X_2, \mathcal{T}_2), \dots, (X_n, \mathcal{T}_n)$ are topological spaces such that $\prod_{i=1}^n (X_i, \mathcal{T}_i)$ is locally compact, then each (X_i, \mathcal{T}_i) is locally compact.
- 2.* Let (Y, \mathcal{T}_1) be a locally compact subspace of the Hausdorff space (X, \mathcal{T}) . If Y is dense in (X, \mathcal{T}) , prove that Y is open in (X, \mathcal{T}) .
[Hint: Use [Exercises 3.2 #9](#).]

**Divisible Groups, Separable Banach Spaces, Locally Convex Spaces,
Compactly Generated Banach Spaces, Topological Vector Spaces,
Seminorms, Convex, Absolutely Convex, Absorbent, and Balanced Sets**

3. A group G is said to be **divisible** if for each $g \in G$ and each $n \in \mathbb{N}$, there exists an $h \in G$ such that $h^n = g$. Examples of divisible groups include \mathbb{R} , \mathbb{Q} and every vector space over \mathbb{R} or \mathbb{C} , while \mathbb{Z} is not a divisible group. (See [Definition A5.3.4](#).)
 - (i) Let (G, d) be a metrizable topological group (see [Appendix 5](#)) with d a left-invariant metric (that is, $d(ag, ah) = d(g, h)$, for all $a, g, h \in G$). Verify that if $g \in G$ and $h \in G$ satisfies $h^n = g$, then $d(h, 1) \leq \frac{1}{n}d(g, 1)$, where 1 is the identity element of the group G .

- (ii) Deduce from (i) that if G is separable with $\{x_1, x_2, \dots, x_n, \dots\}$ dense in G , and $\{y_1, y_2, \dots, y_n, \dots\}$ is such that each y_n satisfies $y_n^{m_n} = x_n$ where m_n is n times $(1 + \text{the integer part of } d(x_n, 1))$, then the sequence $y_1, y_2, \dots, y_n, \dots$ converges to $1 \in G$.
- (iv) Deduce that the set $Y = \{1, y_1, y_2, \dots, y_n, \dots\}$ is compact and the group $\text{gp}(Y)$ it generates is dense in G . So **every separable metrizable divisible topological group has a dense subgroup which is generated by a compact set.**
- (v) Conversely, prove that **if the metrizable topological group G has a dense subgroup which is generated by a compact set, then G is separable.** (This result should be contrasted with that in Exercises 10.3 #33.)
- (vi) A Banach space B is said to be **compactly generated** if it has a compact subset Y such that any vector space containing Y is dense in B . Prove using (iv) and (v) that **a Banach space is separable if and only if it is compactly generated.** (This result should be contrasted with that in Exercises 10.3 #33 (vii).) Deduce that **a Banach space is separable if and only if it is generated by a sequence of elements $y_1, y_2, \dots, y_n, \dots$ with $\|y_n\| < \frac{1}{n}$, for each positive integer n , such that the sequence converges to 0.**
- (vii) Let $F = \mathbb{R}$ or \mathbb{C} with its usual topology. A vector space V over the field F with V having topology \mathcal{T} is said to be a **topological vector space** if addition and scalar multiplication are continuous; that is, the map $(x, y) \mapsto x + y : V \times V \rightarrow V$, for all $x, y \in V$, is continuous, where $V \times V$ has the product topology, and the map $(\lambda, x) \mapsto \lambda x : F \times V \rightarrow V$, $x \in V$, $\lambda \in F$, where $F \times V$ has the product topology, is continuous. Verify each of the following:
- every topological vector space is a topological group;
 - each Banach space and each normed space determines a topological vector space;
 - if V is a vector space over F and $0 \neq \lambda \in F$, then $f : V \rightarrow V$ given by $f(x) = \lambda x$, for each $x \in V$, is a homeomorphism of V onto V . Deduce that if U is a neighbourhood of 0 in V , then λU is a neighbourhood of 0.

(viii) A subset C of a vector space V over F is said to be **convex** if for each $x, y \in C$ and each $t \in (0, 1)$, the point $tx + (1 - t)y \in C$. The subset C is said to be **absolutely convex** if for all $\lambda_1, \lambda_2 \in F$, with $|\lambda_1| + |\lambda_2| \leq 1$, $\lambda_1 x_1 + \lambda_2 x_2 \in C$, for all $x_1, x_2 \in C$. A subset C of a vector space V is said to be **absorbent** if for each $x \in V$, there is a $\lambda > 0$ such that $x \in \mu C$ for all $\mu \geq \lambda$. If V is a topological vector space, prove each of the following:

- (a) any finite intersection of absorbent sets is absorbent;
- (b) any intersection of convex sets is convex;
- (c) any intersection of absolutely convex sets is absolutely convex;
- (d) a union of convex sets is not necessarily convex;
- (e) an absolutely convex set C in V is absorbent if and only if C spans V , that is, V is the smallest vector space containing C ;
- (f) if U is any neighbourhood of 0 in the topological vector space V , then U is absorbent.
 [Hint: in (f) use the fact that the function $f(\lambda) = \lambda x$ is continuous at $\lambda = 0$, for each $x \in V$, and so there is a neighbourhood $\{\lambda : |\lambda| \leq \varepsilon\}$ which is mapped into U .]
- (g) each of its convex subsets and each of its its absolutely convex sets is path-connected;
- (h) the interior of each convex set (respectively, absolutely convex set) in V is convex (respectively, absolutely convex);
- (i) the closure of each convex set (respectively, absolutely convex set) in V is convex (respectively, absolutely convex).

(ix) A topological vector space V over $F = \mathbb{R}$ or \mathbb{C} is said to be a **locally convex space** if it has a base of neighbourhoods of 0 consisting of convex sets.

For example, in a normed vector space the open balls containing 0 are a base of neighbourhoods of 0 and each is a convex set. So every normed vector space and, in particular, every Banach space is a locally convex space.

A subset S of V is said to be **balanced** if for all $x \in S$ and $|\lambda| \leq 1$, $\lambda x \in S$.

Verify each of the following:

(a) a subset S of V is absolutely convex if and only if it is balanced and convex;

(b) if U is a convex neighbourhood of 0 , then $\bigcap_{|\lambda| \geq 1} \lambda U$, $\lambda \in F$, is a balanced convex neighbourhood of 0 contained in U ;

(c) a topological vector space V over F is locally convex if and only if it has a basis of neighbourhoods of 0 each of which is absolutely convex;

(d) if V_1 and V_2 are topological vector spaces over \mathbb{R} , then $V_1 \times V_2$ with the product topology is a topological vector space over \mathbb{R} ;

(e) if V_1 and V_2 are locally convex spaces, then $V_1 \times V_2$ with the product topology is a locally convex space.

(x) Show that **a metrizable topological vector space V is separable if and only if it has a compact subset K such that any vector space containing K is dense in V .**

(xi)(a) Let G be a topological group. Prove that G is separable if and only if it has subgroups $G_1 \subseteq G_2 \subseteq \cdots \subseteq G_n \subseteq \cdots$ such that the set $\bigcup_{i=1}^{\infty} G_i$ is dense in G , where each G_i is the smallest subgroup of G containing a finite set of elements.

(b) Let N be a normed vector space. Prove that N is separable and infinite-dimensional if and only if $N_1 \subsetneq N_2 \subsetneq \cdots \subsetneq N_i \subsetneq \cdots$ with $\bigcup_{i=1}^{\infty} N_i$ dense in N , where each N_i is a finite-dimensional normed vector subspace of N .

(c) If N in (b) is a Banach space, show that $\bigcup_{i=1}^{\infty} N_i \neq N$.

(xii) Let V be a vector space over $F = \mathbb{R}$ or \mathbb{C} . A mapping $p : V \rightarrow \mathbb{R}$ is said to be a **seminorm** if it satisfies

- (α) $p(x) \geq 0$, for all $x \in V$;
- (β) $p(\lambda x) = |\lambda|p(x)$, for all $x \in V$ and $\lambda \in F$;
- (γ) $p(x + y) \leq p(x) + p(y)$, for all $x, y \in V$.

Obviously if $p(x) = 0$ implies $x = 0$, then p is a norm. Verify each of the following:

- (a) If p is a seminorm on V , then for each $r \in \mathbb{R}$ with $r > 0$, the sets $\{x : x \in V, p(x) < r\}$ and $\{x : x \in V, p(x) \leq r\}$ are absolutely convex and absorbent;
- (b) Let S be an absolutely convex absorbent subset of V . Then p_S defined by

$$p_S(x) = \inf\{\lambda : \lambda > 0, x \in \lambda S\}$$

is a seminorm on V and

$$\{p_S(x) : x \in V, p_S(x) < 1\} \subseteq S \subseteq \{p_S(x) : x \in V, p_S(x) \leq 1\}.$$

- (c) Let $\{p_\alpha : \alpha \in I\}$, for some index set I , be any set of seminorms on V . Let \mathcal{T} be the coarsest topology on V such that each $p_\alpha : V \rightarrow \mathbb{R}$ is continuous. Then V with the topology \mathcal{T} is a locally convex space. Conversely, if (V, \mathcal{T}) is a locally convex space and $\{p_\alpha : \alpha \in I\}$, for some index set I , is the set of all seminorms on V such that each $p_\alpha : (V, \mathcal{T}) \rightarrow \mathbb{R}$ is continuous, then \mathcal{T} is the coarsest topology such that each p_α is continuous.
- (d) Let (V, \mathcal{T}) a locally convex space and $\{p_\alpha : \alpha \in I\}$, for some index set I , the set of all continuous seminorms on (V, \mathcal{T}) . Then \mathcal{T} is Hausdorff if and only if for each $0 \neq x \in V$, there exists an $\alpha \in I$ such that $p_\alpha(x) \neq 0$.
- (e)* Let V be the vector space of all continuous functions $(-\infty, \infty) \rightarrow \mathbb{R}$. With the seminorms

$$p_n(x) = \sup_{-n \leq t \leq n} |x(t)|, \quad n \in \mathbb{N}$$

V is a locally convex space which is Hausdorff, indeed metrizable. Further, with this topology it is not a normable vector space (that is the topological vector space underlying a normed vector space).

4. Verify all the containments in the diagram below.

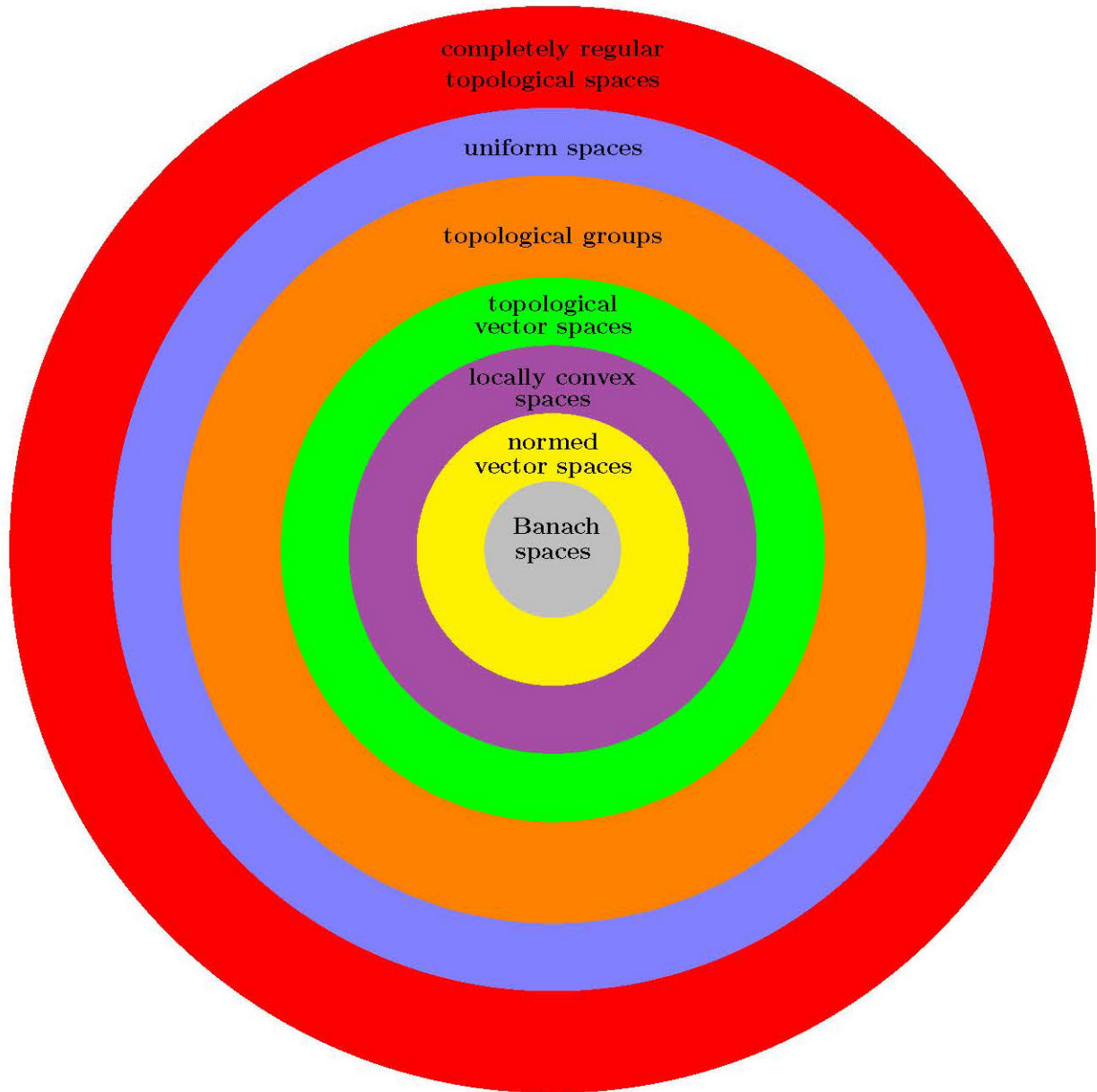

8.4 Products and Connectedness

8.4.1 Definition. Let (X, \mathcal{T}) be a topological space and let x be any point in X . The **component in X of x , $C_X(x)$** , is defined to be the union of all connected subsets of X which contain x .

8.4.2 Proposition. Let x be any point in a topological space (X, \mathcal{T}) . Then $C_X(x)$ is connected.

Proof. Let $\{C_i : i \in I\}$ be the family of all connected subsets of (X, \mathcal{T}) which contain x . (Observe that $\{x\} \in \{C_i : i \in I\}$.) Then $C_X(x) = \bigcup_{i \in I} C_i$.

Let O be a subset of $C_X(x)$ which is clopen in the topology induced on $C_X(x)$ by \mathcal{T} . Then $O \cap C_i$ is clopen in the induced topology on C_i , for each i .

But as each C_i is connected, $O \cap C_i = C_i$ or \emptyset , for each i . If $O \cap C_j = C_j$ for some $j \in I$, then $x \in O$. So, in this case, $O \cap C_i \neq \emptyset$, for all $i \in I$ as each C_i contains x . Therefore $O \cap C_i = C_i$, for all $i \in I$ or $O \cap C_i = \emptyset$, for all $i \in I$; that is, $O = C_X(x)$ or $O = \emptyset$.

So $C_X(x)$ has no proper non-empty clopen subset and hence is connected. \square

8.4.3 Remark. We see from [Definition 8.4.1](#) and [Proposition 8.4.2](#) that $C_X(x)$ is the largest connected subset of X which contains x . \square

8.4.4 Lemma. Let a and b be points in a topological space (X, \mathcal{T}) . If there exists a connected set C containing both a and b then $C_X(a) = C_X(b)$.

Proof. By Definition 8.4.1, $C_X(a) \supseteq C$ and $C_X(b) \supseteq C$. Therefore $a \in C_X(b)$.

By Proposition 8.4.2, $C_X(b)$ is connected and so is a connected set containing a . Thus, by Definition 8.4.1, $C_X(a) \supseteq C_X(b)$.

Similarly $C_X(b) \supseteq C_X(a)$, and we have shown that $C_X(a) = C_X(b)$. \square

8.4.5 Proposition. Let $(X_1, \mathcal{T}_1), (X_2, \mathcal{T}_2), \dots, (X_n, \mathcal{T}_n)$ be topological spaces. Then $\prod_{i=1}^n (X_i, \mathcal{T}_i)$ is connected if and only if each (X_i, \mathcal{T}_i) is connected.

Proof. To show that the product of a finite number of connected spaces is connected, it suffices to prove that the product of any two connected spaces is connected, as the result then follows by induction.

So let (X, \mathcal{T}) and (Y, \mathcal{T}_1) be connected spaces and $\langle x_0, y_0 \rangle$ any point in the product space $(X \times Y, \mathcal{T}_2)$. Let $\langle x_1, y_1 \rangle$ be any other point in $X \times Y$. Then the subspace $\{x_0\} \times Y$ of $(X \times Y, \mathcal{T})$ is homeomorphic to the connected space (Y, \mathcal{T}_1) and so is connected.

Similarly the subspace $X \times \{y_1\}$ is connected. Furthermore, $\langle x_0, y_1 \rangle$ lies in the connected space $\{x_0\} \times Y$, so $C_{X \times Y}(\langle x_0, y_1 \rangle) \supseteq \{x_0\} \times Y \ni \langle x_0, y_0 \rangle$, while $\langle x_0, y_1 \rangle \in X \times \{y_1\}$, and so $C_{X \times Y}(\langle x_0, y_1 \rangle) \supseteq X \times \{y_1\} \ni \langle x_1, y_1 \rangle$.

Thus $\langle x_0, y_0 \rangle$ and $\langle x_1, y_1 \rangle$ lie in the connected set $C_{X \times Y}(\langle x_0, y_1 \rangle)$, and so by Lemma 8.4.4, $C_{X \times Y}(\langle x_0, y_0 \rangle) = C_{X \times Y}(\langle x_1, y_1 \rangle)$. In particular, $\langle x_1, y_1 \rangle \in C_{X \times Y}(\langle x_0, y_0 \rangle)$. As $\langle x_1, y_1 \rangle$ was an arbitrary point in $X \times Y$, we have that $C_{X \times Y}(\langle x_0, y_0 \rangle) = X \times Y$. Hence $(X \times Y, \mathcal{T}_2)$ is connected.

Conversely if $\prod_{i=1}^n (X_i, \mathcal{T}_i)$ is connected then Propositions 8.2.5 and 5.2.1 imply that each (X_i, \mathcal{T}_i) is connected. \square

8.4.6 Remark. In Exercises 5.2 #9 the following result appears: **For any point x in any topological space (X, \mathcal{T}) , the component $C_X(x)$ is a closed set.** \square

8.4.7 Definition. A topological space is said to be a **continuum** if it is compact and connected.

As an immediate consequence of Theorem 8.3.1 and Propositions 8.4.5 and 8.3.2 we have the following proposition.

8.4.8 Proposition. Let $(X_1, \mathcal{T}_1), (X_2, \mathcal{T}_2), \dots, (X_n, \mathcal{T}_n)$ be topological spaces. Then $\prod_{i=1}^n (X_i, \mathcal{T}_i)$ is a continuum if and only if each (X_i, \mathcal{T}_i) is a continuum. \square

Exercises 8.4

Compactum

1. A topological space (X, \mathcal{T}) is said to be a **compactum** if it is compact and metrizable. Let $(X_1, \mathcal{T}_1), (X_2, \mathcal{T}_2), \dots, (X_n, \mathcal{T}_n)$ be topological spaces. Using Exercises 8.2 #5, prove that $\prod_{i=1}^n (X_i, \mathcal{T}_i)$ is a compactum if and only if each (X_i, \mathcal{T}_i) is a compactum.
2. Let (X, d) be a metric space and \mathcal{T} the topology induced on X by d .
 - (i) Prove that the function d from the product space $(X, \mathcal{T}) \times (X, \mathcal{T})$ into \mathbb{R} is continuous.
 - (ii) Using (i) show that if the metrizable space (X, \mathcal{T}) is connected and X has at least 2 points, then X has the uncountable number of points.
3. If (X, \mathcal{T}) and (Y, \mathcal{T}_1) are path-connected spaces, prove that the product space $(X, \mathcal{T}) \times (Y, \mathcal{T}_1)$ is path-connected.

4. (i) Let $x = (x_1, x_2, \dots, x_n)$ be any point in the product space

$(Y, \mathcal{T}) = \prod_{i=1}^n (X_i, \mathcal{T}_i)$. Prove that

$$C_Y(x) = C_{X_1}(x_1) \times C_{X_2}(x_2) \times \cdots \times C_{X_n}(x_n).$$

(ii) Deduce from (i) and [Exercises 5.2 #10](#) that $\prod_{i=1}^n (X_i, \mathcal{T}_i)$ is totally disconnected if and only if each (X_i, \mathcal{T}_i) is totally disconnected.

Locally Connected Spaces

5. A topological space (X, \mathcal{T}) is said to be **locally connected** if it has a basis B consisting of connected (open) sets.

(i) Verify that \mathbb{Z} is a locally connected space which is not connected.

(ii) Show that \mathbb{R}^n and \mathbf{S}^n are locally connected, for all $n \geq 1$.

(iii) Let (X, \mathcal{T}) be the subspace of \mathbb{R}^2 consisting of the points in the line segments joining $\langle 0, 1 \rangle$ to $\langle 0, 0 \rangle$ and to all the points $\langle \frac{1}{n}, 0 \rangle$, $n = 1, 2, 3, \dots$. Show that (X, \mathcal{T}) is connected but not locally connected.

(iv) Prove that every open subset of a locally connected space is locally connected.

(v) Let $(X_1, \mathcal{T}_1), (X_2, \mathcal{T}_2), \dots, (X_n, \mathcal{T}_n)$ be topological spaces. Prove that $\prod_{i=1}^n (X_i, \mathcal{T}_i)$ is locally connected if and only if each (X_i, \mathcal{T}_i) is locally connected.

6. Let A and B be connected subsets of a topological space (X, \mathcal{T}) such that $A \cap B \neq \emptyset$.

(i) If $(X, \mathcal{T}) = \mathbb{R}$, prove that $A \cap B$ is connected.

(ii) If $(X, \mathcal{T}) = \mathbb{R}^2$, is $A \cap B$ necessarily connected?

8.5 Fundamental Theorem of Algebra

In this section we give an application of topology to another branch of mathematics. We show how to use compactness and the [Generalized Heine-Borel Theorem 8.3.3](#) to prove the Fundamental Theorem of Algebra. (See also [Section 13.2.](#))

8.5.1 Theorem. (The Fundamental Theorem of Algebra) Every polynomial $f(z) = a_n z^n + a_{n-1} z^{n-1} + \cdots + a_1 z + a_0$, where each a_i is a complex number, $a_n \neq 0$, and $n \geq 1$, has a root; that is, there exists a complex number z_0 such that $f(z_0) = 0$.

Proof.

$$\begin{aligned}
 |f(z)| &= |a_n z^n + a_{n-1} z^{n-1} + \cdots + a_0| \\
 &\geq |a_n| |z|^n - |z|^{n-1} \left[|a_{n-1}| + \frac{|a_{n-2}|}{|z|} + \cdots + \frac{|a_0|}{|z|^{n-1}} \right] \\
 &\geq |a_n| |z|^n - |z|^{n-1} [|a_{n-1}| + |a_{n-2}| + \cdots + |a_0|], \quad \text{for } |z| \geq 1 \\
 &= |z|^{n-1} [|a_n| |z| - R], \quad \text{for } |z| \geq 1 \text{ and } R = |a_{n-1}| + \cdots + |a_0| \\
 &\geq |z|^{n-1}, \quad \text{for } |z| \geq \max \left\{ 1, \frac{R+1}{|a_n|} \right\}. \tag{1}
 \end{aligned}$$

If we put $p_0 = |f(0)| = |a_0|$ then, by inequality (1), there exists a $T > 0$ such that

$$|f(z)| > p_0, \quad \text{for all } |z| > T \tag{2}$$

Consider the set $D = \{z : z \in \text{complex plane and } |z| \leq T\}$. This is a closed bounded subset of the complex plane $\mathbb{C} = \mathbb{R}^2$ and so, by the [Generalized Heine-Borel Theorem](#), is compact. Therefore, by [Proposition 7.2.14](#), the continuous function $|f| : D \rightarrow \mathbb{R}$ has a least value at some point z_0 . So

$$|f(z_0)| \leq |f(z)|, \quad \text{for all } z \in D.$$

By (2), for all $z \notin D$, $|f(z)| > p_0 = |f(0)| \geq |f(z_0)|$. Therefore

$$|f(z_0)| \leq |f(z)|, \quad \text{for all } z \in \mathbb{C} \tag{3}$$

So we are required to prove that $f(z_0) = 0$. To do this it is convenient to perform a 'translation'. Put $P(z) = f(z + z_0)$. Then, by (2),

$$|P(0)| \leq |P(z)|, \quad \text{for all } z \in \mathbb{C} \tag{4}$$

The problem of showing that $f(z_0) = 0$ is now converted to the equivalent one of proving that $P(0) = 0$.

Now $P(z) = b_n z^n + b_{n-1} z^{n-1} \cdots + b_0$, $b_i \in \mathbb{C}$. So $P(0) = b_0$. We shall show that $b_0 = 0$.

Suppose $b_0 \neq 0$. Then

$$P(z) = b_0 + b_k z^k + z^{k+1} Q(z), \quad (5)$$

where $Q(z)$ is a polynomial and k is the smallest $i > 0$ with $b_i \neq 0$.

e.g. if $P(z) = 10z^7 + 6z^5 + 3z^4 + 4z^3 + 2z^2 + 1$, then $b_0 = 1$, $b_k = 2$, ($b_1 = 0$),
and

$$P(z) = 1 + 2z^2 + z^3 \overbrace{(4 + 3z + 6z^2 + 10z^4)}^{Q(z)}.$$

Let $w \in \mathbb{C}$ be a k^{th} root of the number $-b_0/b_k$; that is, $w^k = -b_0/b_k$.

As $Q(z)$ is a polynomial, for t a real number,

$$t |Q(tw)| \rightarrow 0, \quad \text{as } t \rightarrow 0$$

This implies that $t |w^{k+1} Q(tw)| \rightarrow 0$ as $t \rightarrow 0$.

So there exists a real number t_0 with $0 < t_0 < 1$ such that

$$t_0 |w^{k+1} Q(t_0 w)| < |b_0| \quad (6)$$

$$\begin{aligned} \text{So, by (5), } P(t_0 w) &= b_0 + b_k (t_0 w)^k + (t_0 w)^{k+1} Q(t_0 w) \\ &= b_0 + b_k \left[t_0^k \left(\frac{-b_0}{b_k} \right) \right] + (t_0 w)^{k+1} Q(t_0 w) \\ &= b_0 (1 - t_0^k) + (t_0 w)^{k+1} Q(t_0 w) \end{aligned}$$

$$\begin{aligned} \text{Therefore } |P(t_0 w)| &\leq (1 - t_0^k) |b_0| + t_0^{k+1} |w^{k+1} Q(t_0 w)| \\ &< (1 - t_0^k) |b_0| + t_0^k |b_0|, \quad \text{by (6)} \\ &= |b_0| \\ &= |P(0)| \end{aligned} \quad (7)$$

But (7) contradicts (4). Therefore the supposition that $b_0 \neq 0$ is false; that is, $P(0) = 0$, as required. \square

8.6 Postscript

As mentioned in the Introduction, this is one of three chapters devoted to product spaces. The easiest case is that of finite products. In the [next chapter](#) we study countably infinite products and in [Chapter 10](#), the general case. The most important result proved in this section is [Tychonoff's Theorem 8.3.1¹](#). In [Chapter 10](#) this is generalized to arbitrary sized products.

The second result we called a theorem here is the [Generalized Heine-Borel Theorem 8.3.3](#) which characterizes the compact subsets of \mathbb{R}^n as those which are closed and bounded.

[Exercises 8.3 #1](#) introduced the notion of locally compact topological space. Such spaces play a central role in topological group theory. (See [Appendix 5](#).)

Our study of connectedness has been furthered in this section by defining the component of a point. This allows us to partition any topological space into connected sets. In a connected space like \mathbb{R}^n the component of any point is the whole space. At the other end of the scale, the components in any totally disconnected space, for example, \mathbb{Q} , are all singleton sets.

As mentioned above, compactness has a local version. So too does connectedness. [Exercises 8.4 #5](#) defined locally connected. However, while every compact space is locally compact, not every connected space is locally connected. Indeed many properties \mathcal{P} have local versions called **locally \mathcal{P}** , and \mathcal{P} usually does not imply locally \mathcal{P} and locally \mathcal{P} usually does not imply \mathcal{P} .

Towards the end of the chapter we gave a topological proof of the [Fundamental Theorem of Algebra 8.5.1](#). The fact that a theorem in one branch of mathematics can be proved using methods from another branch is but one indication of why mathematics should not be compartmentalized. While you may have separate courses on algebra, complex analysis, and number theory these topics are, in fact, interrelated.

In [Appendix 5](#) we introduce the notion of a topological group, that is a set with the structure of both a topological space and a group, and with the two structures related in an appropriate manner. Topological group theory is a rich and interesting

¹You should have noticed how sparingly we use the word “theorem”, so when we do use that term it is because the result is important.

branch of mathematics. [Appendix 5](#) can be studied using the prerequisite knowledge in this chapter.

For those who know some category theory, we observe that the category of topological spaces and continuous mappings has both products and coproducts. The products in the category are indeed the products of the topological spaces. You may care to identify the coproducts.

Chapter 9

Countable Products

Introduction

Intuition tells us that a curve has zero area. Thus you should be astonished to learn of the existence of space-filling curves. We attack this topic using the curious space known as the Cantor Space. It is surprising that an examination of this space leads us to a better understanding of the properties of the unit interval $[0, 1]$.

Previously we have studied finite products of topological spaces. In this chapter we extend our study to countably infinite products of topological spaces. This leads us into wonderfully rich territory of which space-filling curves is but one example.

9.1 The Cantor Set

9.1.1 Remark. We now construct a very curious (but useful) set known as the Cantor Set. Consider the closed unit interval $[0,1]$ and delete from it the open interval $(\frac{1}{3}, \frac{2}{3})$, which is the middle third, and denote the remaining closed set by G_1 . So

$$G_1 = [0, \frac{1}{3}] \cup [\frac{2}{3}, 1].$$

Next, delete from G_1 the open intervals $(\frac{1}{9}, \frac{2}{9})$ and $(\frac{7}{9}, \frac{8}{9})$ which are the middle third of its two pieces and denote the remaining closed set by G_2 . So

$$G_2 = [0, \frac{1}{9}] \cup [\frac{2}{9}, \frac{1}{3}] \cup [\frac{2}{3}, \frac{7}{9}] \cup [\frac{8}{9}, 1].$$

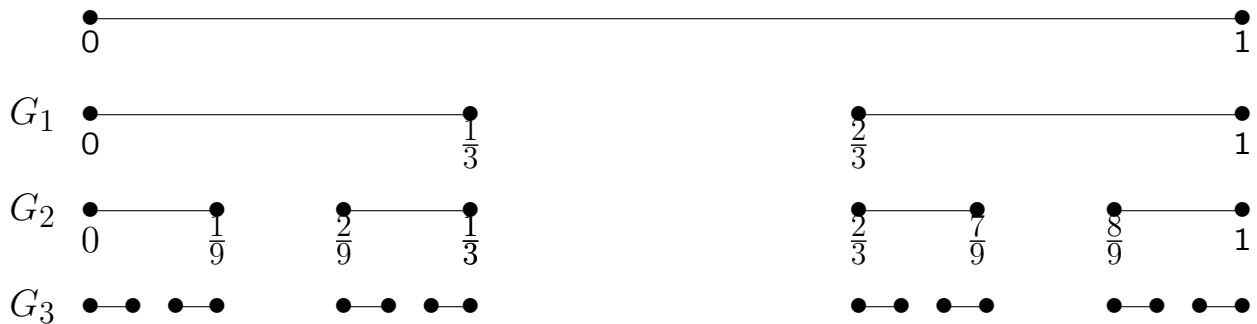

If we continue in this way, at each stage deleting the open middle third of each closed interval remaining from the previous stage we obtain a descending sequence of closed sets

$$G_1 \supset G_2 \supset G_3 \supset \dots G_n \supset \dots$$

The **Cantor Set**, G , is defined by

$$G = \bigcap_{n=1}^{\infty} G_n$$

and, being the intersection of closed sets, is a closed subset of $[0,1]$. As $[0,1]$ is compact, the **Cantor Space**, (G, \mathcal{T}) , (that is, G with the subspace topology) is compact. [The Cantor Set is named after the famous set theorist, Georg Cantor (1845–1918).]

It is useful to represent the Cantor Set in terms of real numbers written to base 3; that is, ternaries. You are familiar with the decimal expansion of real numbers which uses base 10. Today one cannot avoid computers which use base 2. But for the Cantor Set, base 3 is what is best.

In the ternary system, $76\frac{5}{81}$ would be written as 2211·0012, since this represents

$$2 \cdot 3^3 + 2 \cdot 3^2 + 1 \cdot 3^1 + 1 \cdot 3^0 + 0 \cdot 3^{-1} + 0 \cdot 3^{-2} + 1 \cdot 3^{-3} + 2 \cdot 3^{-4}.$$

So a number x in $[0, 1]$ is represented by the base 3 number $\cdot a_1 a_2 a_3 \dots a_n \dots$, where

$$x = \sum_{n=1}^{\infty} \frac{a_n}{3^n}, \quad a_n \in \{0, 1, 2\}, \quad \text{for each } n \in \mathbb{N}.$$

So as $\frac{1}{2} = \sum_{n=1}^{\infty} \frac{1}{3^n}$, $\frac{1}{3} = \sum_{n=2}^{\infty} \frac{2}{3^n}$, and $1 = \sum_{n=1}^{\infty} \frac{2}{3^n}$, we see that their ternary forms are given by

$$\frac{1}{2} = 0.11111\dots; \quad \frac{1}{3} = 0.02222\dots; \quad 1 = 0.2222\dots$$

(Of course another ternary expression for $\frac{1}{3}$ is 0.10000... and another for 1 is 1.0000....)

Turning again to the Cantor Set, G , it should be clear that an element of $[0, 1]$ is in G if and only if it can be written in ternary form with $a_n \neq 1$, for every $n \in \mathbb{N}$. So $\frac{1}{2} \notin G$, $\frac{5}{81} \notin G$, $\frac{1}{3} \in G$, and $1 \in G$.

Thus we have a function f from the Cantor Set into the set of all sequences of the form $\langle a_1, a_2, a_3, \dots, a_n, \dots \rangle$, where each $a_i \in \{0, 2\}$ and f is one-to-one and onto. Later on we shall make use of this function f . \square

Exercises 9.1

1. (a) Write down ternary expansions for the following numbers:

(i) $21\frac{5}{243}$; (ii) $\frac{7}{9}$; (iii) $\frac{1}{13}$.

(b) Which real numbers have the following ternary expressions:

(i) $0.\overline{02} = 0.020202\dots$; (ii) $0.\overline{110}$; (iii) $0.\overline{012}$?

(c) Which of the numbers appearing in (a) and (b) lie in the Cantor Set?

2. Let x be a point in a topological space (X, \mathcal{T}) . Then x is said to be an **isolated point** if $x \in X \setminus X'$; that is, x is not a limit point of X . The space (X, \mathcal{T}) is said to be **perfect** if it has no isolated points. Prove that the Cantor Space is a compact totally disconnected perfect space.

[It can be shown that any non-empty compact totally disconnected metrizable perfect space is homeomorphic to the Cantor Space. See, for example, Exercise 6.2A(c) of Engelking [130].

9.2 The Product Topology

9.2.1 Definition. Let $(X_1, \mathcal{T}_1), (X_2, \mathcal{T}_2), \dots, (X_n, \mathcal{T}_n), \dots$ be a countably infinite family of topological spaces. Then the **product**, $\prod_{i=1}^{\infty} X_i$, of the sets $X_i, i \in \mathbb{N}$ consists of all the infinite sequences $\langle x_1, x_2, x_3, \dots, x_n, \dots \rangle$, where $x_i \in X_i$ for all i . (The infinite sequence $\langle x_1, x_2, \dots, x_n, \dots \rangle$ is sometimes written as $\prod_{i=1}^{\infty} x_i$.) The **product space**, $\prod_{i=1}^{\infty} (X_i, \mathcal{T}_i)$, consists of the product $\prod_{i=1}^{\infty} X_i$ with the topology \mathcal{T} having as its basis the family

$$B = \left\{ \prod_{i=1}^{\infty} O_i : O_i \in \mathcal{T}_i \text{ and } O_i = X_i \text{ for all but a finite number of } i. \right\}$$

The topology \mathcal{T} is called the **product topology**.

So a basic open set is of the form

$$O_1 \times O_2 \times \cdots \times O_n \times X_{n+1} \times X_{n+2} \times \cdots$$

Warning. It should be obvious that **a product of open sets need not be open in the product topology \mathcal{T}** . In particular, if $O_1, O_2, O_3, \dots, O_n, \dots$ are such that each $O_i \in \mathcal{T}_i$, and $O_i \neq X_i$ for all i , then $\prod_{i=1}^{\infty} O_i$ cannot be expressed as a union of members of \mathcal{B} and so is not open in the product space $(\prod_{i=1}^{\infty} X_i, \mathcal{T})$.

9.2.2 Remark. Why do we choose to define the product topology as in Definition 9.2.1? The answer is that only with this definition do we obtain Tychonoff's Theorem (for infinite products), which says that any product of compact spaces is compact. And this result is extremely important for applications.

9.2.3 Example. Let $(X_1, \mathcal{T}_1), \dots, (X_n, \mathcal{T}_n), \dots$ be a countably infinite family of topological spaces. Then the **box topology** \mathcal{T}' on the product $\prod_{i=1}^{\infty} X_i$, is that topology having as its basis the family

$$B' = \left\{ \prod_{i=1}^{\infty} O_i : O_i \in \mathcal{T}_i \right\}.$$

It is readily seen that if each (X_i, \mathcal{T}_i) is a discrete space, then the box product $(\prod_{i=1}^{\infty} X_i, \mathcal{T}')$ is a discrete space. So if each (X_i, \mathcal{T}) is a finite set with the discrete topology, then $(\prod_{i=1}^{\infty} X_i, \mathcal{T}')$ is an infinite discrete space, which is certainly not compact. So we have a box product of the compact spaces (X_i, \mathcal{T}_i) being a non-compact space. \square

Another justification for our choice of definition of the product topology is the next proposition which is the analogue for countably infinite products of Proposition 8.2.5.

9.2.4 Proposition. Let $(X_1, \mathcal{T}_1), (X_2, \mathcal{T}_2), \dots, (X_n, \mathcal{T}_n), \dots$ be a countably infinite family of topological spaces and $(\prod_{i=1}^{\infty} X_i, \mathcal{T})$ their product space. For each i , let $p_i: \prod_{j=1}^{\infty} X_j \rightarrow X_i$ be the projection mapping; that is $p_i(\langle x_1, x_2, \dots, x_n, \dots \rangle) = x_i$ for each $\langle x_1, x_2, \dots, x_n, \dots \rangle \in \prod_{j=1}^{\infty} X_j$. Then

- (i) each p_i is a continuous surjective open mapping, and
- (ii) \mathcal{T} is the coarsest topology on the set $\prod_{j=1}^{\infty} X_j$ such that each p_i is continuous.

Proof. The proof is analogous to that of [Proposition 8.2.5](#) and so left as an exercise. \square

We shall use the next proposition a little later.

9.2.5 Proposition. Let (X_i, \mathcal{T}_i) and (Y_i, \mathcal{T}'_i) , $i \in \mathbb{N}$, be countably infinite families of topological spaces having product spaces $(\prod_{i=1}^{\infty} X_i, \mathcal{T})$ and $(\prod_{i=1}^{\infty} Y_i, \mathcal{T}')$, respectively. If the mapping $h_i: (X_i, \mathcal{T}_i) \rightarrow (Y_i, \mathcal{T}'_i)$ is continuous for each $i \in \mathbb{N}$, then so is the mapping $h: (\prod_{i=1}^{\infty} X_i, \mathcal{T}) \rightarrow (\prod_{i=1}^{\infty} Y_i, \mathcal{T}')$ given by $h: (\prod_{i=1}^{\infty} x_i) = \prod_{i=1}^{\infty} h_i(x_i)$; that is, $h(\langle x_1, x_2, \dots, x_n, \dots \rangle) = \langle h_1(x_1), h_2(x_2), \dots, h_n(x_n), \dots \rangle$.

Proof. It suffices to show that if O is a basic open set in $(\prod_{i=1}^{\infty} Y_i, \mathcal{T}')$, then $h^{-1}(O)$ is open in $(\prod_{i=1}^{\infty} X_i, \mathcal{T})$. Consider the basic open set $U_1 \times U_2 \times \dots \times U_n \times Y_{n+1} Y_{n+2} \times \dots$ where $U_i \in \mathcal{T}'_i$, for $i = 1, \dots, n$. Then

$$h^{-1}(U_1 \times \dots \times U_n \times Y_{n+1} \times Y_{n+2} \times \dots) = h_1^{-1}(U_1) \times \dots \times h_n^{-1}(U_n) \times X_{n+1} \times X_{n+2} \times \dots$$

and the set on the right hand side is in \mathcal{T} , since the continuity of each h_i implies $h_i^{-1}(U_i) \in \mathcal{T}_i$, for $i = 1, \dots, n$. So h is continuous. \square

Exercises 9.2

1. For each $i \in \mathbb{N}$, let C_i be a closed subset of a topological space (X_i, \mathcal{T}_i) . Prove that $\prod_{i=1}^{\infty} C_i$ is a closed subset of $\prod_{i=1}^{\infty} (X_i, \mathcal{T}_i)$.

2. If in [Proposition 9.2.5](#) each mapping h_i is also
- one-to-one,
 - onto,
 - onto and open,
 - a homeomorphism,
- prove that h is respectively
- one-to-one,
 - onto,
 - onto and open,
 - a homeomorphism.
3. Let (X_i, \mathcal{T}_i) , $i \in \mathbb{N}$, be a countably infinite family of topological spaces. Prove that each (X_i, \mathcal{T}_i) is homeomorphic to a subspace of $\prod_{i=1}^{\infty} (X_i, \mathcal{T}_i)$.
[Hint: See [Proposition 8.2.8](#)].
4. (a) Let (X_i, \mathcal{T}_i) , $i \in \mathbb{N}$, be topological spaces. If each (X_i, \mathcal{T}_i) is (i) a Hausdorff space, (ii) a T_1 -space, (iii) a T_0 -space, prove that $\prod_{i=1}^{\infty} (X_i, \mathcal{T}_i)$ is respectively (i) a Hausdorff space, (ii) a T_1 -space, (iii) a T_0 -space.
- (b) Using [Exercise 3 above](#), prove the converse of the statements in (a).
5. Let (X_i, \mathcal{T}_i) , $i \in \mathbb{N}$, be a countably infinite family of topological spaces. Prove that $\prod_{i=1}^{\infty} (X_i, \mathcal{T}_i)$ is a discrete space if and only if each (X_i, \mathcal{T}_i) is discrete and all but a finite number of the X_i , $i \in \mathbb{N}$ are singleton sets.
6. For each $i \in \mathbb{N}$, let (X_i, \mathcal{T}_i) be a topological space. Prove that
- if $\prod_{i=1}^{\infty} (X_i, \mathcal{T}_i)$ is compact, then each (X_i, \mathcal{T}_i) is compact;
 - if $\prod_{i=1}^{\infty} (X_i, \mathcal{T}_i)$ is connected, then each (X_i, \mathcal{T}_i) is connected;
 - if $\prod_{i=1}^{\infty} (X_i, \mathcal{T}_i)$ is locally compact, then each (X_i, \mathcal{T}_i) is locally compact and all but a finite number of (X_i, \mathcal{T}_i) are compact.

9.3 The Cantor Space and the Hilbert Cube

9.3.1 Remark. We now return to the Cantor Space and prove that it is homeomorphic to a countably infinite product of two-point spaces.

For each $i \in \mathbb{N}$ we let (A_i, \mathcal{T}_i) be the set $\{0, 2\}$ with the discrete topology, and consider the product space $(\prod_{i=1}^{\infty} A_i, \mathcal{T}')$. We show in the next proposition that it is homeomorphic to the Cantor Space (G, \mathcal{T}) .

9.3.2 Proposition. Let (G, \mathcal{T}) be the Cantor Space and $(\prod_{i=1}^{\infty} A_i, \mathcal{T}')$ be as in [Remark 9.3.1](#). Then the map $f: (G, \mathcal{T}) \rightarrow (\prod_{i=1}^{\infty} A_i, \mathcal{T}')$ given by $f(\sum_{n=1}^{\infty} \frac{a_n}{3^n}) = \langle a_1, a_2, \dots, a_n, \dots \rangle$ is a homeomorphism.

Proof. We have already noted in [Remark 9.1.1](#) that f is one-to-one and onto. As (G, \mathcal{T}) is compact and $(\prod_{i=1}^{\infty} A_i, \mathcal{T}')$ is Hausdorff ([Exercises 9.2 #4](#)) [Exercises 7.2 #6](#) says that f is a homeomorphism if it is continuous.

To prove the continuity of f it suffices to show for any basic open set $U = U_1 \times U_2 \times \dots \times U_N \times A_{N+1} \times A_{N+2} \times \dots$ and any $a = \langle a_1, a_2, \dots, a_n, \dots \rangle \in U$ there exists an open set $W \ni \sum_{n=1}^{\infty} \frac{a_n}{3^n}$ such that $f(W) \subseteq U$.

Consider the open interval $(\sum_{n=1}^{\infty} \frac{a_n}{3^n} - \frac{1}{3^{N+2}}, \sum_{n=1}^{\infty} \frac{a_n}{3^n} + \frac{1}{3^{N+2}})$ and let W be the intersection of this open interval with G . Then W is open in (G, \mathcal{T}) and if $x = \sum_{n=1}^{\infty} \frac{x_n}{3^n} \in W$, then $x_i = a_i$, for $i = 1, 2, \dots, N$.

So $f(x) \in U_1 \times U_2 \times \dots \times U_N \times A_{N+1} \times A_{N+2} \times \dots$, and thus $f(W) \subseteq U$, as required. \square

As indicated earlier, we shall in due course prove that any product of compact spaces is compact – that is, Tychonoff's Theorem. However in view of [Proposition 9.3.2](#) we can show, trivially, that the product of a countable number of homeomorphic copies of the Cantor Space is homeomorphic to the Cantor Space, and hence is compact.

9.3.3 Proposition. Let (G_i, \mathcal{T}_i) , $i \in \mathbb{N}$, be a countably infinite family of topological spaces each of which is homeomorphic to the Cantor Space (G, \mathcal{T}) . Then

$$(G, \mathcal{T}) \cong \prod_{i=1}^{\infty} (G_i, \mathcal{T}_i) \cong \prod_{i=1}^n (G_i, \mathcal{T}_i), \quad \text{for each } n \in \mathbb{N}.$$

Proof. Firstly we verify that $(G, \mathcal{T}) \cong (G_1, \mathcal{T}_1) \times (G_2, \mathcal{T}_2)$. This is, by virtue of [Proposition 9.3.2](#), equivalent to showing that

$$\prod_{i=1}^{\infty} (A_i, \mathcal{T}_i) \cong \prod_{i=1}^{\infty} (A_i, \mathcal{T}_i) \times \prod_{i=1}^{\infty} (A_i, \mathcal{T}_i)$$

where each (A_i, \mathcal{T}_i) is the set $\{0, 2\}$ with the discrete topology.

Now we define a function θ from the set $\prod_{i=1}^{\infty} (A_i, \mathcal{T}_i) \times \prod_{i=1}^{\infty} (A_i, \mathcal{T}_i)$ to the set $\prod_{i=1}^{\infty} (A_i, \mathcal{T}_i)$ by

$$\theta(\langle a_1, a_2, a_3, \dots \rangle, \langle b_1, b_2, b_3, \dots \rangle) \longrightarrow \langle a_1, b_1, a_2, b_2, a_3, b_3, \dots \rangle$$

It is readily verified that θ is a homeomorphism and so $(G_1, \mathcal{T}_1) \times (G_2, \mathcal{T}_2) \cong (G, \mathcal{T})$. By induction, then, $(G, \mathcal{T}) \cong \prod_{i=1}^n (G_i, \mathcal{T}_i)$, for every positive integer n .

Turning to the infinite product case, define the mapping

$$\begin{aligned} \phi : \left[\prod_{i=1}^{\infty} (A_i, \mathcal{T}_i) \times \prod_{i=1}^{\infty} (A_i, \mathcal{T}_i) \times \prod_{i=1}^{\infty} (A_i, \mathcal{T}_i) \times \dots \right] &\longrightarrow \prod_{i=1}^{\infty} (A_i, \mathcal{T}_i) \\ \text{by } \phi(\langle a_1, a_2, \dots \rangle, \langle b_1, b_2, \dots \rangle, \langle c_1, c_2, \dots \rangle, \langle d_1, d_2, \dots \rangle, \langle e_1, e_2, \dots \rangle, \dots) & \\ = \langle a_1, a_2, b_1, a_3, b_2, c_1, a_4, b_3, c_2, d_1, a_5, b_4, c_3, d_2, e_1, \dots \rangle. & \end{aligned}$$

Again it is easily verified that ϕ is a homeomorphism, and the proof is complete. \square

9.3.4 Remark. It should be observed that the statement

$$(G, \mathcal{T}) \cong \prod_{i=1}^{\infty} (G_i, \mathcal{T}_i)$$

in [Proposition 9.3.3](#) is perhaps more transparent if we write it as

$$(A, \mathcal{T}) \times (A, \mathcal{T}) \times \dots \cong [(A, \mathcal{T}) \times (A, \mathcal{T}) \times \dots] \times [(A, \mathcal{T}) \times (A, \mathcal{T}) \times \dots] \times \dots$$

where (A, \mathcal{T}) is the set $\{0, 2\}$ with the discrete topology. \square

9.3.5 Proposition. The topological space $[0, 1]$ is a continuous image of the Cantor Space (G, \mathcal{T}) .

Proof. In view of [Proposition 9.3.2](#) it suffices to find a continuous mapping ϕ of $\prod_{i=1}^{\infty} (A_i, \mathcal{T}_i)$ onto $[0, 1]$. Such a mapping is given by

$$\phi(\langle a_1, a_2, \dots, a_i, \dots \rangle) = \sum_{i=1}^{\infty} \frac{a_i}{2^{i+1}}.$$

Recalling that each $a_i \in \{0, 2\}$ and that each number $x \in [0, 1]$ has a dyadic expansion of the form $\sum_{j=1}^{\infty} \frac{b_j}{2^j}$, where $b_j \in \{0, 1\}$, we see that ϕ is an onto mapping. To show that ϕ is continuous it suffices, by [Proposition 5.1.7](#), to verify that if U is the open interval

$$\left(\sum_{i=1}^{\infty} \frac{a_i}{2^{i+1}} - \varepsilon, \sum_{i=1}^{\infty} \frac{a_i}{2^{i+1}} + \varepsilon \right) \ni \sum_{i=1}^{\infty} \frac{a_i}{2^{i+1}}, \quad \text{for any } \varepsilon > 0.$$

then there exists an open set $W \ni \langle a_1, a_2, \dots, a_i, \dots \rangle$ such that $\phi(W) \subseteq U$. Choose N sufficiently large that $\sum_{i=N}^{\infty} \frac{a_i}{2^{i+1}} < \varepsilon$, and put

$$W = \{a_1\} \times \{a_2\} \times \dots \times \{a_N\} \times A_{N+1} \times A_{N+2} \times \dots$$

Then W is open in $\prod_{i=1}^{\infty} (A_i, \mathcal{T}_i)$, $W \ni \langle a_1, a_2, \dots, a_i, \dots \rangle$, and $\phi(W) \subseteq U$, as required. \square

9.3.6 Remark. You should be somewhat surprised by [Proposition 9.3.5](#) as it says that the “nice” space $[0, 1]$ is a continuous image of the very curious Cantor Space. However, we shall see in due course that every compact metric space is a continuous image of the Cantor Space. \square

9.3.7 Definition. For each positive integer n , let the topological space (I_n, \mathcal{T}_n) be homeomorphic to $[0, 1]$. Then the product space $\prod_{n=1}^{\infty} (I_n, \mathcal{T}_n)$ is called the **Hilbert cube** and is denoted by I^{∞} . The product space $\prod_{i=1}^n (I_i, \mathcal{T}_i)$ is called the **n-cube** and is denoted by I^n , for each $n \in \mathbb{N}$.

We know from [Tychonoff's Theorem 8.3.1 for finite products](#) that I^n is compact for each n . We now prove that I^∞ is compact. (Of course this result can also be deduced from [Tychonoff's Theorem 10.3.4 for infinite products](#), which is proved in [Chapter 10](#).)

9.3.8 Theorem. The Hilbert cube is compact.

Proof. By [Proposition 9.3.5](#), there is a continuous mapping ϕ_n of (G_n, \mathcal{T}_n) onto (I_n, \mathcal{T}'_n) where, for each $n \in \mathbb{N}$, (G_n, \mathcal{T}_n) and (I_n, \mathcal{T}'_n) are homeomorphic to the Cantor Space and $[0,1]$, respectively. Therefore by [Proposition 9.2.5](#) and [Exercises 9.2 #2 \(b\)](#), there is a continuous mapping ψ of $\prod_{n=1}^{\infty} (G_n, \mathcal{T}_n)$ onto $\prod_{n=1}^{\infty} (I_n, \mathcal{T}'_n) = I^\infty$. But [Proposition 9.3.3](#) says that $\prod_{n=1}^{\infty} (G_n, \mathcal{T}_n)$ is homeomorphic to the Cantor Space (G, \mathcal{T}) . Therefore I^∞ is a continuous image of the compact space (G, \mathcal{T}) , and hence is compact. \square

9.3.9 Proposition. Let (X_i, \mathcal{T}_i) , $i \in \mathbb{N}$, be a countably infinite family of metrizable spaces. Then $\prod_{i=1}^{\infty} (X_i, \mathcal{T}_i)$ is metrizable.

Proof. For each $i \in \mathbb{N}$, let d_i be a metric on X_i which induces the topology \mathcal{T}_i . Exercises 6.1 #2 says that if we put $e_i(a, b) = \min(1, d_i(a, b))$, for all a and b in X_i , then e_i is a metric and it induces the topology \mathcal{T}_i on X_i . So we can, without loss of generality, assume that $d_i(a, b) \leq 1$, for all a and b in X_i , $i \in \mathbb{N}$.

Define $d: \prod_{i=1}^{\infty} X_i \times \prod_{i=1}^{\infty} X_i \rightarrow \mathbb{R}$ by

$$d\left(\prod_{i=1}^{\infty} a_i, \prod_{i=1}^{\infty} b_i\right) = \sum_{i=1}^{\infty} \frac{d_i(a_i, b_i)}{2^i} \text{ for all } a_i \text{ and } b_i \text{ in } X_i.$$

Observe that the series on the right hand side converges because each $d_i(a_i, b_i) \leq 1$ and so it is bounded above by $\sum_{i=1}^{\infty} \frac{1}{2^i} = 1$.

It is easily verified that d is a metric on $\prod_{i=1}^{\infty} X_i$. Observe that d'_i , defined by $d'_i(a, b) = \frac{d_i(a, b)}{2^i}$, is a metric on X_i , which induces the same topology \mathcal{T}_i as d_i . We claim that d induces the product topology on $\prod_{i=1}^{\infty} X_i$.

To see this consider the following. Since

$$d\left(\prod_{i=1}^{\infty} a_i, \prod_{i=1}^{\infty} b_i\right) \geq \frac{d_i(a_i, b_i)}{2^i} = d'_i(a_i, b_i)$$

it follows that the projection $p_i: (\prod_{i=1}^{\infty} X_i, d) \rightarrow (X_i, d'_i)$ is continuous, for each i . As d'_i induces the topology \mathcal{T}'_i , Proposition 9.2.4 (ii) implies that the topology induced on $\prod_{i=1}^{\infty} X_i$ by d is finer than the product topology.

To prove that the topology induced by d is also coarser than the product topology, let $B_{\varepsilon}(a)$ be any open ball of radius $\varepsilon > 0$ about a point $a = \prod_{i=1}^{\infty} a_i$. So $B_{\varepsilon}(a)$ is a basic open set in the topology induced by d . We have to show that there is a set $W \ni a$ such that $W \subseteq B_{\varepsilon}(a)$, and W is open in the product topology. Let N be a positive integer such that $\sum_{i=N}^{\infty} \frac{1}{2^i} < \frac{\varepsilon}{2}$. Let O_i be the open ball in (X_i, d_i) of radius $\frac{\varepsilon}{2N}$ about the point a_i , $i = 1, \dots, N$. Define

$$W = O_1 \times O_2 \times \cdots \times O_N \times X_{N+1} \times X_{N+2} \times \cdots$$

Then W is an open set in the product topology, $a \in W$, and clearly $W \subseteq B_{\varepsilon}(a)$, as required. \square

9.3.10 Corollary. The Hilbert Cube is metrizable. \square

The proof of [Proposition 9.3.9](#) can be refined to obtain the following result:

9.3.11 Proposition. Let (X_i, \mathcal{T}_i) , $i \in \mathbb{N}$, be a countably infinite family of completely metrizable spaces. Then $\prod_{i=1}^{\infty} (X_i, \mathcal{T}_i)$ is completely metrizable.

Proof. [Exercises 9.3 #10](#). \square

9.3.12 Remark. From [Proposition 9.3.11](#) we see that a countably infinite product of discrete spaces is completely metrizable. The most interesting example of this is \mathbb{N}^{\aleph_0} , that is a countably infinite product of topological spaces each homeomorphic to the discrete space \mathbb{N} . What is much more surprising is the fact, as mentioned in Chapter 6, that \mathbb{N}^{∞} is homeomorphic to \mathbb{P} , the topological space of all irrational numbers with the euclidean topology. See Engelking [130] Exercise 4.3.G and Exercise 6.2.A.

9.3.13 Remark. Another important example of a completely metrizable countable product is \mathbb{R}^{∞} . This is the countably infinite product of topological spaces each homeomorphic to \mathbb{R} . Corollary 4.3.25 of Engelking [130] shows that: **a separable metrizable space is completely metrizable if and only if it is homeomorphic to a closed subspace of \mathbb{R}^{∞} .** In particular we see that **every separable Banach space is homeomorphic to a closed subspace of \mathbb{R}^{∞} .**

A beautiful and deep result says that: **every separable infinite-dimensional Banach space is homeomorphic to \mathbb{R}^{∞} ,** see Bessaga and Pelczynski [41].

Exercises 9.3

1. Let (X_i, d_i) , $i \in \mathbb{N}$, be a countably infinite family of metric spaces with the property that, for each i , $d_i(a, b) \leq 1$, for all a and b in X_i . Define $e : \prod_{i=1}^{\infty} X_i \times \prod_{i=1}^{\infty} X_i \rightarrow \mathbb{R}$ by

$$e \left(\prod_{i=1}^{\infty} a_i, \prod_{i=1}^{\infty} b_i \right) = \sup \{ d_i(a_i, b_i) : i \in \mathbb{N} \}.$$

Prove that e is a metric on $\prod_{i=1}^{\infty} X_i$ and is equivalent to the metric d in [Proposition 9.3.9](#). (Recall that “equivalent” means “induces the same topology”.)

2. If (X_i, \mathcal{T}_i) , $i \in \mathbb{N}$, are compact subspaces of $[0, 1]$, deduce from [Theorem 9.3.8](#) and [Exercises 9.2 #1](#), that $\prod_{i=1}^{\infty} (X_i, \mathcal{T}_i)$ is compact.
3. Let $\prod_{i=1}^{\infty} (X_i, \mathcal{T}_i)$ be the product of a countably infinite family of topological spaces. Let (Y, \mathcal{T}) be a topological space and f a mapping of (Y, \mathcal{T}) into $\prod_{i=1}^{\infty} (X_i, \mathcal{T}_i)$. Prove that f is continuous if and only if each mapping $p_i \circ f : (Y, \mathcal{T}) \rightarrow (X_i, \mathcal{T}_i)$ is continuous, where p_i denotes the projection mapping.
4. (a) Let X be a finite set and \mathcal{T} a Hausdorff topology on X . Prove that
 (i) \mathcal{T} is the discrete topology;
 (ii) (X, \mathcal{T}) is homeomorphic to a subspace of $[0, 1]$.
 (b) Using (a) and [Exercise 3 above](#), prove that if (X_i, \mathcal{T}_i) is a finite Hausdorff space for $i \in \mathbb{N}$, then $\prod_{i=1}^{\infty} (X_i, \mathcal{T}_i)$ is compact and metrizable.
 (c) Show that every finite topological space is a continuous image of a finite discrete space.
 (d) Using (b) and (c), prove that if (X_i, \mathcal{T}_i) is a finite topological space for each $i \in \mathbb{N}$, then $\prod_{i=1}^{\infty} (X_i, \mathcal{T}_i)$ is compact.
5. (i) Prove that the Sierpinski Space ([Exercises 1.3 #5 \(iii\)](#)) is a continuous image of $[0, 1]$.
 (ii) Using (i) and [Proposition 9.2.5](#), show that if (X_i, \mathcal{T}_i) , for each $i \in \mathbb{N}$, is homeomorphic to the Sierpinski Space, then $\prod_{i=1}^{\infty} (X_i, \mathcal{T}_i)$ is compact.

6. (i) Let (X_i, \mathcal{T}_i) , $i \in \mathbb{N}$, be a countably infinite family of topological spaces each

of which satisfies the second axiom of countability. Prove that $\prod_{i=1}^{\infty} (X_i, \mathcal{T}_i)$ satisfies the second axiom of countability.

(ii) Using [Exercises 3.2 #4 \(viii\)](#) and [Exercises 4.1 #14](#), deduce that the Hilbert cube and all of its subspaces are separable.

7. Let (X_i, \mathcal{T}_i) , $i \in \mathbb{N}$, be a countably infinite family of topological spaces. Prove that $\prod_{i=1}^{\infty} (X_i, \mathcal{T}_i)$ is a totally disconnected space if and only if each (X_i, \mathcal{T}_i) is totally disconnected. Deduce that the Cantor Space is totally disconnected.

8. Let (X, \mathcal{T}) be a topological space and $(X_{ij}, \mathcal{T}_{ij})$, $i \in \mathbb{N}$, $j \in \mathbb{N}$, a family of topological spaces each of which is homeomorphic to (X, \mathcal{T}) . Prove that

$$\prod_{j=1}^{\infty} \left(\prod_{i=1}^{\infty} (X_{ij}, \mathcal{T}_{ij}) \right) \cong \prod_{i=1}^{\infty} (X_{i1}, \mathcal{T}_{i1}).$$

[Hint: This result generalizes [Proposition 9.3.3](#) and the proof uses a map analogous to ϕ .]

9. (i) Let (X_i, \mathcal{T}_i) , $i \in \mathbb{N}$, be a countably infinite family of topological spaces each

of which is homeomorphic to the Hilbert cube. Deduce from [Exercise 8 above](#) that $\prod_{i=1}^{\infty} (X_i, \mathcal{T}_i)$ is homeomorphic to the Hilbert cube.

(ii) Hence show that if (X_i, \mathcal{T}_i) , $i \in \mathbb{N}$, are compact subspaces of the Hilbert cube, then $\prod_{i=1}^{\infty} (X_i, \mathcal{T}_i)$ is compact.

10. Prove [Proposition 9.3.11](#).

[Hint. In the notation of the proof of [Proposition 9.3.9](#), show that if $a_n = \prod_{i=1}^{\infty} a_{in}$, $n \in \mathbb{N}$, is a Cauchy sequence in $(\prod_{i=1}^{\infty} X_i, d)$, then for each $i \in \mathbb{N}$, $\{a_{in} : n \in \mathbb{N}\}$ is a Cauchy sequence in X_i, d_i .]

9.4 Urysohn's Theorem

9.4.1 Definition. A topological space (X, \mathcal{T}) is said to be **separable** if it has a countable dense subset.

See [Exercises 3.2 #4](#) and [Exercises 8.1 #9](#) where separable spaces were introduced.

9.4.2 Example. \mathbb{Q} is dense in \mathbb{R} , and so \mathbb{R} is separable. □

9.4.3 Example. Every countable topological space is separable. □

9.4.4 Proposition. Let (X, \mathcal{T}) be a compact metrizable space. Then (X, \mathcal{T}) is separable.

Proof. Let d be a metric on X which induces the topology \mathcal{T} . For each positive integer n , let \mathcal{S}_n be the family of all open balls having centres in X and radius $\frac{1}{n}$. Then \mathcal{S}_n is an open covering of X and so there is a finite subcovering $\mathcal{U}_n = \{U_{n_1}, U_{n_2}, \dots, U_{n_k}\}$, for some $k \in \mathbb{N}$. Let y_{n_j} be the centre of U_{n_j} , $j = 1, \dots, k$, and $Y_n = \{y_{n_1}, y_{n_2}, \dots, y_{n_k}\}$. Put $Y = \bigcup_{n=1}^{\infty} Y_n$. Then Y is a countable subset of X . We now show that Y is dense in (X, \mathcal{T}) .

If V is any non-empty open set in (X, \mathcal{T}) , then for any $v \in V$, V contains an open ball, B , of radius $\frac{1}{n}$, about v , for some $n \in \mathbb{N}$. As \mathcal{U}_n is an open cover of X , $v \in U_{n_j}$, for some j . Thus $d(v, y_{n_j}) < \frac{1}{n}$ and so $y_{n_j} \in B \subseteq V$. Hence $V \cap Y \neq \emptyset$, and so Y is dense in X . □

9.4.5 Corollary. The Hilbert cube is a separable space. □

Shortly we shall prove the very striking Urysohn Theorem which shows that every compact metrizable space is homeomorphic to a subspace of the Hilbert cube. En route we prove the (countable version of the) Embedding Lemma.

First we record the following proposition, which is [Exercises 9.3 #3](#) and so its proof is not included here.

9.4.6 Proposition. Let (X_i, \mathcal{T}_i) , $i \in \mathbb{N}$, be a countably infinite family of topological spaces and f a mapping of a topological space (Y, \mathcal{T}) into $\prod_{i=1}^{\infty} (X_i, \mathcal{T}_i)$. Then f is continuous if and only if each mapping $p_i \circ f: (Y, \mathcal{T}) \rightarrow (X_i, \mathcal{T}_i)$ is continuous, where p_i denotes the projection mapping of $\prod_{i=1}^{\infty} (X_i, \mathcal{T}_i)$ onto (X_i, \mathcal{T}_i) .

9.4.7 Lemma. (The Embedding Lemma) Let (Y_i, \mathcal{T}_i) , $i \in \mathbb{N}$, be a countably infinite family of topological spaces and for each i , let f_i be a mapping of a topological space (X, \mathcal{T}) into (Y_i, \mathcal{T}_i) . Further, let $e: (X, \mathcal{T}) \rightarrow \prod_{i=1}^{\infty} (Y_i, \mathcal{T}_i)$ be the **evaluation map**; that is, $e(x) = \prod_{i=1}^{\infty} f_i(x)$, for all $x \in X$. Then e is a homeomorphism of (X, \mathcal{T}) onto the space $(e(X), \mathcal{T}')$, where \mathcal{T}' is the subspace topology on $e(X)$, if

- (i) each f_i is continuous,
- (ii) the family $\{f_i : i \in \mathbb{N}\}$ **separates points** of X ; that is, if x_1 and x_2 are in X with $x_1 \neq x_2$, then for some i , $f_i(x_1) \neq f_i(x_2)$, and
- (iii) the family $\{f_i : i \in \mathbb{N}\}$ **separates points and closed sets**; that is, for $x \in X$ and A any closed subset of (X, \mathcal{T}) not containing x , $f_i(x) \notin \overline{f_i(A)}$, for some i .

Proof. That the mapping $e: (X, \mathcal{T}) \rightarrow (e(X), \mathcal{T}')$ is onto is obvious, while condition (ii) clearly implies that it is one-to-one.

As $p_i \circ e = f_i$ is a continuous mapping of (X, \mathcal{T}) into (Y_i, \mathcal{T}_i) , for each i , Proposition 9.4.6 implies that the mapping $e: (X, \mathcal{T}) \rightarrow \prod_{i=1}^{\infty} (Y_i, \mathcal{T}_i)$ is continuous. Hence $e: (X, \mathcal{T}) \rightarrow (e(X), \mathcal{T}')$ is continuous.

To prove that $e: (X, \mathcal{T}) \rightarrow (e(X), \mathcal{T}')$ is an open mapping, it suffices to verify that for each $U \in \mathcal{T}$ and $x \in U$, there exists a set $W \in \mathcal{T}'$ such that $e(x) \in W \subseteq e(U)$. As the family f_i , $i \in \mathbb{N}$, separates points and closed sets, there exists a $j \in \mathbb{N}$ such that $f_j(x) \notin \overline{f_j(X \setminus U)}$. Put

$$W = (Y_1 \times Y_2 \times \cdots \times Y_{j-1} \times [Y_j \setminus \overline{f_j(X \setminus U)}] \times Y_{j+1} \times Y_{j+2} \times \cdots) \cap e(X).$$

Then clearly $e(x) \in W$ and $W \in \mathcal{T}'$. It remains to show that $W \subseteq e(U)$. So let $e(t) \in W$. Then

$$\begin{aligned} f_j(t) &\in Y_j \setminus \overline{f_j(X \setminus U)} \\ \Rightarrow f_j(t) &\notin \overline{f_j(X \setminus U)} \\ \Rightarrow f_j(t) &\notin f_j(X \setminus U) \\ \Rightarrow t &\notin X \setminus U \\ \Rightarrow t &\in U. \end{aligned}$$

So $e(t) \in e(U)$ and hence $W \subseteq e(U)$. Therefore e is a homeomorphism. \square

9.4.8 Definition. A topological space (X, \mathcal{T}) is said to be a **T_1 -space** if every singleton set $\{x\}$, $x \in X$, is a closed set.

9.4.9 Remark. It is easily verified that **every Hausdorff space (i.e. T_2 -space) is a T_1 -space**. The converse, however, is false. (See Exercises 4.1 #13 and Exercises 1.3 #3.) In particular, **every metrizable space is a T_1 -space**.

9.4.10 Corollary. If (X, \mathcal{T}) in Lemma 9.4.7 is a T_1 -space, then condition (ii) is implied by condition (iii) (and so is superfluous).

Proof. Let x_1 and x_2 be any distinct points in X . Putting A equal to the closed set $\{x_2\}$, condition (iii) implies that for some i , $f_i(x_1) \notin \overline{\{f_i(x_2)\}}$. Hence $f_i(x_1) \neq f_i(x_2)$, and condition (ii) is satisfied. \square

9.4.11 Theorem. (Urysohn's Theorem) Every separable metric space (X, d) is homeomorphic to a subspace of the Hilbert cube.

Proof. By Corollary 9.4.10 this result will follow if we can find a countably infinite family of mappings $f_i: (X, d) \rightarrow [0, 1]$, which are (i) continuous, and (ii) separate points and closed sets.

Without loss of generality we can assume that $d(a, b) \leq 1$, for all a and b in X , since every metric is equivalent to such a metric.

As (X, d) is separable, there exists a countable dense subset $Y = \{y_i, i \in \mathbb{N}\}$. For each $i \in \mathbb{N}$, define $f_i: X \rightarrow [0, 1]$ by $f_i(x) = d(x, y_i)$. It is clear that each mapping f_i is continuous.

To see that the mappings $\{f_i : i \in \mathbb{N}\}$ separate points and closed sets, let $x \in X$ and A be any closed set not containing x . Now $X \setminus A$ is an open set about x and so contains an open ball B of radius ε and centre x , for some $\varepsilon > 0$.

Further, as Y is dense in X , there exists a y_n such that $d(x, y_n) < \frac{\varepsilon}{2}$. Thus $d(y_n, a) \geq \frac{\varepsilon}{2}$, for all $a \in A$.

So $[0, \frac{\varepsilon}{2})$ is an open set in $[0, 1]$ which contains $f_n(x)$, but $f_n(a) \notin [0, \frac{\varepsilon}{2})$, for all $a \in A$. This implies $f_n(A) \subseteq [\frac{\varepsilon}{2}, 1]$. As the set $[\frac{\varepsilon}{2}, 1]$ is closed, this implies $\overline{f_n(A)} \subseteq [\frac{\varepsilon}{2}, 1]$.

Hence $f_n(x) \notin \overline{f_n(A)}$ and thus the family $\{f_i : i \in \mathbb{N}\}$ separates points and closed sets. □

9.4.12 Corollary. Every compact metrizable space is homeomorphic to a closed subspace of the Hilbert cube. □

9.4.13 Corollary. If for each $i \in \mathbb{N}$, (X_i, \mathcal{T}_i) is a compact metrizable space, then $\prod_{i=1}^{\infty} (X_i, \mathcal{T}_i)$ is compact and metrizable.

Proof. That $\prod_{i=1}^{\infty}(X_i, \mathcal{T}_i)$ is metrizable was proved in Proposition 9.3.9. That $\prod_{i=1}^{\infty}(X_i, \mathcal{T}_i)$ is compact follows from Corollary 9.4.12 and Exercises 9.3 #9 (ii). \square

Our next task is to verify the converse of Urysohn's Theorem. To do this we introduce a new concept. (See Exercises 2.2 #4.)

9.4.14 Definition. A topological space (X, \mathcal{T}) is said to satisfy the **second axiom of countability** (or to be **second countable**) if there exists a basis \mathcal{B} for \mathcal{T} such that \mathcal{B} consists of only a countable number of sets.

9.4.15 Example. Let $\mathcal{B} = \{(q - \frac{1}{n}, q + \frac{1}{n}) : q \in \mathbb{Q}, n \in \mathbb{N}\}$. Then \mathcal{B} is a basis for the euclidean topology on \mathbb{R} . (Verify this). Therefore \mathbb{R} is second countable. \square

9.4.16 Example. Let (X, \mathcal{T}) be an uncountable set with the discrete topology. Then, as every singleton set must be in any basis for \mathcal{T} , (X, \mathcal{T}) does not have any countable basis. So (X, \mathcal{T}) is not second countable. \square

9.4.17 Proposition. Let (X, d) be a metric space and \mathcal{T} the induced topology. Then (X, \mathcal{T}) is a separable space if and only if it satisfies the second axiom of countability.

Proof. Let (X, \mathcal{T}) be separable. Then it has a countable dense subset $Y = \{y_i : i \in \mathbb{N}\}$. Let \mathcal{B} consist of all the open balls (in the metric d) with centre y_i , for some i , and radius $\frac{1}{n}$, for some positive integer n . Clearly \mathcal{B} is countable and we shall show that it is a basis for \mathcal{T} .

Let $V \in \mathcal{T}$. Then for any $v \in V$, V contains an open ball, B , of radius $\frac{1}{n}$ about v , for some n . As Y is dense in X , there exists a $y_m \in Y$, such that $d(y_m, v) < \frac{1}{2n}$. Let B' be the open ball with centre y_m and radius $\frac{1}{2n}$. Then the triangle inequality implies $B' \subseteq B \subseteq V$. Also $B' \in \mathcal{B}$. Hence \mathcal{B} is a basis for \mathcal{T} . So (X, \mathcal{T}) is second countable.

Conversely let (X, \mathcal{T}) be second countable, having a countable basis $\mathcal{B}_1 = \{B_i : i \in \mathbb{N}\}$. For each $B_i \neq \emptyset$, let b_i be any element of B_i , and put Z equal to the set of all such b_i . Then Z is a countable set. Further, if $V \in \mathcal{T}$, then $V \supseteq B_i$, for some i , and so $b_i \in V$. Thus $V \cap Z \neq \emptyset$. Hence Z is dense in X . Consequently (X, \mathcal{T}) is separable. \square

9.4.18 Remark. The above proof shows that **every second countable space is separable**, even without the assumption of metrizable. However, it is **not** true, in general, that a separable space is second countable. (See [Exercises 9.4 #11.](#))

9.4.19 Theorem. (Urysohn's Theorem and its Converse) Let (X, \mathcal{T}) be a topological space. Then (X, \mathcal{T}) is separable and metrizable if and only if it is homeomorphic to a subspace of the Hilbert cube.

Proof. If (X, \mathcal{T}) is separable and metrizable, then [Urysohn's Theorem 9.4.11](#) says that it is homeomorphic to a subspace of the Hilbert cube.

Conversely, let (X, \mathcal{T}) be homeomorphic to the subspace (Y, \mathcal{T}_1) of the Hilbert cube I^∞ . By [Proposition 9.4.4](#), I^∞ is separable. So, by [Proposition 9.4.17](#), it is second countable. It is readily verified ([Exercises 4.1 #14](#)) that any subspace of a second countable space is second countable, and hence (Y, \mathcal{T}_1) is second countable. It is also easily verified ([Exercises 6.1 #6](#)) that any subspace of a metrizable space is metrizable. As the Hilbert cube is metrizable, by [Corollary 9.3.10](#), its subspace (Y, \mathcal{T}_1) is metrizable. So (Y, \mathcal{T}_1) is metrizable and satisfies the second axiom of countability. Therefore it is separable. Hence (X, \mathcal{T}) is also separable and metrizable. \square

Exercises 9.4

1. Prove that every continuous image of a separable space is separable.

2. If (X_i, \mathcal{T}_i) , $i \in \mathbb{N}$, are separable spaces, prove that $\prod_{i=1}^{\infty} (X_i, \mathcal{T}_i)$ is a separable space.
3. If all the spaces (Y_i, \mathcal{T}_i) in [Lemma 9.4.7](#) are Hausdorff and (X, \mathcal{T}) is compact, show that condition (iii) of the lemma is superfluous.
4. If (X, \mathcal{T}) is a countable discrete space, prove that it is homeomorphic to a subspace of the Hilbert cube.
5. Verify that $C[0, 1]$, with the metric d described in [Example 6.1.5](#), is homeomorphic to a subspace of the Hilbert cube.
6. If (X_i, \mathcal{T}_i) , $i \in \mathbb{N}$, are second countable spaces, prove that $\prod_{i=1}^{\infty} (X_i, \mathcal{T}_i)$ is second countable.

Lindelöf's Theorem

7. **(Lindelöf's Theorem)** Prove that **every open covering of a second countable space has a countable subcovering.**
8. Deduce from [Theorem 9.4.19](#) that **every subspace of a separable metrizable space is separable and metrizable.**
9. (i) Prove that the set of all isolated points of a second countable space is countable.
 (ii) Hence, show that any uncountable subset A of a second countable space contains at least one point which is a limit point of A .
10. (i) Let f be a continuous mapping of a Hausdorff non-separable space (X, \mathcal{T}) onto itself. Prove that there exists a proper non-empty closed subset A of X such that $f(A) = A$.
 [Hint: Let $x_0 \in X$ and define a set $S = \{x_n : n \in \mathbb{Z}\}$ such that $x_{n+1} = f(x_n)$ for every integer n .]
 (ii) Is the above result true if (X, \mathcal{T}) is separable? (Justify your answer.)

11. Let \mathcal{T} be the topology defined on \mathbb{R} in Example 2.3.1. Prove that
- (i) $(\mathbb{R}, \mathcal{T})$ is separable;
 - (ii) $(\mathbb{R}, \mathcal{T})$ is not second countable.

Countable Chain Condition

12. A topological space (X, \mathcal{T}) is said to satisfy the **countable chain condition** if every disjoint family of open sets is countable.
- (i) Prove that every separable space satisfies the countable chain condition.
 - (ii) Let X be an uncountable set and \mathcal{T} the countable-closed topology on X . Show that (X, \mathcal{T}) satisfies the countable chain condition but is not separable.

Scattered, Extremely Disconnected, and Collectionwise Hausdorff Spaces,

13. A topological space (X, \mathcal{T}) is said to be **scattered** if every non-empty subspace of X has an isolated point (see [Exercises 9.1 #2](#)).
- (i) Verify that \mathbb{R} , \mathbb{Q} , and the Cantor Space are not scattered, while every discrete space is scattered.
- (ii) Let $X = \mathbb{R}^2$, d the Euclidean metric on \mathbb{R}^2 and d' the metric on X given by $d'(x, y) = d(x, 0) + d(0, y)$ if $x \neq y$ and $d'(x, y) = 0$ if $x = y$. Let \mathcal{T} be the topology induced on X by the metric d' . The metric d' is called the **Post Office Metric**. A topological space is said to be **extremally disconnected** if the closure of every open set is open. A topological space (Y, \mathcal{T}_1) is said to be **collectionwise Hausdorff** if for every discrete subspace (Z, \mathcal{T}_2) of (Y, \mathcal{T}_1) and each pair of points z_1, z_2 in Z , there are disjoint open sets U_1, U_2 in (Y, \mathcal{T}_1) such that $z_1 \in U_1$ and $z_2 \in U_2$. Prove the following:
- (a) Every point in (X, \mathcal{T}) , except $x = 0$, is an isolated point.
- (b) 0 is not an isolated point of (X, \mathcal{T}) .
- (c) (X, \mathcal{T}) is a scattered space.
- (d) (X, \mathcal{T}) is totally disconnected.
- (e) (X, \mathcal{T}) is not compact.
- (f) (X, \mathcal{T}) is not locally compact (see [Exercise 8.3 #1](#)).
- (g) Every separable metric space has cardinality less than or equal to \mathfrak{c} .
- (h) (X, \mathcal{T}) is an example of a metrizable space of cardinality \mathfrak{c} which is not separable. (Note that the metric space (ℓ_∞, d_∞) of [Exercises 6.1 #7 \(iii\)](#) is also of cardinality \mathfrak{c} and not separable.)
- (i) Every discrete space is extremally disconnected.
- (j) (X, \mathcal{T}) is not extremally disconnected.
- (k) The product of any two scattered spaces is a scattered space.
- (l) Let (S, \mathcal{T}_3) be the subspace $\{0, 1, \frac{1}{2}, \frac{1}{3}, \dots, \frac{1}{n}, \dots\}$ of \mathbb{R} . Then S is not extremally disconnected.
- (m)* Every extremally disconnected metrizable space is discrete.
[Hint: Show that every convergent sequence must have repeated terms.]
- (n) A topological space is Hausdorff if and only if it is a T_1 -space and collectionwise Hausdorff.
- (o)* Every extremally disconnected collectionwise Hausdorff space is discrete.

Weight of a Topological Space

14. Let (X, \mathcal{T}) be a topological space and \mathcal{B} a basis for the topology \mathcal{T} with the cardinality of \mathcal{B} , $\text{card } \mathcal{B}$, equal to the cardinal number m . If m is the smallest such cardinal number of a basis for \mathcal{T} , then m is said to be the **weight** of the topological space (X, \mathcal{T}) and is denoted by $w(X, \mathcal{T})$. Of course, if the weight $m \leq \aleph_0$, then (X, \mathcal{T}) is said to be a second countable space.
- (i) If the topological space (Y, \mathcal{T}_1) is a subspace of (X, \mathcal{T}) , verify that the weight of the space (Y, \mathcal{T}_1) is less than or equal to the weight of the space (X, \mathcal{T}) .
- (ii) Let (X_n, \mathcal{T}_n) , $n \in \mathbb{N}$, be topological spaces and m an infinite cardinal number. If each space (X_n, \mathcal{T}_n) has weight not greater than m , prove that the weight of the product space $\prod_{n \in \mathbb{N}} (X_n, \mathcal{T}_n)$ is not greater than m .
- (iii) Deduce from (ii) that the product space \mathbb{R}^{\aleph_0} is second countable.

Network, Network Weight

15. Let (X, \mathcal{T}) be a topological space and \mathcal{N} a set of (not necessarily open) subsets of X . Then \mathcal{N} is said to be a **network** if for each $x \in X$ and each open neighbourhood O of x , there is an $N \in \mathcal{N}$ such that $x \in N \subseteq O$. Let $\text{card } \mathcal{N} = m$. If m is the smallest such cardinal number of a network for (X, \mathcal{T}) , then m is said to be the **network weight** of the topological space (X, \mathcal{T}) , denoted by $nw(X, \mathcal{T})$.
- (i) Verify that for any topological space (X, \mathcal{T}) , $nw(X, \mathcal{T}) \leq w(X, \mathcal{T})$.
- (ii) If (X, \mathcal{T}) is a discrete space, then $nw(X, \mathcal{T}) = w(X, \mathcal{T}) = \text{card } X$.

Cosmic Spaces

16. A topological space (Y, \mathcal{T}) is said to be a **cosmic space** if there is a separable metrizable space (X, \mathcal{T}_1) and a continuous mapping f of (X, \mathcal{T}_1) onto $Y(Y, \mathcal{T})$.
- (i) Verify that a metrizable space is a cosmic space if and only if it is separable.
 - (ii) Prove that if (X_n, \mathcal{T}_n) , $n \in \mathbb{N}$, are cosmic spaces then $\prod_{n \in \mathbb{N}} (X_n, \mathcal{T}_n)$ is a cosmic space.
 - (iii) Verify that **every continuous image of a cosmic space is a cosmic space**.
 - (iv) Prove that **every subspace of a cosmic space is a cosmic space**.
 - (v) Prove that the cardinality of a cosmic space is less than or equal to \mathfrak{c} , the cardinality of the set \mathbb{R} of real numbers.
 - (vi) Prove that **every cosmic space has a countable network**. (See Exercises 9.4 #15. above.)
 - (vii) Verify that **every cosmic space is a Lindelöf space**. (See Exercises 10.3 #7.)

9.5 Peano's Theorem

9.5.1 Remark. In the proof of Theorem 9.3.8 we showed that the Hilbert cube I^∞ is a continuous image of the Cantor Space (G, \mathcal{T}) . In fact, every compact metric space is a continuous image of the Cantor Space. The next proposition is a step in this direction.

9.5.2 Proposition. Every separable metrizable space (X, \mathcal{T}_1) is a continuous image of a subspace of the Cantor Space (G, \mathcal{T}) . Further, if (X, \mathcal{T}_1) is compact, then the subspace can be chosen to be closed in (G, \mathcal{T}) .

Proof. Let ϕ be the continuous mapping of (G, \mathcal{T}) onto I^∞ shown to exist in the proof of [Theorem 9.3.8](#). By [Urysohn's Theorem 9.4.19](#), (X, \mathcal{T}_1) is homeomorphic to a subspace (Y, \mathcal{T}_2) of I^∞ . Let the homeomorphism of (Y, \mathcal{T}_2) onto (X, \mathcal{T}_1) be Θ . Let $Z = \psi^{-1}(Y)$ and \mathcal{T}_3 be the subspace topology on Z . Then $\Theta \circ \psi$ is a continuous mapping of (Z, \mathcal{T}_3) onto (X, \mathcal{T}_1) . So (X, \mathcal{T}_1) is a continuous image of the subspace (Z, \mathcal{T}_3) of (G, \mathcal{T}) .

Further if (X, \mathcal{T}_1) is compact, then (Y, \mathcal{T}_2) is compact and hence closed in I^∞ . So $Z = \psi^{-1}(Y)$ is a closed subset of (G, \mathcal{T}) , as required. \square

9.5.3 Proposition. Let (Y, \mathcal{T}_1) be a (non-empty) closed subspace of the Cantor Space (G, \mathcal{T}) . Then there exists a continuous mapping of (G, \mathcal{T}) onto (Y, \mathcal{T}_1) .

Proof. Let (G', \mathcal{T}') be the set of all real numbers which can be written in the form $\sum_{i=1}^{\infty} \frac{a_i}{6^i}$, where each $a_i = 0$ or 5 , with the subspace topology induced from \mathbb{R} . The space (G', \mathcal{T}') is called the **middle two-thirds Cantor Space**. Clearly (G', \mathcal{T}') is homeomorphic to the Cantor Space (G, \mathcal{T}) .

We can regard (Y, \mathcal{T}_1) as a closed subspace of (G', \mathcal{T}') and seek a continuous mapping of (G', \mathcal{T}') onto (Y, \mathcal{T}_1) . Before proceeding, observe from the construction of the middle two thirds Cantor space that if $g_1 \in G'$ and $g_2 \in G'$, then $\frac{g_1+g_2}{2} \notin G'$.

The map $\psi : (G', \mathcal{T}')$ \longrightarrow (Y, \mathcal{T}_1) which we seek is defined as follows: for $g \in G'$, $\psi(g)$ is the unique element of Y which is closest to g in the euclidean metric on \mathbb{R} . However we have to prove that such a unique closest element exists.

Fix $g \in G'$. Then the map $d_g : (Y, \mathcal{T}_1) \longrightarrow \mathbb{R}$ given by $d_g(y) = |g - y|$ is continuous. As (Y, \mathcal{T}_1) is compact, [Proposition 7.2.15](#) implies that $d_g(Y)$ has a least element. So there exists an element of (Y, \mathcal{T}_1) which is closest to g . Suppose there are two such elements y_1 and y_2 in Y which are equally close to g . Then $g = \frac{y_1+y_2}{2}$. But $y_1 \in G'$ and $y_2 \in G'$ and so, as observed above, $g = \frac{y_1+y_2}{2} \notin G'$,

which is a contradiction. So there exists a unique element of Y which is closest to g . Call this element $\psi(g)$.

It is clear that the map $\psi: (G', \mathcal{T}') \rightarrow (Y, \mathcal{T}_1)$ is surjective, since for each $y \in Y$, $\psi(y) = y$. To prove continuity of ψ , let $g \in G'$. Let ε be any given positive real number. Then it suffices, by [Corollary 6.2.4](#), to find a $\delta > 0$, such that if $x \in G'$ and $|g - x| < \delta$ then $|\psi(g) - \psi(x)| < \varepsilon$.

Consider firstly the case when $g \in Y$, so $\psi(g) = g$. Put $\delta = \frac{\varepsilon}{2}$. Then for $x \in G'$ with $|g - x| < \delta$ we have

$$\begin{aligned} |\psi(g) - \psi(x)| &= |g - \psi(x)| \\ &\leq |x - \psi(x)| + |g - x| \\ &\leq |x - g| + |g - x|, \text{ by definition of } \psi \text{ since } g \in Y \\ &= 2|x - g| \\ &< 2\delta \\ &= \varepsilon, \text{ as required.} \end{aligned}$$

Now consider the case when $g \notin Y$, so $g \neq \psi(g)$.

Without loss of generality, assume $\psi(g) < g$ and put $a = g - \psi(g)$.

If the set $Y \cap [g, 1] = \emptyset$, then $\psi(x) = \psi(g)$ for all $x \in (g - \frac{a}{2}, g + \frac{a}{2})$.

Thus for $\delta < \frac{a}{2}$, we have $|\psi(x) - \psi(g)| = 0 < \varepsilon$, as required.

If $Y \cap [g, 1] \neq \emptyset$, then as $Y \cap [g, 1]$ is compact it has a least element $y > g$.

Indeed by the definition of ψ , if $b = y - g$, then $b > a$.

Now put $\delta = \frac{b-a}{2}$.

So if $x \in G'$ with $|g - x| < \delta$, then either $\psi(x) = \psi(g)$ or $\psi(x) = y$. Observe that

$$|x - \psi(g)| \leq |x - g| + |g - \psi(g)| < \delta + a = \frac{b-a}{2} + a = \frac{b}{2} + \frac{a}{2}$$

while

$$|x - y| \geq |g - y| - |g - x| \geq b - \frac{b-a}{2} = \frac{b}{2} + \frac{a}{2}.$$

So $\psi(x) = \psi(g)$.

Thus $|\psi(x) - \psi(g)| = 0 < \varepsilon$, as required. Hence ψ is continuous. \square

Thus we obtain from [Propositions 9.5.2](#) and [9.5.3](#) the following theorem of Alexandroff and Urysohn:

9.5.4 Theorem. Every compact metrizable space is a continuous image of the Cantor Space. □

9.5.5 Remark. The converse of [Theorem 9.5.4](#) is false. It is not true that every continuous image of a Cantor Space is a compact metrizable space. (Find an example.) However, an analogous statement is true if we look only at Hausdorff spaces. Indeed we have the following proposition.

9.5.6 Proposition. Let f be a continuous mapping of a compact metric space (X, d) onto a Hausdorff space (Y, \mathcal{T}_1) . Then (Y, \mathcal{T}_1) is compact and metrizable.

Proof. Since every continuous image of a compact space is compact, the space (Y, \mathcal{T}_1) is certainly compact. As the map f is surjective, we can define a metric d_1 on Y as follows: for each $y_1, y_2 \in Y$, $d_1(y_1, y_2)$ equals

$$\inf_{n \in \mathbb{N}} \{d(a_1, b_1) + \cdots + d(a_n, b_n) : f(a_1) = y_1, f(b_n) = y_2, b_i = a_{i+1}, i = 1, \dots, n-1\}.$$

We need to show that d_1 is indeed a metric; this is left as an exercise. (See [Exercises 9.5 #3.](#))

Let \mathcal{T}_2 be the topology induced on Y by d_1 . We have to show that $\mathcal{T}_1 = \mathcal{T}_2$.

Firstly, by the definition of d_1 , $f: (X, \mathcal{T}) \rightarrow (Y, \mathcal{T}_2)$ is certainly continuous and so (X, \mathcal{T}_2) is compact.

Observe that for a subset C of Y ,

$$\begin{aligned} & C \text{ is a closed subset of } (Y, \mathcal{T}_1) \\ \Rightarrow & f^{-1}(C) \text{ is a closed subset of } (X, \mathcal{T}) \\ \Rightarrow & f^{-1}(C) \text{ is a compact subset of } (X, \mathcal{T}) \\ \Rightarrow & f(f^{-1}(C)) \text{ is a compact subset of } (Y, \mathcal{T}_2) \\ \Rightarrow & C \text{ is a compact subset of } (Y, \mathcal{T}_2) \\ \Rightarrow & C \text{ is closed in } (Y, \mathcal{T}_2). \end{aligned}$$

So $\mathcal{T}_1 \subseteq \mathcal{T}_2$. Similarly we can prove $\mathcal{T}_2 \subseteq \mathcal{T}_1$, and thus $\mathcal{T}_1 = \mathcal{T}_2$. □

9.5.7 Corollary. Let (X, \mathcal{T}) be a Hausdorff space. Then it is a continuous image of the Cantor Space if and only if it is compact and metrizable. \square

Finally in this chapter we turn to space-filling curves.

9.5.8 Remark. Everyone thinks he or she knows what a “curve” is. Formally we can define a curve in \mathbb{R}^2 to be the set $f[0, 1]$, where f is a continuous map $f : [0, 1] \rightarrow \mathbb{R}^2$. It seems intuitively clear that a curve has no breadth and hence zero area. This is false! In fact there exist space-filling curves; that is, $f(I)$ has non-zero area. Indeed the next theorem shows that there exists a continuous mapping of $[0, 1]$ onto the product space $[0, 1] \times [0, 1]$.

9.5.9 Theorem. (Peano) For each positive integer n , there exists a continuous mapping ψ_n of $[0, 1]$ onto the n -cube I^n .

Proof. By [Theorem 9.5.4](#), there exists a continuous mapping ϕ_n of the Cantor Space (G, \mathcal{T}) onto the n -cube I^n . As (G, \mathcal{T}) is obtained from $[0, 1]$ by successively dropping out middle thirds, we extend ϕ_n to a continuous mapping $\psi_n : [0, 1] \rightarrow I^n$ by defining ψ_n to be linear on each omitted interval; that is, if (a, b) is one of the open intervals comprising $[0, 1] \setminus G$, then ψ_n is defined on (a, b) by

$$\psi_n(\alpha a + (1 - \alpha)b) = \alpha \phi_n(a) + (1 - \alpha) \phi_n(b), \quad 0 \leq \alpha \leq 1.$$

It is easily verified that ψ_n is continuous. \square

We conclude this chapter by stating (but not proving) the Hahn-Mazurkiewicz Theorem which characterizes those Hausdorff spaces which are continuous images of $[0, 1]$. [For a proof of the theorem see Wilder [\[424\]](#) and p. 221 of Kuratowski [\[249\]](#).] But first we need a definition.

9.5.10 Definition. A topological space (X, \mathcal{T}) is said to be **locally connected** if it has a basis of connected (open) sets.

9.5.11 Remark. Every discrete space is locally connected as are \mathbb{R}^n and \mathbb{S}^n , for all $n \geq 1$. However, not every connected space is locally connected. (See [Exercises 8.4 #6.](#))

Our final theorem in this section is beautiful. It was proved by Hans Hahn (1879–1934) and Stefan Mazurkiewicz (1888–1945). Its proof can be found in Hocking and Young [[189](#)].

9.5.12 Theorem. (Hahn-Mazurkiewicz Theorem) Let (X, \mathcal{T}) be a Hausdorff space. Then (X, \mathcal{T}) is a continuous image of $[0, 1]$ if and only if it is compact, connected, metrizable and locally connected.



Hahn



Mazurkiewicz

Exercises 9.5

1. Let $S \subset \mathbb{R}^2$ be the set of points inside and on the triangle ABC , which has a right angle at A and satisfies $AC > AB$. This exercise outlines the construction of a continuous surjection $f : [0, 1] \rightarrow S$. (This provides an easy example of a **space-filling curve**; the curve $f([0, 1])$ fills S .)

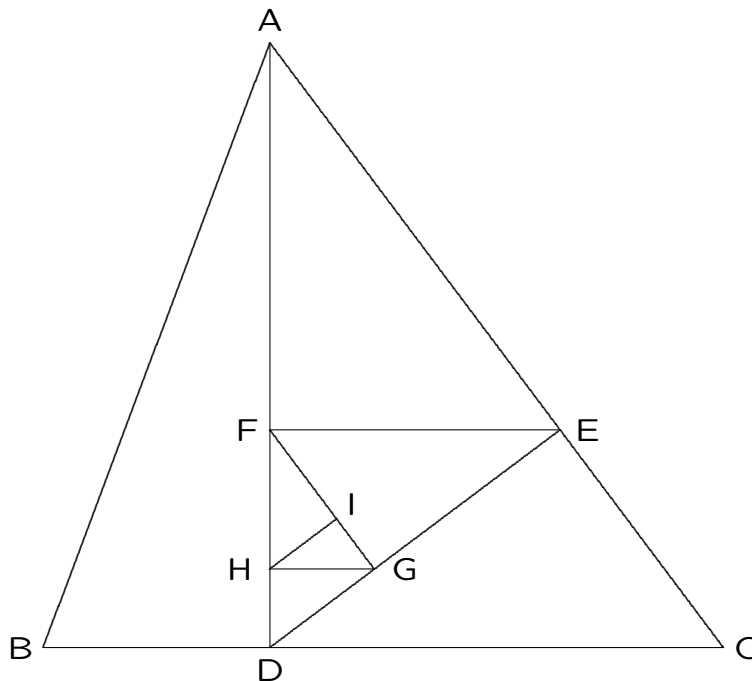

Let D on BC be such that AD is perpendicular to BC . Let $a = \cdot a_1 a_2 a_3 \dots$ be a binary decimal, so that each a_n is 0 or 1. Then we construct a sequence of points of S as follows : E is the foot of the perpendicular from D onto the hypotenuse of the larger or smaller of the triangles ADB , ADC according as $a_1 = 1$ or 0, respectively. This construction is now repeated using E instead of D and the appropriate triangle of ADB , ADC instead of ABC . For example, the figure above illustrates the points E to I for the binary decimal $\cdot 11001 \dots$. Give a rigorous inductive definition of the sequence of points and prove

- (i) the sequence of points tends to a limit $L(a)$ in S ;
- (ii) if $\lambda \in [0, 1]$ is represented by distinct binary decimals a, a' then $L(a) = L(a')$;
hence, the point $L(\lambda)$ in S is uniquely defined;
- (iii) if $f : [0, 1] \rightarrow S$ is given by $f(\lambda) = L(\lambda)$, then f is surjective;
- (iv) f is continuous.

2. Let (G, \mathcal{T}) be the Cantor Space and consider the mappings

$$\phi_i: (G, \mathcal{T}) \rightarrow [0, 1], \quad i = 1, 2,$$

where

$$\phi_1 \left[\sum_{i=1}^{\infty} \frac{a_i}{3^i} \right] = \frac{a_1}{2^2} + \frac{a_3}{2^3} + \cdots + \frac{a_{2n-1}}{2^{n+1}} + \cdots$$

and

$$\phi_2 \left[\sum_{i=1}^{\infty} \frac{a_i}{3^i} \right] = \frac{a_2}{2^2} + \frac{a_4}{2^3} + \cdots + \frac{a_{2n}}{2^{n+1}} + \cdots$$

- (i) Prove that ϕ_1 and ϕ_2 are continuous.
 (ii) Prove that the map $a \mapsto \langle \phi_1(a), \phi_2(a) \rangle$ is a continuous map of (G, \mathcal{T}) onto $[0, 1] \times [0, 1]$.
 (iii) If a and $b \in (G, \mathcal{T})$ and $(a, b) \cap G = \emptyset$, define, for $j = 1, 2$,

$$\phi_j(x) = \frac{b-x}{b-a} \phi_j(a) + x - ab - a \phi_j(b), \quad a \leq x \leq b.$$

Show that

$$x \mapsto \langle \phi_1(x), \phi_2(x) \rangle$$

is a continuous mapping of $[0, 1]$ onto $[0, 1] \times [0, 1]$ and that each point of $[0, 1] \times [0, 1]$ is the image of at most three points of $[0, 1]$.

3. Prove that d_1 in the proof of [Proposition 9.5.6](#) is indeed a metric.

9.6 Postscript

In this chapter we have extended the notion of a product of a finite number of topological spaces to that of the product of a countable number of topological spaces. While this step is a natural one, it has led us to a rich collection of results, some of which are very surprising.

We proved that a countable product of topological spaces with property \mathcal{P} has property \mathcal{P} , where \mathcal{P} is any of the following: (i) T_0 -space (ii) T_1 -space (iii) Hausdorff (iv) metrizable (v) connected (vi) totally disconnected (vii) second countable. It is also true when \mathcal{P} is compact, this result being the Tychonoff

Theorem for countable products. The proof of the countable Tychonoff Theorem for metrizable spaces presented here is quite different from the standard one which appears in the next section. Our proof relies on the Cantor Space.

The Cantor Space was defined to be a certain subspace of $[0, 1]$. Later it was shown that it is homeomorphic to a countably infinite product of 2-point discrete spaces. The Cantor Space appears to be the kind of pathological example pure mathematicians are fond of producing in order to show that some general statement is false. But it turns out to be much more than this.

The [Alexandroff-Urysohn Theorem 9.5.4](#) says that every compact metrizable space is an image of the Cantor Space. In particular $[0, 1]$ and the Hilbert cube (a countable infinite product of copies of $[0, 1]$) is a continuous image of the Cantor Space. This leads us to the existence of space-filling curves – in particular, we show that there exists a continuous map of $[0, 1]$ onto the cube $[0, 1]^n$, for each positive integer n . We stated, but did not prove, the [Hahn-Mazurkiewicz Theorem 9.5.12](#): The Hausdorff space (X, \mathcal{T}) is an image of $[0, 1]$ if and only if it is compact connected locally connected and metrizable.

Next we mention [Urysohn's Theorem 9.4.19](#), which says that a space is separable and metrizable if and only if it is homeomorphic to a subspace of the Hilbert cube. This shows that $[0, 1]$ is not just a “nice” topological space, but a “generator” of the important class of separable metrizable spaces via the formation of subspaces and countable products.

Finally we mention a beautiful and deep theorem related to countably infinite products which we have not proved in this chapter. For proofs of this theorem and discussion, see Anderson and Bing [12], Toruńczyk [396], and Bessaga and Pelczyński [41]. We include a few related and surprising results from Bessaga and Pelczyński [41]; for example, **the open unit ball, the closed unit ball, the unit sphere, any non-empty open convex subset, and any closed convex set with non-empty interior in a separable infinite-dimensional Banach space B are homeomorphic to each other and to the whole space B .**

Note that, within the context of topological vector spaces a **Frechet space** is a complete metrizable locally convex topological vector space.

9.6.1 Theorem. (Anderson-Bessaga-Kadec-Pelczyński-Toruńczyk)

- (i) Every separable infinite-dimensional Fréchet space is homeomorphic to the countably infinite product \mathbb{R}^{\aleph_0} ;
- (2) Every infinite-dimensional Fréchet space is homeomorphic to a Hilbert space.

9.6.2 Corollary. Every separable infinite-dimensional Banach space is homeomorphic to the countably infinite product \mathbb{R}^{\aleph_0} .

9.6.3 Corollary. Every separable infinite-dimensional Banach space is homeomorphic to the separable Hilbert space ℓ_2 .

9.6.4 Corollary. If B_1 and B_2 are any separable infinite-dimensional Banach spaces, then B_1 is homeomorphic to B_2 .

9.6.5 Theorem. (Bessaga and Pelczynski [41, Chapter VI, Theorem 6.2]) Let B be an infinite-dimensional Banach space, $S = \{x : x \in B, \|x\| = r\}$ a sphere in B of radius $r > 0$, and $C = \{x : x \in B, \|x\| \leq r\}$ a closed ball in B . Then B , S and C are homeomorphic.

9.6.6 Remark. Let N be an infinite-dimensional normed vector space and $O = \{x : \|x\| < 1\}$ an open ball in N of radius 1. Observe that $x \mapsto \frac{x}{1+\|x\|}$ is a continuous map of N onto O with continuous inverse $x \mapsto \frac{x}{1-\|x\|}$. So the open unit ball O is homeomorphic to N . Indeed every open ball in N is homeomorphic to N .

9.6.7 Corollary. (Bessaga and Pelczynski [41, Chapter VI, Theorem 6.2])

Let B be an infinite-dimensional Banach space. If $S = \{x : x \in B, \|x\| = r\}$ a sphere in B of radius $r > 0$, $C = \{x : x \in B, \|x\| \leq r\}$ a closed ball in B , and $O = \{x : x \in B, \|x\| < r\}$ an open ball in B , then B , S , C and O are homeomorphic.

Indeed, if E is a closed convex subspace of an infinite-dimensional Fréchet space F such that E has non-empty interior, then E is homeomorphic to F . \square

9.6.8 Corollary. If F is a separable infinite-dimensional Fréchet space, B is a separable infinite-dimensional Banach space, S is a sphere in B , C is a closed ball in B , O is an open ball in B , W is an open convex subspace of F , E is a G_δ subspace of F with non-empty interior, then the following topological spaces are homeomorphic.

- (a) \mathbb{R}^{\aleph_0} ;
- (b) $(\mathbb{R}^{\aleph_0})^m$, where m is any positive integer or \aleph_0 ;
- (c) ℓ_2 ;
- (d) $(\ell_2)^m$, where m is any positive integer or \aleph_0 ;
- (e) F ;
- (f) F^m , where m is any positive integer or \aleph_0 ;
- (g) B ;
- (h) B^m , where m is any positive integer or \aleph_0 ;
- (i) $\prod_{i=1}^{\infty} G_i$, where each G_i is a separable infinite-dimensional Fréchet or Banach or Hilbert space;
- (j) S^m , where m is any positive integer or \aleph_0 ;
- (k) C^m , where m is any positive integer or \aleph_0 ;
- (l) O^m , where m is any positive integer or \aleph_0 ;
- (m) W^m , where m is any positive integer or \aleph_0 ;
- (n) E^m , where m is any positive integer or \aleph_0 . \square

9.6.9 Remark. Teachers of topology and authors of books on topology should give some thought to [Corollary 9.6.8](#). Often when teaching topology some teachers give many examples of topological spaces drawn from the set of infinite-dimensional separable Banach spaces. But we now see that these spaces are all homeomorphic, so as far as topology is concerned they represent the same example over and over again. □

9.7 Credits for Images

1. Hans Hahn. Copyright information:

<http://www-history.mcs.st-andrews.ac.uk/Miscellaneous/Copyright.html>.

2. Stefan Mazurkiewicz. This photograph is in the public domain because according to the Art. 3 of copyright law of March 29, 1926 of the Republic of Poland and Art. 2 of copyright law of July 10, 1952 of the People's Republic of Poland, all photographs by Polish photographers (or published for the first time in Poland or simultaneously in Poland and abroad) published without a clear copyright notice before the law was changed on May 23, 1994 are assumed public domain in Poland.

Chapter 10

Tychonoff's Theorem

Introduction

In [Chapter 9](#) we defined the product of a countably infinite family of topological spaces. We now proceed to define the product of any family of topological spaces by replacing the set $\{1, 2, \dots, n, \dots\}$ by an arbitrary index set I . The central result will be the general Tychonoff Theorem.

The reader should be aware that this chapter is more sophisticated and challenging than previous chapters. However, the reward is that you will experience, and hopefully enjoy, some beautiful mathematics.

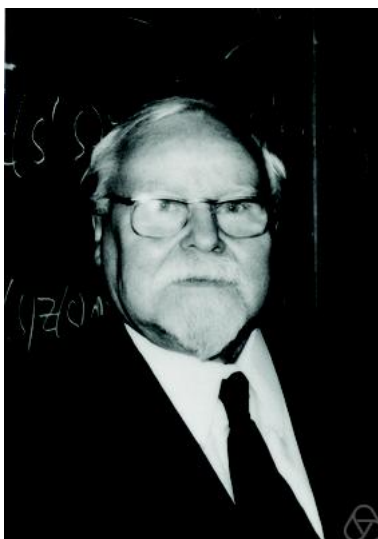

[Andrey Nikolayevich Tychonoff \(or Tikhonov\)](#)

Russian mathematician (1906–1993)

10.1 The Product Topology For All Products

10.1.1 Definitions. Let I be a set, and for each $i \in I$, let (X_i, \mathcal{T}_i) be a topological space. We write the indexed family of topological spaces as $\{(X_i, \mathcal{T}_i) : i \in I\}$. Then the **product** (or **cartesian product**) of the family of sets $\{X_i : i \in I\}$ is denoted by $\prod_{i \in I} X_i$, and consists of the set of all functions $f: I \rightarrow \bigcup_{i \in I} X_i$ such that $f_i = x_i \in X_i$. We denote the element f of the product by $\prod_{i \in I} x_i$, and refer to $f(i) = x_i$ as the i^{th} coordinate.

If $I = \{1, 2\}$ then $\prod_{i \in \{1, 2\}} X_i$ is just the set of all functions $f: \{1, 2\} \rightarrow X_1 \cup X_2$ such that $f(1) \in X_1$ and $f(2) \in X_2$. A moment's thought shows that $\prod_{i \in \{1, 2\}} X_i$ is a set "isomorphic to" $X_1 \times X_2$. Similarly if $I = \{1, 2, \dots, n, \dots\}$, then $\prod_{i \in I} X_i$ is "isomorphic to" our previously defined $\prod_{i=1}^{\infty} X_i$.

The **product space**, denoted by $\prod_{i \in I} (X_i, \mathcal{T}_i)$, consists of the product set $\prod_{i \in I} X_i$ with the topology \mathcal{T} having as its basis the family

$$\mathcal{B} = \left\{ \prod_{i \in I} O_i : O_i \in \mathcal{T}_i \text{ and } O_i = X_i, \text{ for all but a finite number of } i \right\}.$$

The topology \mathcal{T} is called the **product topology** (or the **Tychonoff topology**).

10.1.2 Remark. Although we have defined $\prod_{i \in I} (X_i, \mathcal{T}_i)$ rather differently to the way we did when I was countably infinite or finite you should be able to convince yourself that when I is countably infinite or finite the new definition is equivalent to our previous ones. Once this is realized many results on countable products can be proved for uncountable products in an analogous fashion. We state them below. It is left as an exercise for the reader to prove these results for uncountable products.

10.1.3 Proposition. Let I be a set and for $i \in I$, let C_i be a closed subset of a topological space (X_i, \mathcal{T}_i) . Then $\prod_{i \in I} C_i$ is a closed subset of $\prod_{i \in I} (X_i, \mathcal{T}_i)$. \square

10.1.4 Proposition. Let I be a set and let $\{(X_i, \mathcal{T}_i) : i \in I\}$ be a family of topological spaces having product space $(\prod_{i \in I} X_i, \mathcal{T})$. If for each $i \in I$, B_i is a basis for \mathcal{T}_i , then

$$\mathcal{B}' = \left\{ \prod_{i \in I} O_i : O_i \in B_i \text{ and } O_i = X_i \text{ for all but a finite number of } i \right\}$$

is a basis for \mathcal{T} . \square

10.1.5 Proposition. Let I be a set and let $\{(X_i, \mathcal{T}_i) : i \in I\}$ be a family of topological spaces having product space $(\prod_{i \in I} X_i, \mathcal{T})$. For each $j \in I$, let $p_j : \prod_{i \in I} X_i \rightarrow X_j$ be the projection mapping; that is, $p_j(\prod_{i \in I} x_i) = x_j$, for each $\prod_{i \in I} x_i \in \prod_{i \in I} X_i$. Then

- (i) each p_j is a continuous surjective open mapping, and
- (ii) \mathcal{T} is the coarsest topology on the set $\prod_{i \in I} X_i$ such that each p_j is continuous. \square

10.1.6 Proposition. Let I be a set and let $\{(X_i, \mathcal{T}_i) : i \in I\}$ be a family of topological spaces with product space $\prod_{i \in I} (X_i, \mathcal{T}_i)$. Then each (X_i, \mathcal{T}_i) is homeomorphic to a subspace of $\prod_{i \in I} (X_i, \mathcal{T}_i)$. \square

10.1.7 Proposition. Let I be a set and let $\{(X_i, \mathcal{T}_i) : i \in I\}$ and $\{(Y_i, \mathcal{T}'_i) : i \in I\}$ be families of topological spaces. If $h_i: (X_i, \mathcal{T}_i) \rightarrow (Y_i, \mathcal{T}'_i)$ is a continuous mapping, for each $i \in I$, then $h: \prod_{i \in I} (X_i, \mathcal{T}_i) \rightarrow \prod_{i \in I} (Y_i, \mathcal{T}'_i)$ is continuous, where $h(\prod_{i \in I} x_i) = \prod_{i \in I} h_i(x_i)$. \square

10.1.8 Proposition. Let I be a set and let $\{(X_i, \mathcal{T}_i) : i \in I\}$ be a family of topological spaces and f a mapping of a topological space (Y, \mathcal{T}) into $\prod_{i \in I} (X_i, \mathcal{T}_i)$. Then f is continuous if and only if each mapping $p_i \circ f : (Y, \mathcal{T}) \rightarrow (X_i, \mathcal{T}_i)$ is continuous, where $p_i, i \in I$, denotes the projection mapping of $\prod_{i \in I} (X_i, \mathcal{T}_i)$ onto (X_i, \mathcal{T}_i) . \square

10.1.9 Lemma. (The Embedding Lemma) Let I be an index set and $\{(Y_i, \mathcal{T}_i) : i \in I\}$ a family of topological spaces and for each $i \in I$, let f_i be a mapping of a topological space (X, \mathcal{T}) into (Y_i, \mathcal{T}_i) . Further let $e : (X, \mathcal{T}) \rightarrow \prod_{i \in I} (Y_i, \mathcal{T}_i)$ be the **evaluation map**; that is, $e(x) = \prod_{i \in I} f_i(x)$, for all $x \in X$. Then e is a homeomorphism of (X, \mathcal{T}) onto the space $(e(X), \mathcal{T}')$, where \mathcal{T}' is the subspace topology on $e(X)$ if

- (i) each f_i is continuous.
- (ii) the family $\{f_i : i \in I\}$ **separates points** of X ; that is, if x_1 and x_2 are in X with $x_1 \neq x_2$, then for some $i \in I$, $f_i(x_1) \neq f_i(x_2)$, and
- (iii) the family $\{f_i : i \in I\}$ **separates points and closed sets**; that is, for $x \in X$ and A any closed subset of (X, \mathcal{T}) not containing x , $f_i(x) \notin \overline{f_i(A)}$, for some $i \in I$. \square

10.1.10 Corollary. If (X, \mathcal{T}) in [Lemma 10.1.9](#) is a T_1 -space, then condition (ii) is superfluous. \square

10.1.11 Definitions. Let (X, \mathcal{T}) and (Y, \mathcal{T}') be topological spaces. Then we say that (X, \mathcal{T}) can be **embedded** in (Y, \mathcal{T}') if there exists a continuous mapping $f: (X, \mathcal{T}) \rightarrow (Y, \mathcal{T}')$, such that $f: (X, \mathcal{T}) \rightarrow (f(X), \mathcal{T}'')$ is a homeomorphism, where \mathcal{T}'' is the subspace topology on $f(X)$ from (Y, \mathcal{T}') . The mapping $f: (X, \mathcal{T}) \rightarrow (Y, \mathcal{T}')$ is said to be an **embedding**.

Exercises 10.1

1. For each $i \in I$, some index set, let (A_i, \mathcal{T}'_i) be a subspace of (X_i, \mathcal{T}_i) .
 - (i) Prove that $\prod_{i \in I} (A_i, \mathcal{T}'_i)$ is a subspace of $\prod_{i \in I} (X_i, \mathcal{T}_i)$.
 - (ii) Prove that $\prod_{i \in I} \overline{A_i} = \overline{\prod_{i \in I} A_i}$.
 - (iii) Prove that $\text{Int}(\prod_{i \in I} A_i) \subseteq \prod_{i \in I} (\text{Int}(A_i))$.
 - (iv) Give an example where equality does not hold in (iii).
2. Let J be any index set, and for each $j \in J$, (G_j, \mathcal{T}_j) a topological space homeomorphic to the Cantor Space, and I_j a topological space homeomorphic to $[0, 1]$. Prove that $\prod_{j \in J} I_j$ is a continuous image of $\prod_{j \in J} (G_j, \mathcal{T}_j)$.
3. Let $\{(X_j, \mathcal{T}_j) : j \in J\}$ be any infinite family of separable metrizable spaces. Prove that $\prod_{j \in J} (X_j, \mathcal{T}_j)$ is homeomorphic to a subspace of $\prod_{j \in J} I_j^\infty$, where each I_j^∞ is homeomorphic to the Hilbert cube.

4. (i) Let J be any infinite index set and $\{(X_{i,j}, \mathcal{T}_{i,j}) : i \in \mathbb{N} \text{ and } j \in J\}$ a family of homeomorphic topological spaces. Prove that

$$\prod_{j \in J} \left(\prod_{i \in \mathbb{N}} (X_{i,j}, \mathcal{T}_{i,j}) \right) \cong \prod_{j \in J} (X_{1,j}, \mathcal{T}_{1,j}).$$

- (ii) For each $j \in J$, any infinite index set, let (A_j, \mathcal{T}'_j) be homeomorphic to the discrete space $\{0, 2\}$ and (G_j, \mathcal{T}_j) homeomorphic to the Cantor Space. Deduce from (i) that

$$\prod_{j \in J} (A_j, \mathcal{T}'_j) \cong \prod_{j \in J} (G_j, \mathcal{T}_j).$$

- (iii) For each $j \in J$, any infinite index set, let I_j be homeomorphic to $[0, 1]$, and I_j^∞ homeomorphic to the Hilbert cube I^∞ . Deduce from (i) that

$$\prod_{j \in J} I_j \cong \prod_{j \in J} I_j^\infty.$$

- (iv) Let J, I_j, I_j^∞ , and (A_j, \mathcal{T}'_j) be as in (ii) and (iii). Prove that $\prod_{j \in J} I_j$ and $\prod_{j \in J} I_j^\infty$ are continuous images of $\prod_{j \in J} (A_j, \mathcal{T}'_j)$.
- (v) Let J and I_j be as in (iii). If, for each $j \in J$, (X_j, \mathcal{T}_j) is a separable metrizable space, deduce from [#3 above](#) and (iii) above that $\prod_{j \in J} (X_j, \mathcal{T}_j)$ is homeomorphic to a subspace of $\prod_{j \in J} I_j$.

5. If I is an index set and each (V_i, \mathcal{T}_i) , $i \in I$, is a topological vector space, then $(\prod_{i \in I} V_i, \mathcal{T})$, with the obvious vector space structure and the product topology \mathcal{T} , is a topological vector space. Deduce that if each (V_i, \mathcal{T}_i) is a locally convex space (or more particularly a normed vector space or a Banach space) then $(\prod_{i \in I} V_i, \mathcal{T})$ is a locally convex space.

6.** Let (E, \mathcal{T}) be a Hausdorff locally convex space. Then there exists an index set I , a set $\{B_i : i \in I\}$ of Banach spaces, and a linear map $\Phi : E \rightarrow \prod_{i \in I} B_i$ (with the product topology) which is an embedding. (In other words, **every Hausdorff locally convex space can be embedded as a topological vector subspace of a product of Banach spaces.**)

[Hint. Let $\{p_i : i \in I\}$ be the set of all continuous seminorms on (E, \mathcal{T}) . Verify that for each $i \in I$, $A_i = \{x : x \in E, p_i(x) = 0\}$ is a vector subspace of E . Let N_i be the quotient vector space E/A_i . Define a seminorm q_i on $N_i = E/A_i$ in a natural way and verify that it is in fact a norm. Thus N_i is a normed vector space. Using [Exercises 6.3 #12](#), let B_i be the Banach space which is the completion of the normed vector space N_i . Verify that the natural linear maps $\phi : E \rightarrow B_i$ are continuous. Prove that these linear maps $\phi_i, i \in I$, define an embedding linear map $\Phi : E \rightarrow \prod_{i \in I} B_i$.]

10.2 Zorn's Lemma

Our next task is to prove the general Tychonoff Theorem which says that any product of compact spaces is compact. However, to do this we need to use Zorn's Lemma which requires a little preparation.

10.2.1 Definitions. (Davey and Priestley [97]) A **partial order** on a set X is a binary relation, denoted by \leq , which has the properties:

- (i) $x \leq x$, for all $x \in X$ (**reflexive**)
- (ii) if $x \leq y$ and $y \leq x$, then $x = y$, for $x, y \in X$ (**antisymmetric**), and
- (iii) if $x \leq y$ and $y \leq z$, then $x \leq z$, for $x, y, z \in X$ (**transitive**)

The set X equipped with the partial order \leq is called a **partially ordered set** or a **poset** and is denoted by (X, \leq) . If $x \leq y$ and $x \neq y$, then we write $x < y$.

10.2.2 Examples. The prototype of a partially ordered set is the set \mathbb{N} of all natural numbers equipped with the usual ordering of natural numbers.

Similarly the sets \mathbb{Z} , \mathbb{Q} , and \mathbb{R} with their usual orderings form partially ordered sets. □

10.2.3 Example. Let \mathbb{N} be the set of natural numbers and let \leq be defined as follows:

$$n \leq m \quad \text{if} \quad n \text{ divides } m$$

So $3 \leq 6$ but $3 \not\leq 5$. (It is left as an exercise to verify that with this ordering \mathbb{N} is a partially ordered set.) \square

10.2.4 Example. Let X be the class of all subsets of a set U . We can define a partial ordering on X by putting

$$A \leq B \quad \text{if} \quad A \text{ is a subset of } B$$

where A and B are in X .

It is easily verified that this is a partial order. \square

10.2.5 Example. Let (X, \leq) be a partially ordered set. We can define a new partial order \leq^* on X by defining

$$x \leq^* y \quad \text{if} \quad y \leq x.$$

\square

10.2.6 Example. There is a convenient way of picturing partially ordered sets; this is by an **order diagram**.

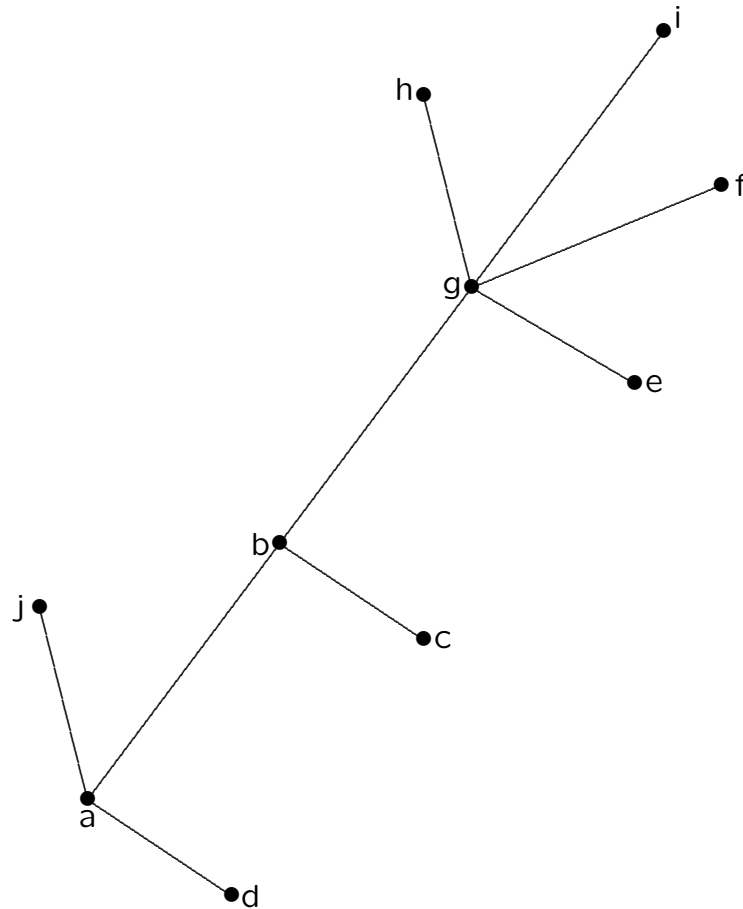

An element x is less than an element y if and only if one can go from x to y by moving upwards on line segments. So in our order diagram

$$\begin{aligned}
 &a < b, a < g, a < h, a < i, a < j, a < f, b < g, b < h, \\
 &b < i, b < f, c < b, c < f, c < g, c < h, c < i, d < a, d < b, \\
 &d < g, d < h, d < f, d < i, d < j, e < f, e < g, e < h, e < i, \\
 &f < g, f < h, g < h, g < i.
 \end{aligned}$$

However $d \not< c$ and $c \not< d$, $e \not< f$ and $f \not< e$, etc.

□

10.2.7 Definition. Two elements x and y of a partially ordered set (X, \leq) are said to be **comparable** if either $x \leq y$ or $y \leq x$.

10.2.8 Remark. We saw in the order diagram above that the elements d and c are not comparable. Also 1 and e are not comparable.

In \mathbb{N} , \mathbb{Q} , \mathbb{R} , and \mathbb{Z} with the usual orderings, every two elements are comparable.

In [Example 10.2.4](#), 3 and 5 are not comparable. \square

10.2.9 Definitions. A partially ordered set (X, \leq) is said to be **linearly ordered** (or **totally ordered**) if every two elements are comparable. The order \leq is then said to be a **linear order** (or a **total order**.) The linear ordering is said to be a **strict linear ordering** (or a **strict total ordering**) if

$$a \leq b \text{ and } b \leq a \implies a = b, \text{ for } a, b \in X.$$

10.2.10 Examples. The usual orders on \mathbb{R} , \mathbb{Q} , \mathbb{N} , and \mathbb{Z} are linear orders.

The partial order of [Example 10.2.4](#) is not a linear order (if U has at least two points). \square

10.2.11 Definition. Let (X, \leq) be a partially ordered set. Then an element $s \in X$ is said to be the **greatest element** of X if $x \leq s$, for all $x \in X$.

10.2.12 Definition. Let (X, \leq) be a partially ordered set and Y a subset of X . An element $t \in X$ is said to be an **upper bound** for Y if $y \leq t$, for all $y \in Y$.

It is important to note that an upper bound for Y need not be in Y .

10.2.13 Definition. Let (X, \leq) be a partially ordered set. Then an element $w \in X$ is said to be **maximal** if $w \leq x$, with $x \in X$, implies $w = x$.

10.2.14 Remark. It is important to distinguish between maximal elements and greatest elements. Consider the order diagram in [Example 10.2.6](#). There is no greatest element! However, j, h, i and f are all maximal elements. \square

10.2.15 Remark. We can now state Zorn's Lemma. Despite the name "Lemma", it is, in fact, an axiom and cannot be proved. It is equivalent to various other axioms of Set Theory such as the Axiom of Choice and the Well-Ordering Theorem. [A partially ordered set (S, \leq) is said to be **well-ordered** if every non-empty subset of S has a least element. [The Well-Ordering Theorem states that there exists a well-ordering on every set.](#) See, for example, Halmos [168] or Wilder [424].] For a discussion of Zorn's Lemma, the Axiom of Choice and Tychonoff's Theorem, see [Remark A6.1.24](#). Also see Rubin and Rubin [348]. We shall take Zorn's Lemma as one of the axioms of our set theory and so use it whenever we wish.

10.2.16 Axiom. (Zorn's Lemma) Let (X, \leq) be a non-empty partially ordered set in which every subset which is linearly ordered has an upper bound. Then (X, \leq) has a maximal element.

10.2.17 Example. Let us apply [Zorn's Lemma](#) to the lattice diagram of [Example 10.2.6](#). There are many linearly ordered subsets:

$$\begin{aligned} &\{i, g, b, a\}, \{g, b, a\}, \{b, a\}, \{g, b\}, \{i, g\}, \{a\}, \{b\}, \\ &\{g\}, \{i\}, \{i, b, a\}, \{i, g, a\}, \{i, a\}, \{g, a\}, \{h, g, e\}, \\ &\{h, e\}, \{g, e\}, \text{ etc.} \end{aligned}$$

Each of these has an upper bound – $i, i, i, i, i, i, i, i, i, i, i, i, h, h, h$, etc. [Zorn's Lemma](#) then says that there is a maximal element. In fact there are 4 maximal elements, j, h, f and i . \square

Exercises 10.2

1. Let $X = \{a, b, c, d, e, f, u, v\}$. Draw the order diagram of the partially ordered set (X, \leq) where

$$v < a, v > b, v < c, v < d, v < e, v < f, v < u,$$

$$a < c, a < d, a < e, a < f, a < u,$$

$$b < c, b > d, b < e, b < f, b < u,$$

$$c < d, c < e, c < f, c < u,$$

$$d < e, d < f, d < u,$$

$$e < u, f < u.$$

2. In [Example 10.2.3](#), state which of the following subsets of \mathbb{N} is linearly ordered:

(a) $\{21, 3, 7\}$;

(b) $\{3, 6, 15\}$;

(c) $\{2, 6, 12, 72\}$;

(d) $\{1, 2, 3, 4, 5, \dots\}$;

(e) $\{5\}$.

3. Let (X, \leq) be a linearly ordered set. If x and y are maximal elements of X , prove that $x = y$.
4. Let (X, \leq) be a partially ordered set. If x and y are greatest elements of X , prove that $x = y$.
5. Let $X = \{2, 3, 4, 5, 6, 7, 8, 9, 10\}$ be partially ordered as follows:

$$x \leq y \quad \text{if } y \text{ is a multiple of } x.$$

Draw an order diagram and find all the maximal elements of (X, \leq) . Does (X, \leq) have a greatest element?

6.* Using [Zorn's Lemma 10.2.16](#) prove that every vector space V has a basis.

[Hints: (i) Consider first the case where $V = \{0\}$.

(ii) Assume $V \neq \{0\}$ and define

$$\mathcal{B} = \{B : B \text{ is a set of linearly independent vectors of } V.\}$$

Prove that $\mathcal{B} \neq \emptyset$.

(iii) Define a partial order \leq on \mathcal{B} by

$$B_1 \leq B_2 \text{ if } B_1 \subseteq B_2.$$

Let $\{B_i : i \in I\}$ be any linearly ordered subset of \mathcal{B} . Prove that $A = \bigcup_{i \in I} B_i$ is a linearly independent set of vectors of V .

(iv) Deduce that $A \in \mathcal{B}$ and so is an upper bound for $\{B_i : i \in I\}$.

(v) Apply Zorn's Lemma to show the existence of a maximal element of \mathcal{B} . Prove that this maximal element is a basis for V .]

10.3 Tychonoff's Theorem

10.3.1 Definition. Let X be a set and \mathcal{F} a family of subsets of X . Then \mathcal{F} is said to have the **finite intersection property** or **(F.I.P.)** if for any finite number F_1, F_2, \dots, F_n of members of \mathcal{F} , $F_1 \cap F_2 \cap \dots \cap F_n \neq \emptyset$.

10.3.2 Proposition. Let (X, \mathcal{T}) be a topological space. Then (X, \mathcal{T}) is compact if and only if every family \mathcal{F} of closed subsets of X with the finite intersection property satisfies $\bigcap_{F \in \mathcal{F}} F \neq \emptyset$.

Proof. Assume that every family \mathcal{F} of closed subsets of X with the finite intersection property satisfies $\bigcap_{F \in \mathcal{F}} F \neq \emptyset$. Let \mathcal{U} be any open covering of X . Put \mathcal{F} equal to the family of complements of members of \mathcal{U} . So each $F \in \mathcal{F}$ is closed in (X, \mathcal{T}) . As \mathcal{U} is an open covering of X , $\bigcap_{F \in \mathcal{F}} F = \emptyset$. By our assumption, then, \mathcal{F} does not have the finite intersection property. So for some F_1, F_2, \dots, F_n in \mathcal{F} , $F_1 \cap F_2 \cap \dots \cap F_n = \emptyset$. Thus $U_1 \cup U_2 \cup \dots \cup U_n = X$, where $U_i = X \setminus F_i$, $i = 1, \dots, n$. So \mathcal{U} has a finite subcovering. Hence (X, \mathcal{T}) is compact.

The converse statement is proved similarly. □

10.3.3 Lemma. Let X be a set and \mathcal{F} a family of subsets of X with the finite intersection property. Then there is a maximal family of subsets of X that contains \mathcal{F} and has the finite intersection property.

Proof. Let \mathcal{Z} be the collection of all families of subsets of X which contain \mathcal{F} and have the finite intersection property. Define a partial order \leq on \mathcal{Z} as follows: if \mathcal{F}_1 and \mathcal{F}_2 are in \mathcal{Z} then put $\mathcal{F}_1 \leq \mathcal{F}_2$ if $\mathcal{F}_1 \subseteq \mathcal{F}_2$. Let Y be any linearly ordered subset of \mathcal{Z} . To apply [Zorn's Lemma 10.2.16](#) we need to verify that Y has an upper bound. We claim that $\bigcup_{\mathcal{Y} \in Y} \mathcal{Y}$ is an upper bound for Y . Clearly this contains \mathcal{F} , so we have to show only that it has the finite intersection property. So let $S_1, S_2, \dots, S_n \in \bigcup_{\mathcal{Y} \in Y} \mathcal{Y}$. Then each $S_i \in \mathcal{Y}_i$, for some $\mathcal{Y}_i \in Y$. As Y is linearly ordered, one of the \mathcal{Y}_i contains all of the others. Thus S_1, S_2, \dots, S_n all belong to that \mathcal{Y}_i . As \mathcal{Y}_i has the finite intersection property, $S_1 \cap S_2 \cap \dots \cap S_n \neq \emptyset$. Hence $\bigcup_{\mathcal{Y} \in Y} \mathcal{Y}$ has the finite intersection property and is, therefore, an upper bound in \mathcal{Z} of Y . Thus by [Zorn's Lemma](#), \mathcal{Z} has a maximal element. □

We can now prove the much heralded Tychonoff Theorem.

10.3.4 Theorem. (Tychonoff's Theorem) Let $\{(X_i, \mathcal{T}_i) : i \in I\}$ be any family of topological spaces. Then $\prod_{i \in I} (X_i, \mathcal{T}_i)$ is compact if and only if each (X_i, \mathcal{T}_i) is compact.

Proof. We shall use [Proposition 10.3.2](#) to show that $(X, \mathcal{T}) = \prod_{i \in I} (X_i, \mathcal{T}_i)$ is compact, if each (X_i, \mathcal{T}_i) is compact. Let \mathcal{F} be any family of closed subsets of X with the finite intersection property. We have to prove that $\bigcap_{F \in \mathcal{F}} F \neq \emptyset$.

By [Lemma 10.3.3](#) there is a maximal family \mathcal{H} of (not necessarily closed) subsets of (X, \mathcal{T}) that contains \mathcal{F} and has the finite intersection property. We shall prove that $\bigcap_{H \in \mathcal{H}} \overline{H} \neq \emptyset$, from which follows the required result $\bigcap_{F \in \mathcal{F}} F \neq \emptyset$, since each $F \in \mathcal{F}$ is closed.

As \mathcal{H} is maximal with the property that it contains \mathcal{F} and has the finite intersection property, if $H_1, H_2, \dots, H_n \in \mathcal{H}$, for any $n \in \mathbb{N}$, then the set $H' = H_1 \cap H_2 \cap \dots \cap H_n \in \mathcal{H}$. Suppose this was not the case. Then the set $\mathcal{H}' = \mathcal{H} \cup \{H'\}$ would properly contain \mathcal{H} and also have the property that it contains \mathcal{F} and has the finite intersection property. This is a contradiction to \mathcal{H} being maximal. So $\mathcal{H}' = \mathcal{H}$ and $H' = H_1 \cap H_2 \cap \dots \cap H_n \in \mathcal{H}$.

Let S be any subset of X that intersects non-trivially every member of \mathcal{H} . We claim that $\mathcal{H} \cup \{S\}$ has the finite intersection property. To see this let H'_1, H'_2, \dots, H'_m be members of \mathcal{H} . We shall show that $S \cap H'_1 \cap H'_2 \cap \dots \cap H'_m \neq \emptyset$. By the previous paragraph, $H'_1 \cap H'_2 \cap \dots \cap H'_m \in \mathcal{H}$. So by assumption $S \cap (H'_1 \cap H'_2 \cap \dots \cap H'_m) \neq \emptyset$. Hence $\mathcal{H} \cup \{S\}$ has the finite intersection property and contains \mathcal{F} . Again using the fact that \mathcal{H} is maximal with the property that it contains \mathcal{F} and has the finite intersection property, we see that $S \in \mathcal{H}$.

Fix $i \in I$ and let $p_i : \prod_{i \in I} (X_i, \mathcal{T}_i) \rightarrow (X_i, \mathcal{T}_i)$ be the projection mapping. Then the family $\{p_i(H) : H \in \mathcal{H}\}$ has the finite intersection property. Therefore the family $\{\overline{p_i(H)} : H \in \mathcal{H}\}$ has the finite intersection property. As (X_i, \mathcal{T}_i) is compact, $\bigcap_{H \in \mathcal{H}} \overline{p_i(H)} \neq \emptyset$. So let $x_i \in \bigcap_{H \in \mathcal{H}} \overline{p_i(H)}$. Then for each $i \in I$, we can find a point $x_i \in \bigcap_{H \in \mathcal{H}} \overline{p_i(H)}$. Put $x = \prod_{i \in I} x_i \in X$.

We shall prove that $x \in \bigcap_{H \in \mathcal{H}} \overline{H}$. Let O be any open set containing x . Then O contains a basic open set about x of the form $\bigcap_{i \in J} p_i^{-1}(U_i)$, where $U_i \in \mathcal{T}_i$, $x_i \in U_i$ and J is a finite subset of I . As $x_i \in \overline{p_i(H)}$, $U_i \cap p_i(H) \neq \emptyset$, for all $H \in \mathcal{H}$. Thus $p_i^{-1}(U_i) \cap H \neq \emptyset$, for all $H \in \mathcal{H}$. By the observation above, this implies that $p_i^{-1}(U_i) \in \mathcal{H}$, for all $i \in J$. As \mathcal{H} has the finite intersection property, $\bigcap_{i \in J} p_i^{-1}(U_i) \cap H \neq \emptyset$, for all $H \in \mathcal{H}$. So $O \cap H \neq \emptyset$ for all $H \in \mathcal{H}$. Hence $x \in \bigcap_{H \in \mathcal{H}} \overline{H}$, as required.

Conversely, if $\prod_{i \in I} (X_i, \mathcal{T}_i)$ is compact, then by [Propositions 7.2.1](#) and [10.1.5](#) (i) each (X_i, \mathcal{T}_i) is compact. \square

10.3.5 Notation. Let A be any set and for each $a \in A$ let the topological space (I_a, \mathcal{T}_a) be homeomorphic to $[0, 1]$. Then the product space $\prod_{a \in A} (I_a, \mathcal{T}_a)$ is denoted by I^A and referred to as a **cube**.

Observe that $I^{\mathbb{N}}$ is just the Hilbert cube which we also denote by I^∞ .

10.3.6 Corollary. For any set A , the cube I^A is compact.

10.3.7 Proposition. Let (X, d) be a metric space. Then it is homeomorphic to a subspace of the cube I^X .

Proof. Without loss of generality, assume $d(a, b) \leq 1$ for all a and b in X . For each $a \in X$, let f_a be the continuous mapping of (X, d) into $[0, 1]$ given by

$$f_a(x) = d(x, a).$$

That the family $\{f_a : a \in X\}$ separates points and closed sets is easily shown (cf. the proof of [Theorem 9.4.11](#)). Thus, by [Corollary 10.1.10 of the Embedding Lemma](#), (X, d) is homeomorphic to a subspace of the cube I^X . \square

This leads us to ask: Which topological spaces are homeomorphic to subspaces of cubes? We now address this question.

10.3.8 Definitions. Let (X, \mathcal{T}) be a topological space. Then (X, \mathcal{T}) is said to be **completely regular** if for each $x \in X$ and each open set $U \ni x$, there exists a continuous function $f: (X, \mathcal{T}) \rightarrow [0, 1]$ such that $f(x) = 0$ and $f(y) = 1$ for all $y \in X \setminus U$. If (X, \mathcal{T}) is also Hausdorff, then it is said to be **Tychonoff space** (or a $T_{3\frac{1}{2}}$ -space).

10.3.9 Proposition. Let (X, d) be a metric space and \mathcal{T} the topology induced on X by d . Then (X, \mathcal{T}) is a Tychonoff space.

Proof. Let $a \in X$ and U be any open set containing a . Then U contains an open ball with centre a and radius ε , for some $\varepsilon > 0$. Define $f : (X, d) \rightarrow [0, 1]$ by

$$f(x) = \min \left\{ 1, \frac{d(x, a)}{\varepsilon} \right\}, \quad \text{for } x \in X.$$

Then f is continuous and satisfies $f(a) = 0$ and $f(y) = 1$, for all $y \in X \setminus U$. As (X, d) is also Hausdorff, it is a Tychonoff space. \square

10.3.10 Corollary. The space $[0, 1]$ is a Tychonoff space. \square

10.3.11 Proposition. If $\{(X_i, \mathcal{T}_i) : i \in I\}$ is any family of completely regular spaces, then $\prod_{i \in I} (X_i, \mathcal{T}_i)$ is completely regular.

Proof. Let $a = \prod_{i \in I} a_i \in \prod_{i \in I} X_i$ and U be any open set containing a . Then there exists a finite subset J of I and sets $U_j \in \mathcal{T}_j$ such that

$$a \in \prod_{i \in I} U_i \subseteq U$$

where $U_i = X_i$ for all $i \in I \setminus J$. As (X_j, \mathcal{T}_j) is completely regular for each $j \in J$, there exists a continuous mapping $f_j : (X_j, \mathcal{T}_j) \rightarrow [0, 1]$ such that $f_j(a_j) = 0$ and $f_j(y) = 1$, for all $y \in X_j \setminus U_j$. Then $f_j \circ p_j : \prod_{i \in I} (X_i, \mathcal{T}_i) \rightarrow [0, 1]$, where p_j denotes the projection of $\prod_{i \in I} (X_i, \mathcal{T}_i)$ onto (X_j, \mathcal{T}_j) .

If we put $f(x) = \max\{f_j \circ p_j(x) : j \in J\}$, for all $x \in \prod_{i \in I} X_i$, then $f : \prod_{i \in I} (X_i, \mathcal{T}_i) \rightarrow [0, 1]$ is continuous (as J is finite). Further, $f(a) = 0$ while $f(y) = 1$ for all $y \in X \setminus U$. So $\prod_{i \in I} (X_i, \mathcal{T}_i)$ is completely regular. \square

The next proposition is easily proved and so its proof is left as an exercise.

10.3.12 Proposition. If $\{(X_i, \mathcal{T}_i) : i \in I\}$ is any family of Hausdorff spaces, then $\prod_{i \in I} (X_i, \mathcal{T}_i)$ is Hausdorff.

Proof. Exercise. □

10.3.13 Corollary. If $\{(X_i, \mathcal{T}_i) : i \in I\}$ is any family of Tychonoff spaces, then $\prod_{i \in I} (X_i, \mathcal{T}_i)$ is a Tychonoff space. □

10.3.14 Corollary. For any set X , the cube I^X is a Tychonoff space. □

10.3.15 Proposition. Every subspace of a completely regular space is completely regular.

Proof. Exercise. □

10.3.16 Corollary. Every subspace of a Tychonoff space is a Tychonoff space.

Proof. Exercise. □

10.3.17 Proposition. If (X, \mathcal{T}) is any Tychonoff space, then it is homeomorphic to a subspace of a cube.

Proof. Let \mathcal{F} be the family of all continuous mappings $f : (X, \mathcal{T}) \rightarrow [0, 1]$. Then it follows easily from Corollary 10.1.10 of the Embedding Lemma and the definition of completely regular, that the evaluation map $e : (X, \mathcal{T}) \rightarrow I^{\mathcal{F}}$ is an embedding. \square

Thus we now have a characterization of the subspaces of cubes. Putting together [Proposition 10.3.17](#) and [Corollaries 10.3.14](#) and [10.3.16](#) we obtain:

10.3.18 Proposition. A topological space (X, \mathcal{T}) can be embedded in a cube if and only if it is a Tychonoff space. \square

10.3.19 Remark. We now proceed to show that the class of Tychonoff spaces is quite large and, in particular, includes all compact Hausdorff spaces.

10.3.20 Definitions. A topological space (X, \mathcal{T}) is said to be a **normal space** if for each pair of disjoint closed sets A and B , there exist open sets U and V such that $A \subseteq U$, $B \subseteq V$ and $U \cap V = \emptyset$. A normal space which is also Hausdorff is said to be a **T_4 -space**.

10.3.21 Remarks. In [Exercises 6.1 #9](#) it is noted that every metrizable space is a normal space. A little later we shall verify that every compact Hausdorff space is normal. First we shall prove that every normal Hausdorff space is a Tychonoff space (that is, every T_4 -space is a $T_{3\frac{1}{2}}$ -space).

Putting $C = X \setminus B$, and $K = X \setminus V$ in [Definition 10.3.20](#) of a normal space, we see that **a topological space (X, \mathcal{T}) is a normal space if and only if for every closed set A and open set C with $A \subseteq C$, there exists a closed set K with $A \subseteq \text{Int}(K) \subseteq K \subseteq C$.**

10.3.22 Theorem. (Urysohn's Lemma) Let (X, \mathcal{T}) be a topological space. Then (X, \mathcal{T}) is normal if and only if for each pair of disjoint closed sets A and B in (X, \mathcal{T}) there exists a continuous function $f: (X, \mathcal{T}) \rightarrow [0, 1]$ such that $f(a) = 0$ for all $a \in A$, and $f(b) = 1$ for all $b \in B$.

Proof. Assume that for each A and B an f with the property stated above exists. Then $U = f^{-1}([0, \frac{1}{2}))$ and $V = f^{-1}((\frac{1}{2}, 1])$ are open in (X, \mathcal{T}) and satisfy $A \subseteq U$, $B \subseteq V$, and $A \cap B = \emptyset$. Hence (X, \mathcal{T}) is normal.

Conversely, assume (X, \mathcal{T}) is normal. We shall construct a family $\{U_i : i \in D\}$ of open subsets of X , where the set D is given by $D = \{\frac{k}{2^n} : k = 1, 2, \dots, 2^n, n \in \mathbb{N}\}$.

So D is a set of dyadic rational numbers, such that $A \subseteq U_i$, $U_i \cap B = \emptyset$, and $d_1 \leq d_2$ implies $U_{d_1} \subseteq U_{d_2}$. As (X, \mathcal{T}) is normal, for any pair A, B of disjoint closed sets, there exist disjoint open sets $U_{\frac{1}{2}}$ and $V_{\frac{1}{2}}$ such that $A \subseteq U_{\frac{1}{2}}$ and $B \subseteq V_{\frac{1}{2}}$. So we have $A \subseteq U_{\frac{1}{2}} \subseteq V_{\frac{1}{2}}^C \subseteq B^C$ where the superscript C is used to denote complements in X (that is, $V_{\frac{1}{2}}^C = X \setminus V_{\frac{1}{2}}$ and $B^C = X \setminus B$).

Now consider the disjoint closed sets A and $U_{\frac{1}{2}}^C$. Again, by normality, there exist disjoint open sets $U_{\frac{1}{4}}$ and $V_{\frac{1}{4}}$ such that $A \subseteq U_{\frac{1}{4}}$ and $U_{\frac{1}{2}}^C \subseteq V_{\frac{1}{4}}$. Also as $V_{\frac{1}{2}}^C$ and B are disjoint closed sets there exists disjoint open sets $U_{\frac{3}{4}}$ and $V_{\frac{3}{4}}$ such that $V_{\frac{1}{2}}^C \subseteq U_{\frac{3}{4}}$ and $B \subseteq V_{\frac{3}{4}}$. So we have

$$A \subseteq U_{\frac{1}{4}} \subseteq V_{\frac{1}{4}}^C \subseteq U_{\frac{1}{2}} \subseteq V_{\frac{1}{2}}^C \subseteq U_{\frac{3}{4}} \subseteq V_{\frac{3}{4}}^C \subseteq B^C.$$

Continuing by induction we obtain open sets U_d and V_d , for each $d \in D$, such that

$$A \subseteq U_{2^{-n}} \subseteq V_{2^{-n}}^C \subseteq U_{2 \cdot 2^{-n}} \subseteq V_{2 \cdot 2^{-n}}^C \subseteq \dots \subseteq U_{(2^{n-1})2^{-n}} \subseteq V_{(2^{n-1})2^{-n}}^C \subseteq B^C.$$

So we have, in particular, that for $d_1 \leq d_2$ in D , $U_{d_1} \subseteq U_{d_2}$.

Now we define $f: (X, \mathcal{T}) \rightarrow [0, 1]$ by $f(x) = \begin{cases} \inf\{d : x \in U_d\}, & \text{if } x \in \bigcup_{d \in D} U_d \\ 1, & \text{if } x \notin \bigcup_{d \in D} U_d. \end{cases}$

Observe finally that since $A \subseteq U_d$, for all $d \in D$, $f(a) = 0$ for all $a \in A$. Also if $b \in B$, then $b \notin \bigcup_{d \in D} U_d$ and so $f(b) = 1$. So we have to show only that f is continuous.

Let $f(x) = y$, where $y \neq 0, 1$ and set $W = (y - \varepsilon, y + \varepsilon)$, for some $\varepsilon > 0$ (with $0 < y - \varepsilon < y + \varepsilon < 1$). As D is dense in $[0, 1]$, we can choose d_0 and d_1 such that $y - \varepsilon < d_0 < y < d_1 < y_0 + \varepsilon$. Then, by the definition of f , $x \in U = U_{d_1} \setminus \bar{U}_{d_0}$ and the open set U satisfies $f(U) \subseteq W$. If $y = 1$ then we put $W = (y - \varepsilon, 1]$, choose d_0 such that $y - \varepsilon < d_0 < 1$, and set $U = X \setminus \bar{U}_{d_0}$. Again $f(U) \subseteq W$. Finally, if $y = 0$ then put $W = [0, y + \varepsilon)$, choose d_1 such that $0 < d_1 < Y + \varepsilon$ and set $U = U_{d_1}$ to again obtain $f(U) \subseteq W$. Hence f is continuous. \square

10.3.23 Corollary. If (X, \mathcal{T}) is a Hausdorff normal space then it is a Tychonoff space; that is, every T_4 -space is a $T_{3\frac{1}{2}}$ -space. Consequently it is homeomorphic to a subspace of a cube. \square

10.3.24 Proposition. Every compact Hausdorff space (X, \mathcal{T}) is normal.

Proof. Let A and B be disjoint closed subsets of (X, \mathcal{T}) . Fix $b \in B$. Then, as (X, \mathcal{T}) is Hausdorff, for each $a \in A$, there exist open sets U_a and V_a such that $a \in U_a$, $b \in V_a$ and $U_a \cap V_a = \emptyset$. So $\{U_a : a \in A\}$ is an open covering of A . As A is compact, there exists a finite subcovering $U_{a_1}, U_{a_2}, \dots, U_{a_n}$. Put $U_b = U_{a_1} \cup U_{a_2} \cup \dots \cup U_{a_n}$ and $V_b = V_{a_1} \cap V_{a_2} \cap \dots \cap V_{a_n}$. Then we have $A \subseteq U_b$, $b \in V_b$, and $U_b \cap V_b = \emptyset$. Now let b vary throughout B , so we obtain an open covering $\{V_b : b \in B\}$ of B . As B is compact, there exists a finite subcovering $V_{b_1}, V_{b_2}, \dots, V_{b_m}$. Set $V = V_{b_1} \cup V_{b_2} \cup \dots \cup V_{b_m}$ and $U = U_{b_1} \cap U_{b_2} \cap \dots \cap U_{b_m}$. Then $A \subseteq U$, $B \subseteq V$, and $U \cap V = \emptyset$. Hence (X, \mathcal{T}) is normal. \square

10.3.25 Corollary. Every compact Hausdorff space can be embedded in a cube. \square

10.3.26 Remark. We can now prove the Urysohn metrization theorem which provides a sufficient condition for a topological space to be metrizable. It also provides a necessary and sufficient condition for a compact space to be metrizable – namely that it be Hausdorff and second countable. \square

10.3.27 Definitions. A topological space (X, \mathcal{T}) is said to be **regular** if for each $x \in X$ and each $U \in \mathcal{T}$ such that $x \in U$, there exists a $V \in \mathcal{T}$ with $x \in \overline{V} \subseteq U$. If (X, \mathcal{T}) is also Hausdorff it is said to be a **T_3 -space**.

10.3.28 Remark. It is readily verified that every $T_{3\frac{1}{2}}$ -space is a T_3 -space. So, from [Corollary 10.3.23](#), every T_4 -space is a T_3 -space. Indeed we now have a hierarchy:

$$\text{compact Hausdorff} \Rightarrow T_4 \Rightarrow T_{3\frac{1}{2}} \Rightarrow T_3 \Rightarrow T_2 \Rightarrow T_1 \Rightarrow T_0$$

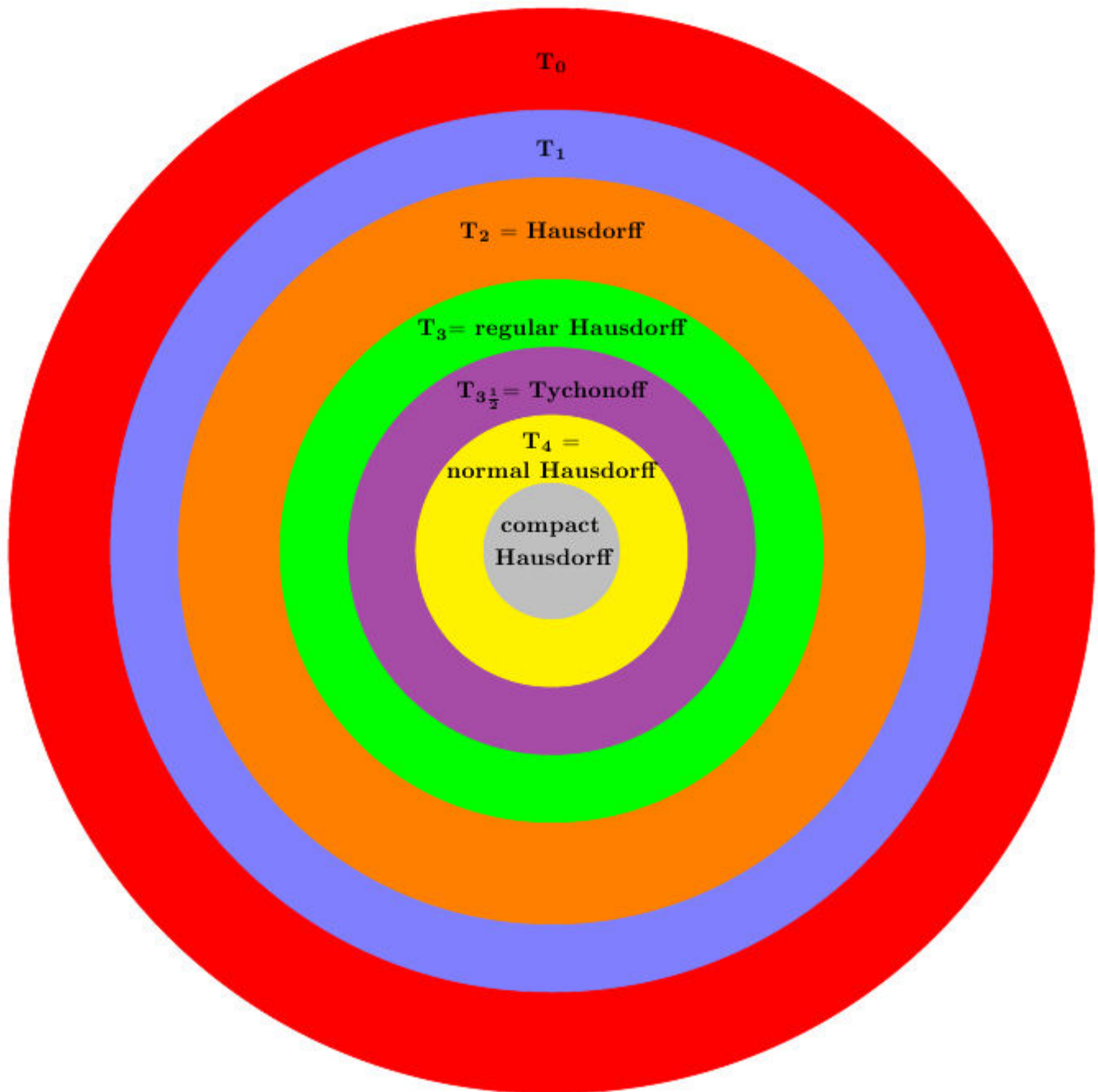

$$\text{metrizable} \Rightarrow T_4 \Rightarrow T_{3\frac{1}{2}} \Rightarrow T_3 \Rightarrow T_2 \Rightarrow T_1 \Rightarrow T_0.$$

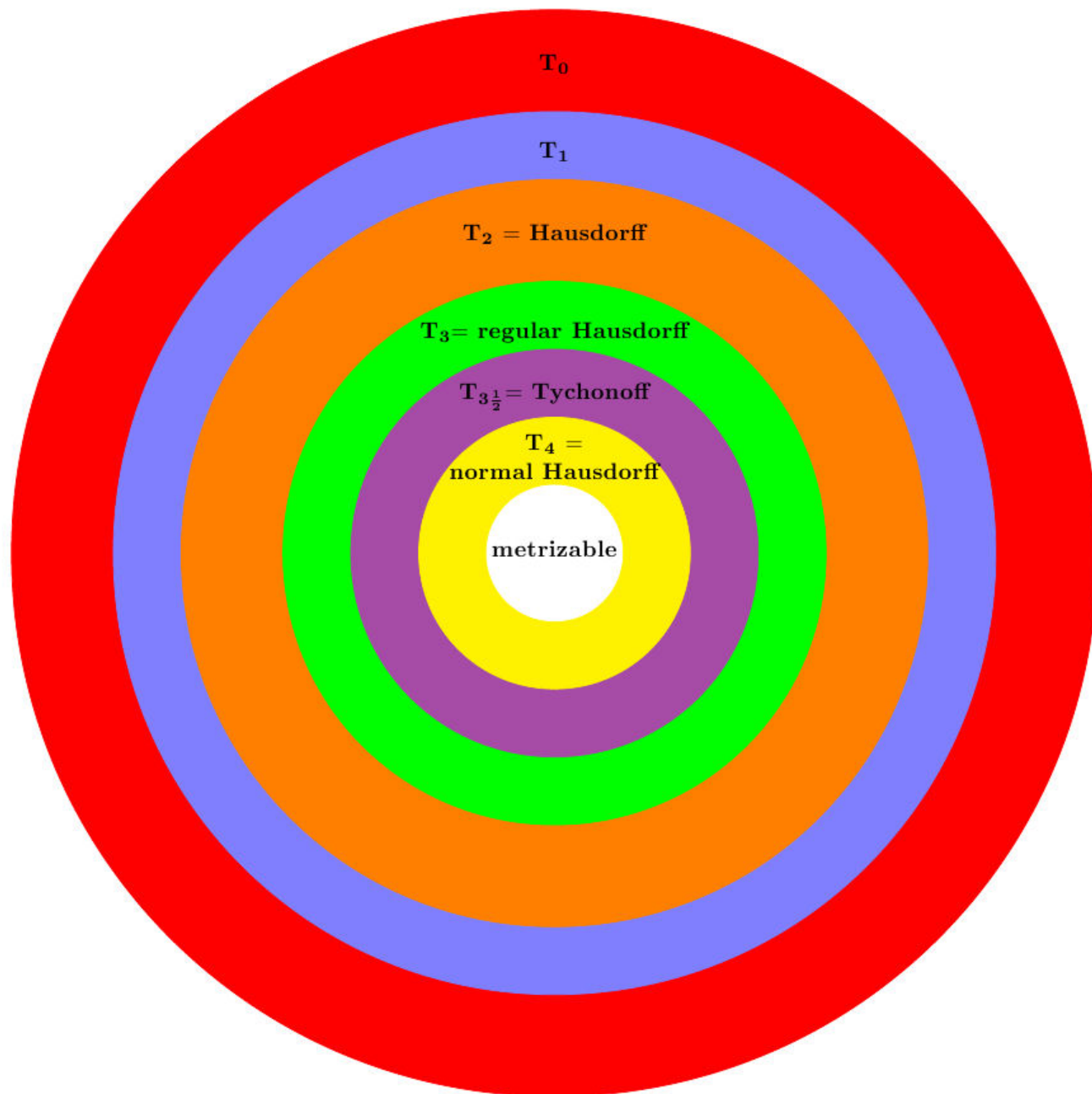

□

10.3.29 Proposition. Every normal second countable Hausdorff space (X, \mathcal{T}) is metrizable.

Proof. It suffices to show that (X, \mathcal{T}) can be embedded in the Hilbert cube I^∞ . By [Corollary 9.4.10](#), to verify this it is enough to find a countable family of continuous maps of (X, \mathcal{T}) into $[0, 1]$ which separates points and closed sets.

Let \mathcal{B} be a countable basis for \mathcal{T} , and consider the set \mathcal{S} of all pairs (V, U) such that $U \in \mathcal{B}$, $V \in \mathcal{B}$ and $\bar{V} \subseteq U$. Then \mathcal{S} is countable. For each pair (V, U) in \mathcal{S} we can, by [Urysohn's Lemma 10.3.22](#), find a continuous mapping $f_{VU}: (X, \mathcal{T}) \rightarrow [0, 1]$ such that $f_{VU}(\bar{V}) = 0$ and $f_{VU}(X \setminus U) = 1$. Put \mathcal{F} equal to the family of functions, f , so obtained. Then \mathcal{F} is countable.

To see that \mathcal{F} separates points and closed sets, let $x \in X$ and W any open set containing x . Then there exists a $U \in \mathcal{B}$ such that $x \in U \subseteq W$. By [Remark 10.3.28](#), (X, \mathcal{T}) is regular and so there exists a set $P \in \mathcal{T}$ such that $x \in P \subseteq \bar{P} \subseteq U$. Therefore there exists a $V \in \mathcal{B}$ with $x \in V \subseteq P$. So $x \in \bar{V} \subseteq \bar{P} \subseteq U$. Then $(V, U) \in \mathcal{S}$ and if f_{VU} is the corresponding mapping in \mathcal{F} , then $f_{VU}(x) = 0 \notin \{1\} = \overline{f_{VU}(X \setminus W)}$. \square

10.3.30 Lemma. Every regular second countable space (X, \mathcal{T}) is normal.

Proof. Let A and B be disjoint closed subsets of (X, \mathcal{T}) and \mathcal{B} a countable basis for \mathcal{T} . As (X, \mathcal{T}) is regular and $X \setminus B$ is an open set, for each $a \in A$ there exists a $V_a \in \mathcal{B}$ such that $\bar{V}_a \subseteq X \setminus B$.

As \mathcal{B} is countable we can list the members $\{V_a : a \in A\}$ so obtained by $V_i, i \in \mathbb{N}$; that is, $A \subseteq \bigcup_{i=1}^{\infty} V_i$ and $\bar{V}_i \cap B = \emptyset$, for all $i \in \mathbb{N}$.

Similarly we can find sets U_i in $\mathcal{B}, i \in \mathbb{N}$, such that $B \subseteq \bigcup_{i=1}^{\infty} U_i$ and $\bar{U}_i \cap A = \emptyset$, for all $i \in \mathbb{N}$.

Now define $U'_1 = U_1 \setminus \bar{V}_1$ and $V'_1 = V_1 \setminus \bar{U}_1$.

So $U'_1 \cap V'_1 = \emptyset, U'_1 \in \mathcal{T}, V'_1 \in \mathcal{T}, U'_1 \cap B = U_1 \cap B,$ and $V'_1 \cap A = V_1 \cap A$.

Then we inductively define

$$\bar{U}'_n = U_n \setminus \bigcup_{i=1}^n \bar{V}_i \quad \text{and} \quad V'_n = V_n \setminus \bigcup_{i=1}^n \bar{U}_i$$

So that $U'_n \in \mathcal{T}, V'_n \in \mathcal{T}, U'_n \cap B = U_n \cap B,$ and $V'_n \cap A = A_n \cap A$.

Now put $U = \bigcup_{n=1}^{\infty} U'_n$ and $V = \bigcup_{n=1}^{\infty} V'_n$.

Then $U \cap V = \emptyset, U \in \mathcal{T}, V \in \mathcal{T}, A \subseteq V,$ and $B \subseteq U$.

Hence (X, \mathcal{T}) is a normal space. □

We can now deduce from [Proposition 10.3.29](#) and [Lemma 10.3.30](#) the Urysohn Metrization Theorem, which generalizes [Proposition 10.3.29](#).

10.3.31 Theorem. (Urysohn's Metrization Theorem) Every regular second countable Hausdorff space is metrizable. □

From Urysohn's Metrization Theorem, [Proposition 9.4.4](#), and [Proposition 9.4.17](#), we deduce the following characterization of metrizability for compact spaces.

10.3.32 Corollary. A compact space is metrizable if and only if it is Hausdorff and second countable. □

10.3.33 Remark. As mentioned in [Remark 10.3.21](#), every metrizable space is normal. It then follows from [Proposition 9.4.17](#) that every separable metric space is normal, Hausdorff, and second countable. Thus [Uryshohn's Theorem 9.4.11](#), which says that every separable metric space is homeomorphic to a subspace of the Hilbert cube, is a consequence of (the proof of) [Proposition 10.3.29](#).

10.3.34 Remark. There are some surprises in store as regards products of separable spaces. You might reasonably expect that a finite product of separable spaces is separable. Indeed it would not be unexpected to hear that a countable product of separable spaces is separable eg \mathbb{N}^{\aleph_0} and \mathbb{R}^{\aleph_0} are separable. And these are all true. But it would be surprising to hear that $\mathbb{R}^{\mathfrak{c}}$ is separable. All these follow from the Hewitt-Marczewski-Pondiczery Theorem (Hewitt [[179](#)]; Marczewski [[276](#)]; Pondiczery [[329](#)]) below, due to Edwin Hewitt (1920–1999), Edward Marczewski (1907–1976) and E.S. Pondiczery.¹ This theorem is not only surprising but also very informative, as we shall see, in the next section as it will tell us that the Stone-Čech compactification of many spaces are in fact huge. \square

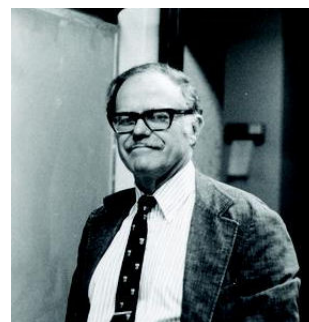

Hewitt



Marczewski

¹E.S. Pondiczery was a pseudonym invented by Ralph P. Boas Jr, Frank Smithies and colleagues.

10.3.35 Lemma. Let (D, \mathcal{T}_d) be a discrete topological space, \mathcal{F} the set of all finite subsets of D and for each $F \in \mathcal{F}$, let \mathcal{T}_F be the discrete topology on F so that (F, \mathcal{T}_F) is a subspace of (D, \mathcal{T}_d) . Let I be any index set and A_F a dense subset of the product space $(F, \mathcal{T}_F)^I$, for each $F \in \mathcal{F}$. If $A = \bigcup_{F \in \mathcal{F}} A_F$, then A is a dense subset of $(D, \mathcal{T}_d)^I$.

Proof. Let U be any open set in $(D, \mathcal{T}_d)^I$. Since (D, \mathcal{T}_d) is discrete, the definition of the product topology, [Definition 10.1.1](#), shows that there exists $i_1, i_2, \dots, i_k \in I$ and $x_{i_1}, x_{i_2}, \dots, x_{i_k} \in D$ such that

$$U \supseteq \{x_{i_1}\} \times \{x_{i_2}\} \times \dots \times \{x_{i_k}\} \times D^{I \setminus \{i_1, i_2, \dots, i_k\}}.$$

Put $F = \{x_{i_1}, x_{i_2}, \dots, x_{i_k}\}$. As A_F is dense in $(F, \mathcal{T}_F)^I$ and $\{x_{i_1}\} \times \{x_{i_2}\} \times \dots \times \{x_{i_k}\} \times F^{I \setminus \{i_1, i_2, \dots, i_k\}}$ is an open set in $(F, \mathcal{T}_F)^I$,

$$\{x_{i_1}\} \times \{x_{i_2}\} \times \dots \times \{x_{i_k}\} \times F^{I \setminus \{i_1, i_2, \dots, i_k\}} \cap A_F \neq \emptyset.$$

This implies

$$\{x_{i_1}\} \times \{x_{i_2}\} \times \dots \times \{x_{i_k}\} \times D^{I \setminus \{i_1, i_2, \dots, i_k\}} \cap A_F \neq \emptyset.$$

This in turn implies that $U \cap A_F \neq \emptyset$, and so $U \cap A \neq \emptyset$. Hence A is indeed dense in $(D, \mathcal{T}_d)^I$, as required. \square

10.3.36 Proposition. Let m be an infinite cardinal number and let the topological space $(X, \mathcal{T}) = \{0, 1\}^{2^m}$ be the product of 2^m copies of the discrete space $\{0, 1\}$. Then (X, \mathcal{T}) has a dense subspace of cardinality $\leq m$.

Proof. Let M be a set with $\text{card } M = m$. The power set $\mathcal{P}(M)$ has $\text{card } (\mathcal{P}(M)) = 2^m$.

We are required to find a dense subset Y of (X, \mathcal{T}) of cardinality $\leq m$. It suffices to find a set S and a function $\phi : S \rightarrow X$ with $\phi(S)$ a dense subset of (X, \mathcal{T}) and $\text{card } (S) = m$.

Let $\mathcal{F}(M)$ be the set of all finite subsets of M . So $\text{card } (\mathcal{F}(M)) = m$. (Exercise.) Let $\mathcal{F}(\mathcal{F}(M))$ be the set of all finite subsets of $\mathcal{F}(M)$. Then $\text{card } (\mathcal{F}(\mathcal{F}(M))) = m$. Put $S = \mathcal{F}(M) \times \mathcal{F}(\mathcal{F}(M))$. So $\text{card } (S) = m$.

We are now looking for a function ϕ of S into X . Recall that $X = \{0, 1\}^{2^m} = \{0, 1\}^{\mathcal{P}(M)}$, and $\{0, 1\}^{\mathcal{P}(M)}$ is the set of all functions from $\mathcal{P}(M)$ to $\{0, 1\}$. So for every subset T of S , $\phi(T)$ is a function from $\mathcal{P}(M)$ to $\{0, 1\}$.

Let N be a subset of M ; that is, $N \in \mathcal{P}(M)$. Further, let $F \in \mathcal{F}(M)$ and $\mathbb{F} \in \mathcal{F}(\mathcal{F}(M))$.

$$\text{Define } \phi : S \rightarrow X \text{ by } \phi(F, \mathbb{F})(N) = \begin{cases} 1, & \text{if } N \cap F \in \mathbb{F} \\ 0, & \text{if } N \cap F \notin \mathbb{F}. \end{cases}$$

Let $x \in X$ and let $N_j, j \in J$, be a finite number of distinct subsets of M . Put $K = \{(j_1, j_2) : j_1, j_2 \in J, j_1 \neq j_2\}$ and for each $(j_1, j_2) \in K$, define

$$T_{j_1 j_2} = (N_{j_1} \cup N_{j_2}) \setminus (N_{j_1} \cap N_{j_2}).$$

Let $\sigma : K \rightarrow \bigcup_{(j_1, j_2) \in K} T_{j_1, j_2}$ be any map such that $\sigma(j_1, j_2) \in T_{j_1 j_2}, (j_1, j_2) \in K$.

Set $\mathbb{F} = \{N_j \cap \sigma(K) : j \in J \text{ and } x(N_j) = 1\}$.

[Recall that $x \in \{0, 1\}^{\mathcal{P}(M)}$, that is x is a mapping from $\mathcal{P}(M)$ to $\{0, 1\}$.]

Then it is readily verified that $\phi(\sigma(K), \mathbb{F})(N_j) = x(N_j)$, for all $j \in J$, which completes the proof. ² □

²The proof here of this proposition is based on that in Blair [46] which is closely related to that of Theorem 9.2 of Gillman and Jerison [156] that every infinite set, X , has $2^{2^{\text{card}(X)}}$ distinct ultrafilters. See also Proposition A6.4.11.

10.3.37 Definition. Let (X, \mathcal{T}) be a topological space and let m be the least cardinal number such that (X, \mathcal{T}) has a dense subset of cardinality m . Then (X, \mathcal{T}) is said to have **density character** m .

Clearly a topological space is separable if and only if its density character is less than or equal to \aleph_0 .

So we can restate [Proposition 10.3.36](#) in the following way.

10.3.38 Proposition. For any infinite cardinal m , the topological space $(X, \mathcal{T}) = \{0, 1\}^{2^m}$ has density character at most m .

10.3.39 Corollary. For any infinite cardinal m and any finite discrete space (F, \mathcal{T}_F) , the product space $(X, \mathcal{T}) = (F, \mathcal{T}_F)^{2^m}$ has density character at most m .

Proof. Let n be a positive integer such that $2^n > \text{card } F$ and let f be any (continuous) map of the discrete space $\{0, 1\}^n$ onto the discrete space (F, \mathcal{T}_F) . Then there is a continuous map of $(\{0, 1\}^n)^{2^m}$ onto $(F, \mathcal{T}_F)^{2^m}$. As n is finite and m is an infinite cardinal, it is easily checked that $(\{0, 1\}^n)^{2^m}$ is homeomorphic to $\{0, 1\}^{2^m}$. So there is a continuous map of $\{0, 1\}^{2^m}$ onto $(F, \mathcal{T}_F)^{2^m}$. As the image under a continuous map of a dense subset is a dense subset of the image, it follows that the density character of $(F, \mathcal{T}_F)^{2^m}$ is less than or equal to the density character of $\{0, 1\}^{2^m}$, which by [Proposition 10.3.38](#) is less than or equal to m , as required. \square

10.3.40 Proposition. Let (D, \mathcal{T}_d) be a discrete topological space of cardinality less than or equal to m , for m any infinite cardinal number. Then $(D, \mathcal{T}_d)^{2^m}$ has density character less than or equal to m .

Proof. This follows immediately from [Lemma 10.3.35](#) and [Corollary 10.3.39](#). \square

10.3.41 Theorem. (Hewitt-Marczewski-Pondiczery Theorem) Let m be an infinite cardinal number, I a set of cardinality less than or equal to 2^m , and (X_i, \mathcal{T}_i) , $i \in I$, topological spaces each of density character less than or equal to m . Then the density character of the product space $\prod_{i \in I} (X_i, \mathcal{T}_i)$ is less than or equal to m .

In particular, if (X, \mathcal{T}) is any topological space of density character less than or equal to m , then the density character of the product space $(X, \mathcal{T})^{2^m}$ is less than or equal to m .

Proof. By Proposition 10.3.40 each (X_i, \mathcal{T}_i) has a dense subset which is a continuous image of the discrete space (D, \mathcal{T}_d) of cardinality m and so $\prod_{i \in I} (X_i, \mathcal{T}_i)$ has a dense subset which is a continuous image of the product space $(D, \mathcal{T}_d)^{2^m}$. As $(D, \mathcal{T}_d)^{2^m}$ has a dense subset of cardinality less than or equal to m , the product space $\prod_{i \in I} (X_i, \mathcal{T}_i)$ also has a dense subset of cardinality less than or equal to m ; that is, it has density character less than or equal to m . \square

10.3.42 Corollary. If (X, \mathcal{T}) is a separable topological space, then $(X, \mathcal{T})^{\mathfrak{c}}$ is a separable space. In particular, $\mathbb{R}^{\mathfrak{c}}$ is separable.

We shall conclude this section with extension theorems; the first and most important is the Tietze Extension Theorem which is of interest in itself, but also is useful in our study of the Stone–Čech compactification in the next section. We shall prove various special cases of the Tietze Extension Theorem before stating it in full generality.

10.3.43 Proposition. Let (X, \mathcal{T}) be a Hausdorff topological space. The following conditions are equivalent:

- (i) (X, \mathcal{T}) is normal;
- (ii) for every closed subspace (S, \mathcal{T}_1) of (X, \mathcal{T}) and each continuous map ϕ of (S, \mathcal{T}_1) into the closed unit interval $[0, 1]$ with the euclidean topology, there exists a continuous extension $\Phi : (X, \mathcal{T}) \rightarrow [0, 1]$ of ϕ .

Proof. ³ Assume that (ii) is true. Let A and B be disjoint closed subsets of (X, \mathcal{T}) . Put $S = A \cup B$ and define $\phi : S \rightarrow \mathbb{R}$ by $\phi(x) = 0$, for $x \in A$, and $\phi(x) = 1$, for $x \in B$. Then clearly $\phi : (A \cup B, \mathcal{T}_1) \rightarrow \mathbb{R}$ is continuous, where \mathcal{T}_1 is the subspace topology of $A \cup B$ from (X, \mathcal{T}) . By hypothesis, there exists a continuous map $\Phi : (X, \mathcal{T}) \rightarrow \mathbb{R}$ which extends ϕ . Let U and V be disjoint open sets in \mathbb{R} containing 0 and 1, respectively. Then $\Phi^{-1}(U)$ and $\Phi^{-1}(V)$ are disjoint open sets containing A and B , respectively. So (X, \mathcal{T}) is indeed a normal topological space; that is, (i) is true.

Now assume that (i) is true. Firstly let us consider the case that $\phi : (S, \mathcal{T}_1) \rightarrow [0, 1]$. Define $S_r = \{x \in S : \phi(x) \leq r\}$, for $r \in \mathbb{Q}$, and $T_s = X \setminus \{x \in S : \phi(x) \geq s\}$, for $s \in \mathbb{Q} \cap (0, 1)$. We define the index set P by $P = \{(r, s) : r, s \in \mathbb{Q} \text{ with } 0 \leq r < s < 1\}$. For convenience write $P = \{(r_n, s_n) : n \in \mathbb{N}\}$. For brevity we shall denote the interior, $\text{Int}(Y)$, in (X, \mathcal{T}) of any subset Y of X by Y^0 .

Our proof will use definition by mathematical induction. Noting that S_{r_1} is a closed set, T_{s_1} is an open set, $S_{r_1} \subseteq T_{s_1}$ and (X, \mathcal{T}) is normal, [Remark 10.3.21](#) shows that there exists a closed set H_1 in (X, \mathcal{T}) such that $S_{r_1} \subseteq H_1^0 \subseteq H_1 \subseteq T_{s_1}$. Next, assume that closed sets H_k have been constructed for all $k < n \in \mathbb{N}$ such that

$$S_{r_k} \subseteq H_k^0 \subseteq H_k \subseteq T_{s_k}, \text{ for } k < n, \quad (1)$$

$$\text{and } H_j \subseteq H_k^0, \text{ when } j, k < n, r_j < r_k \text{ and } s_j < s_k. \quad (2)$$

Define $J = \{j : j < n, r_j < r_n, \text{ and } s_j < s_n\}$ and $K = \{k : k < n, r_n < r_k, \text{ and } s_n < s_k\}$.

³The proof here is based on that of Mandelkern [275]. In the literature there are alternative proofs using uniform continuity.

Noting the definitions of S_r and T_s and using (1) and (2), we can apply [Remark 10.3.21](#), with $A = S_{r_n} \cup \bigcup_{j \in J} H_j$ and $C = T_{s_n} \cap \bigcap_{k \in K} H_k^0$, to show that there exists a closed set H_n in (X, \mathcal{T}) such that

$$S_{r_n} \cup \bigcup_{j \in J} H_j \subseteq H_n^0 \subseteq H_n \subseteq T_{s_n} \cap \bigcap_{k \in K} H_k^0. \tag{3}$$

From this equation (3) one can verify that

$$S_{r_k} \subseteq H_k^0 \subseteq H_k \subseteq T_{s_k}, \text{ for } k < n + 1, \tag{1'}$$

$$\text{and } H_j \subseteq H_k^0, \text{ when } j, k < n + 1, r_j < r_k \text{ and } s_j < s_k. \tag{2'}$$

Equations (1), (2), (1') and (2') complete our inductive definition of the closed sets H_n .

Now we write H_{rs} for H_n where $r = r_n$ and $s = s_n$. So that we have closed sets H_{rs} , for $(r, s) \in P$, with

$$S_r \subseteq H_{rs}^0 \subseteq H_{rs} \subseteq T_s, \text{ for } (r, s) \in P, \tag{4}$$

$$\text{and } H_{rs} \subseteq H_{tu}^0, \text{ when } r < t \text{ and } s < u. \tag{5}$$

Now define X_r as follows:

$$X_r = \begin{cases} X, & r \geq 1 \\ \emptyset, & r < 0 \\ \bigcap_{s > r} H_{rs}, & r \in \mathbb{Q} \cap [0, 1) \end{cases} \tag{6}$$

For $(r, s) \in P$, choose t such that $r < t < s$. Then by (6) and (5),

$$X_r \subseteq H_{rt} \subseteq H_{ts}^0 \subseteq H_{ts} \subseteq \bigcap_{u > s} H_{su} = X_s \tag{7}$$

From (7) we deduce that

$$X_r \subseteq X_s^0, \text{ for } (r, s) \in P \text{ with } r < s. \tag{8}$$

From the definitions of S_r & T_r , and equations (4) and (6) we have:

$$S_r \subseteq S \cap X_r = S \cap \bigcap_{s > r} H_{rs} \subseteq S \cap \bigcap_{s > r} T_s = S_r, \text{ for } r \in \mathbb{Q} \cap [0, 1). \tag{9}$$

So by (8) and noting that all the set containments in (9) are actually equality, we have found closed subsets $\{X_r : r \in \mathbb{Q}\}$ of (X, \mathcal{T}) with the properties:

$$\text{for } r, s \in \mathbb{Q}, r < s, X_r \subseteq X_s^0, \text{ and } X_r \cap S = S_r. \tag{10}$$

Finally define $\Phi(x) = \inf\{r : x \in X_r\}$, $x \in X$. By (6), $\Phi : (X, \mathcal{T}) \rightarrow [0, 1]$, and since $\phi(x) = \inf\{r : x \in S_r\}$, we have $\Phi(x) = \phi(x)$, for all $x \in S$; that is, Φ is an extension of ϕ . If $a, b \in \mathbb{R}$ with $a < b$, then it follows immediately from the definition of Φ that $\Phi^{-1}((a, b)) = \bigcup\{X_s^0 \setminus X_r : r, s \in \mathbb{Q} \text{ and } a < r < s < b\}$, and so Φ is continuous; that is, Φ is a continuous extension of ϕ , as required. \square

10.3.44 Proposition. Let (X, \mathcal{T}) be a Hausdorff topological space. The following conditions are equivalent:

- (i) (X, \mathcal{T}) is normal;
- (ii) for every closed subspace (S, \mathcal{T}_1) of (X, \mathcal{T}) and each continuous map ϕ of (S, \mathcal{T}_1) into the open unit interval $(0, 1)$ with the euclidean topology, there exists a continuous extension $\Phi : (X, \mathcal{T}) \rightarrow (0, 1)$ of ϕ .

Proof. That (ii) implies (i) is proved analogously to that in [Proposition 10.3.43](#).

So assume that (i) is true and that ϕ is a continuous map of (S, \mathcal{T}_1) into $(0, 1)$. We want to find a continuous map $\Gamma : X \rightarrow (0, 1)$ such that $\Gamma(x) = \phi(x)$, for all $x \in S$. By [Proposition 10.3.43](#), there exists a continuous map $\Phi : (X, \mathcal{T}) \rightarrow [0, 1]$, such that $\Phi(x) = \phi(x)$, for all $x \in X$.

Let $D = \{x : x \in X, \Phi(x) \in \{0, 1\}\}$. Then S and D are disjoint closed sets. As (X, \mathcal{T}) is a normal space, by [Urysohn's Lemma 10.3.22](#), there exists a continuous map $\theta : (X, \mathcal{T}) \rightarrow [\frac{1}{2}, 1]$ such that $\theta(x) = 1$ for all $x \in S$, and $\theta(x) = \frac{1}{2}$ for all $x \in D$. So if we define $\Gamma : (X, \mathcal{T}) \rightarrow (0, 1)$ by $\Gamma(x) = \Phi(x) \cdot \theta(x) \cdot \theta(x) + 1 - \theta(x)$, we can easily verify that Γ is a continuous extension of ϕ , as required. \square

10.3.45 Lemma. Let (S, \mathcal{T}_1) be a subspace of the topological space (X, \mathcal{T}) and (Y, \mathcal{T}_2) and (Z, \mathcal{T}_3) homeomorphic topological spaces. If every continuous map $\phi : (S, \mathcal{T}_1) \rightarrow (Y, \mathcal{T}_2)$ has a continuous extension $\Phi : (X, \mathcal{T}) \rightarrow (Y, \mathcal{T}_2)$, then every continuous map $\gamma : (S, \mathcal{T}_2) \rightarrow (Z, \mathcal{T}_3)$ also has a continuous extension $\Gamma : (X, \mathcal{T}) \rightarrow (Z, \mathcal{T}_3)$.

Proof. Exercise.

As an immediate consequence of [Proposition 10.3.44](#) and [Lemma 10.3.45](#) we have:

10.3.46 Proposition. Let (X, \mathcal{T}) be a Hausdorff topological space. The following conditions are equivalent:

- (i) (X, \mathcal{T}) is normal;
- (ii) for every closed subspace (S, \mathcal{T}_1) of (X, \mathcal{T}) and each continuous map ϕ of $(S, \mathcal{T}_1) \rightarrow \mathbb{R}$, there exists a continuous extension $\Phi : (X, \mathcal{T}) \rightarrow \mathbb{R}$ of ϕ . \square

10.3.47 Definition. Let (Y, \mathcal{T}_1) be a subspace of a topological space (X, \mathcal{T}) . Then (Y, \mathcal{T}_1) is said to be a **retract** of (X, \mathcal{T}) if there exists a continuous map $\theta : (X, \mathcal{T}) \rightarrow (Y, \mathcal{T}_1)$ with the property that $\theta(y) = y$, for all $y \in Y$.

10.3.48 Example. $[0, 1]$ is a retract of \mathbb{R} . (Verify this.) \square

10.3.49 Lemma. Let (S, \mathcal{T}_1) be a subspace of the topological space (X, \mathcal{T}) . Further, let (Y, \mathcal{T}_2) and (Z, \mathcal{T}_3) be topological spaces such that (Z, \mathcal{T}_3) is a retract of (Y, \mathcal{T}_2) . If every continuous map $\phi : (S, \mathcal{T}_1) \rightarrow (Y, \mathcal{T}_2)$ has a continuous extension $\Phi : (X, \mathcal{T}) \rightarrow (Y, \mathcal{T}_2)$, then every continuous map $\gamma : (S, \mathcal{T}_1) \rightarrow (Z, \mathcal{T}_3)$ also has a continuous extension $\Gamma : (X, \mathcal{T}) \rightarrow (Z, \mathcal{T}_3)$.

Proof. Let $\gamma : (S, \mathcal{T}_1) \rightarrow (Z, \mathcal{T}_3)$ be any continuous map. As (Z, \mathcal{T}_3) is a retract of (Y, \mathcal{T}_2) , there exists a continuous map $\theta : (Y, \mathcal{T}_2) \rightarrow (Z, \mathcal{T}_3)$ with $\theta(z) = z$, for all $z \in Z$.

As γ is also a continuous map of (S, \mathcal{T}_1) into (Y, \mathcal{T}_2) , by assumption there exists a continuous extension $\Phi : (X, \mathcal{T}) \rightarrow (Y, \mathcal{T}_2)$ of γ . Putting $\Gamma = \theta \circ \Phi$, we have that $\Gamma : (X, \mathcal{T}) \rightarrow (Z, \mathcal{T}_3)$ is a continuous extension of $\gamma : (S, \mathcal{T}_1) \rightarrow (Z, \mathcal{T}_3)$, as required. \square

10.3.50 Lemma. Let (S, \mathcal{T}_1) be a subspace of the topological space (X, \mathcal{T}) . Let I be any index set and (Y_i, \mathcal{T}_i) , $i \in I$, a set of topological spaces. If every continuous mapping $\phi_i : (S, \mathcal{T}_1) \rightarrow (Y_i, \mathcal{T}_i)$, $i \in I$, has a continuous extension $\Phi_i : (X, \mathcal{T}) \rightarrow (Y_i, \mathcal{T}_i)$, then the product map $\phi : (S, \mathcal{T}_1) \rightarrow \prod_{i \in I} (Y_i, \mathcal{T}_i)$, given by $\phi(x) = \prod_{i \in I} \phi_i(x)$, $x \in S$, has a continuous extension $\Phi : (X, \mathcal{T}) \rightarrow \prod_{i \in I} (Y_i, \mathcal{T}_i)$.

Proof. Defining Φ to be the product map of the Φ_i , $i \in I$, immediately yields the result. \square

Finally, using [Lemmas 10.3.50](#) and [10.3.49](#), [Proposition 10.3.46](#) and [Example 10.3.48](#), we obtain (a rather general version of) the Tietze Extension Theorem.

10.3.51 Theorem. (Tietze Extension Theorem) Let (X, \mathcal{T}) be a Hausdorff topological space, m any cardinal number, and (Y, \mathcal{T}_2) any infinite topological space which is a retract of the product space \mathbb{R}^m . The following conditions are equivalent:

- (i) (X, \mathcal{T}) is normal;
- (ii) for every closed subspace (S, \mathcal{T}_1) of (X, \mathcal{T}) and each continuous map ϕ of (S, \mathcal{T}_1) into (Y, \mathcal{T}_2) , there exists a continuous extension $\Phi : (X, \mathcal{T}) \rightarrow (Y, \mathcal{T}_2)$ of the map ϕ .

In particular, this is the case when (Y, \mathcal{T}_2) is any non-trivial interval in \mathbb{R} . \square

10.3.52 Remark. The condition in [Theorem 10.3.51\(ii\)](#) that (S, \mathcal{T}_1) is closed in (X, \mathcal{T}) is necessary. For example let $\phi : (0, 1] \rightarrow \mathbb{R}$ be the map $\phi(x) = \sin \frac{1}{x}$, for $x \in (0, 1]$. Then ϕ is continuous, but there is no extension of ϕ to a map $\Phi : [0, 1] \rightarrow \mathbb{R}$ which is continuous. (Verify this.)

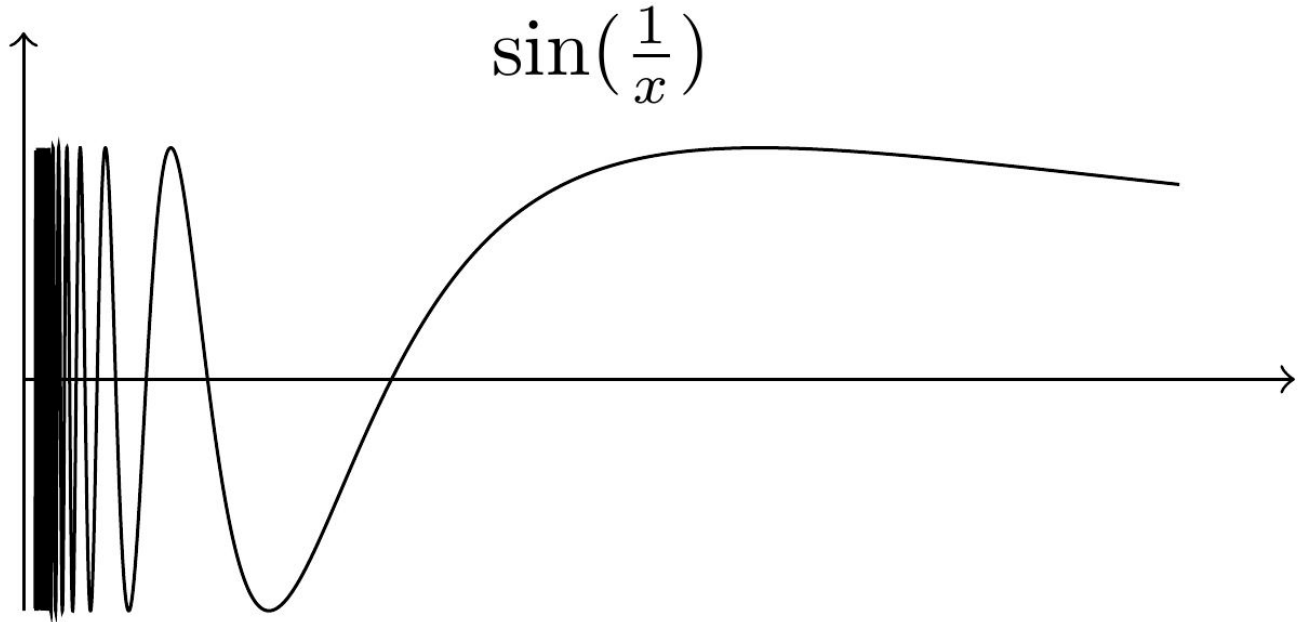

□

We end this section with a useful result on extending continuous maps from a dense subspace which shall be useful in our discussion of the Wallman compactification in [§A6.4 of Appendix 6](#)

10.3.53 Proposition. Let (S, \mathcal{T}_1) be a dense subspace of a topological space (X, \mathcal{T}) and $\phi : (S, \mathcal{T}_1) \rightarrow (K, \mathcal{T}_2)$ a continuous map of (S, \mathcal{T}_1) into a compact Hausdorff space (K, \mathcal{T}_2) . The following conditions are equivalent:

- (i) the map ϕ has a continuous extension $\Phi : (X, \mathcal{T}) \rightarrow (K, \mathcal{T}_2)$;
- (ii) for every pair of closed subsets C_1, C_2 of (K, \mathcal{T}_2) , the inverse images $\phi^{-1}(C_1)$ and $\phi^{-1}(C_2)$ have disjoint closures in (X, \mathcal{T}) .

Proof. Firstly assume (i) is true, that is the continuous extension Φ exists. By continuity, $\Phi^{-1}(C_1)$ and $\Phi^{-1}(C_2)$ are closed disjoint sets in (X, \mathcal{T}) . So

$$\overline{\Phi^{-1}(C_1)} \cap \overline{\Phi^{-1}(C_2)} = \Phi^{-1}(C_1) \cap \Phi^{-1}(C_2) = \emptyset.$$

Hence (ii) is true.

Now assume that (ii) is true. For every $x \in X$, let $\mathcal{N}(x)$ be the set of all open neighbourhoods of $x \in (X, \mathcal{T})$. Let

$$\mathcal{F}(x) = \{\overline{\phi(S \cap N)} : N \in \mathcal{N}(x)\} \quad (1)$$

Each member of $\mathcal{F}(x)$ is obviously a closed subset of (K, \mathcal{T}_2) .

We shall verify that $\mathcal{F}(x)$ has the finite intersection property, for each $x \in X$. Let $N_1, N_2, \dots, N_n \in \mathcal{N}(x)$. Then

$$\overline{\phi(S \cap N_1)} \cap \overline{\phi(S \cap N_2)} \cap \dots \cap \overline{\phi(S \cap N_n)} \supseteq \overline{\phi(S \cap N_1 \cap N_2 \cap \dots \cap N_n)} \quad (2)$$

As S is dense in (X, \mathcal{T}) , it intersects the open set $N_1 \cap N_2 \cap \dots \cap N_n$ non-trivially. So $S \cap N_1 \cap N_2 \cap \dots \cap N_n \neq \emptyset$ which implies $\overline{\phi(S \cap N_1 \cap N_2 \cap \dots \cap N_n)} \neq \emptyset$. Thus $\mathcal{F}(x)$ has the finite intersection property. As (K, \mathcal{T}_2) is compact, [Proposition 10.3.2](#) implies that $\bigcap_{F_i \in \mathcal{F}(x)} F_i \neq \emptyset$, for each $x \in X$. Define

$$\Phi(x) = \bigcap_{F_i \in \mathcal{F}(x)} F_i, \text{ for each } x \in X. \quad (3)$$

We need to verify that for each $x \in X$, $\Phi(x)$ is a single point, and that $\Phi : (X, \mathcal{T}) \rightarrow (K, \mathcal{T}_2)$ is continuous. If $\Phi(x)$ is a single point, then, by the previous paragraph, $\Phi(x) = \phi(x)$, for all $x \in S$.

Suppose that $y_1, y_2 \in \Phi(x)$, for some $x \in X$ with $y_1 \neq y_2$.

As (K, \mathcal{T}_2) is compact Hausdorff, by [Remark 10.3.28](#) it is regular and Hausdorff and so there exist open neighbourhoods U_1, U_2 of y_1, y_2 , respectively such that $\overline{U_1} \cap \overline{U_2} = \emptyset$. By our assumption, $\overline{\phi^{-1}(U_1)} \cap \overline{\phi^{-1}(U_2)} = \emptyset$. Putting $O_1 = X \setminus \overline{\phi^{-1}(U_1)}$ and $O_2 = X \setminus \overline{\phi^{-1}(U_2)}$, we have $X = O_1 \cup O_2$. So $x \in O_j$ for $j = 1$ or $j = 2$. Since $U_j \cap \overline{\phi(S \setminus \phi^{-1}(U_j))} = \emptyset$ and U_j is an open set in (K, \mathcal{T}) , we have $U_j \cap \overline{\phi(S \setminus \phi^{-1}(U_j))} = \emptyset$, which implies that $y_j \notin \overline{\phi(S \setminus \phi^{-1}(U_j))} = \overline{\phi(S \cap O_j)} \in \mathcal{F}(x)$. By (3), then, $y_j \notin \Phi(x)$. This is a contradiction and so our supposition was false, and $\Phi(x)$ is a single point for each $x \in X$.

Our final task is to show that $\Phi : (X, \mathcal{T}) \rightarrow (K, \mathcal{T}_2)$ is continuous. Let U be an open neighbourhood of $\Phi(x)$ in (K, \mathcal{T}_2) . By (1) and (3),

$$\{\Phi(x)\} = \bigcap_{N \in \mathcal{N}(x)} \overline{\phi(S \cap N)} \subseteq U \quad (4).$$

This implies that $\bigcup_{N \in \mathcal{N}(x)} (K \setminus \overline{\phi(S \cap N)}) \supseteq K \setminus U$. As $K \setminus U$ is compact and each

$K \setminus \overline{\phi(S \cap N)}$ is open, there exist $N_1, N_2, \dots, N_k \in \mathcal{N}(x)$ such that

$$(K \setminus \overline{\phi(S \cap N_1)}) \cup (K \setminus \overline{\phi(S \cap N_2)}) \cup \dots \cup (K \setminus \overline{\phi(S \cap N_k)}) \supseteq K \setminus U.$$

So

$$\bigcap_{i=1}^k \overline{\phi(S \cap N_i)} \subseteq U \quad (5).$$

As $\bigcap_{i=1}^k N_i = N \in \mathcal{N}(x)$, (1), (2), (4) and (5) imply that $\Phi(z) \in \overline{\phi(S \cap N)} \subseteq U$, for every $z \in N$; that is, $\Phi(N) \subseteq U$. So Φ is indeed continuous. \square

Exercises 10.3

Lindelöf Spaces

1. A topological space (X, \mathcal{T}) is said to be a **Lindelöf space** if every open covering of X has a countable subcovering. Prove the following statements.
 - (i) **Every regular Lindelöf space is normal.**
[Hint: use a method like that in [Lemma 10.3.30](#). Note that we saw in [Exercises 9.4 #8](#) that every second countable space is Lindelöf.]
 - (ii) The Sorgenfrey line $(\mathbb{R}, \mathcal{T}_1)$ is a Lindelöf space.
 - (iii) If (X, \mathcal{T}) is a topological space which has a closed uncountable discrete subspace, then (X, \mathcal{T}) is not a Lindelöf space.
 - (iv) It follows from (iii) above and [Exercises 8.1 #12](#) that the product space $(\mathbb{R}, \mathcal{T}_1) \times (\mathbb{R}, \mathcal{T}_1)$ is not a Lindelöf space.
[Now we know from (ii) and (iv) that **a product of two Lindelöf spaces is not necessarily a Lindelöf space.**]
 - (v) Verify that a topological space is compact if and only if it is a countably compact Lindelöf space. (See [Exercises 7.2 #17](#).)
2. Prove that **any product of regular spaces is a regular space.**
3. Verify that **any closed subspace of a normal space is a normal space.**
4. If (X, \mathcal{T}) is an infinite connected Tychonoff space, prove that X is uncountable.

k_ω -spaces

5. A Hausdorff space (X, \mathcal{T}) is said to be a **k_ω -space** if there is a countable collection $X_n, n \in \mathbb{N}$ of compact subsets of X , such that
- (a) $X_n \subseteq X_{n+1}$, for all n ,
 - (b) $X = \bigcup_{n=1}^{\infty} X_n$,
 - (c) any subset A of X is closed if and only if $A \cap X_n$ is compact for each $n \in \mathbb{N}$.

Prove that

- (i) **every compact Hausdorff space is a k_ω -space;**
- (ii) every countable discrete space is a k_ω -space;
- (iii) \mathbb{R} and \mathbb{R}^2 are k_ω -spaces;
- (iv) **every k_ω -space is a normal space;**
- (v) every metrizable k_ω -space is separable;
- (vi) every metrizable k_ω -space can be embedded in the Hilbert cube;
- (vii) **every closed subspace of a k_ω -space is a k_ω -space;**
- (viii) if (X, \mathcal{T}) and (Y, \mathcal{T}') are k_ω -spaces then $(X, \mathcal{T}) \times (Y, \mathcal{T}')$ is a k_ω -space.
- (ix) if S is an infinite subset of the k_ω -space (X, \mathcal{T}) , such that S is not contained in any $X_n, n \in \mathbb{N}$, then S has an infinite discrete closed subspace;
- (x) if K is a compact subspace of the k_ω -space (X, \mathcal{T}) , then $K \subseteq X_n$, for some $n \in \mathbb{N}$.
- (xi)* a topological space (X, \mathcal{T}) is said to be **σ -metrizable** if $X = \bigcup_{n=1}^{\infty} X_n$, where $X_n \subseteq X_{n+1}$ for each $n \in \mathbb{N}$, and each X_n with its induced topology is a closed metrizable subspace of (X, \mathcal{T}) . If every convergent sequence in the σ -metrizable space (X, \mathcal{T}) is contained in X_n , for some $n \in \mathbb{N}$, then (X, \mathcal{T}) is said to be **strongly σ -metrizable**.
 - (α) **every closed subspace of a σ -metrizable space is σ -metrizable;**
 - (β) **every closed subspace of a strongly σ -metrizable space is a strongly σ -metrizable space;**
 - (γ) If (X, \mathcal{T}) is strongly σ -metrizable, then every closed compact subspace K of (X, \mathcal{T}) is contained in X_n , for some $n \in \mathbb{N}$.⁴

6. Prove that **every $T_{3\frac{1}{2}}$ -space is a T_3 -space.**

7. Prove that **for metrizable spaces the conditions (i) Lindelöf space, (ii) separable, and (iii) second countable, are equivalent.**

⁴This result is in fact true without the assumption that K is a closed subspace, see Banach [27].

First Axiom of Countability

8. A topological space (X, \mathcal{T}) is said to satisfy the **first axiom of countability** (or to be **first countable**) if for each $x \in X$, there exists a countable family $U_i, i \in \mathbb{N}$ of open sets containing x , such that if $V \in \mathcal{T}$ and $x \in V$, then $V \supseteq U_{n'}$ for some n .
- (i) Prove that **every metrizable space is first countable**.
 - (ii) Verify that **every second countable space is first countable**, but that the converse is false. [Hint: Consider discrete spaces.]
 - (iii) If $\{(X_i, \mathcal{T}_i) : i \in \mathbb{N}\}$, is a countable family of first countable spaces, prove that $\prod_{i=1}^{\infty} (X_i, \mathcal{T}_i)$ is first countable.
 - (iv) Verify that **every subspace of a first countable space is first countable**.
 - (v) Let X be any uncountable set. Prove that the cube I^X is not first countable, and hence is not metrizable.
[Note that I^X is an example of a [compact Hausdorff and hence] normal space which is not metrizable.]
 - (vi) Generalize (v) above to show that if J is any uncountable set and each (X_j, \mathcal{T}_j) is a topological space with more than one point, then $\prod_{j \in J} (X_j, \mathcal{T}_j)$ is not metrizable.
9. Prove that **the class of all Tychonoff spaces is the smallest class of topological spaces that contains $[0, 1]$ and is closed under the formation of subspaces and cartesian products**.
10. Prove that **any subspace of a completely regular space is a completely regular space**.
11. Using [Proposition 8.6.8](#), prove that if (G, \mathcal{T}) is a topological group, then (G, \mathcal{T}) is a regular space.
[It is indeed true that every topological group is a completely regular space, but this is much harder to prove.]

12. Prove that **if $\{(X_i, \mathcal{T}_i) : i \in I\}$ is any set of connected spaces, then $\prod_{j \in I} (X_j, \mathcal{T}_j)$ is connected.**

[Hint: Let $x = \prod_{i \in I} x_i \in \prod_{i \in I} X_i$. Let S consists of the set of all points in $\prod_{i \in I} X_i$ which differ from $x = \prod_{i \in I} x_i$ in at most a finite number of coordinates. Prove that $C_X(x) \supseteq S$. Then show that S is dense in $\prod_{i \in I} (X_i, \mathcal{T}_i)$. Finally use the fact that $C_X(x)$ is a closed set.]

13. Let $\{(X_j, \mathcal{T}_j) : j \in J\}$ be any set of topological spaces. Prove that **$\prod_{j \in J} (X_j, \mathcal{T}_j)$ is locally connected if and only if each (X_j, \mathcal{T}_j) is locally connected and all but a finite number of (X_j, \mathcal{T}_j) are also connected.**

14. Let $(\mathbb{R}, \mathcal{T}_1)$ be the Sorgenfrey line. Prove the following statements.

- (i) $(\mathbb{R}, \mathcal{T}_1)$ is a normal space.
- (ii) If (X, \mathcal{T}) is a separable Hausdorff space, then there are at most \mathfrak{c} distinct continuous functions $f : (X, \mathcal{T}) \rightarrow [0, 1]$.
- (iii) If (X, \mathcal{T}) is a normal space which has an uncountable closed discrete subspace, then there are at least $2^{\mathfrak{c}}$ distinct continuous functions $f : (X, \mathcal{T}) \rightarrow [0, 1]$. [Hint: Use Urysohn's Lemma.]
- (iv) Deduce from (ii) and (iii) above and [Exercises 8.1 #12](#), that $(\mathbb{R}, \mathcal{T}_1) \times (\mathbb{R}, \mathcal{T}_1)$ is not a normal space.

[We now know that **the product of two normal spaces is not necessarily a normal space.**]

- (v) A topological space (X, \mathcal{T}) is said to be **hereditarily separable** if (X, \mathcal{T}) and each of its subspaces are separable. Show that the Sorgenfrey line $(\mathbb{R}, \mathcal{T}_1)$ is hereditarily separable.

- (vi) Show that if $(\mathbb{R}, \mathcal{T}_1)$ is the Sorgenfrey line, then the product space $(\mathbb{R}, \mathcal{T}_1) \times (\mathbb{R}, \mathcal{T}_1)$, known as the **Sorgenfrey plane** is separable but not hereditarily separable. [So we see that **the product of two heritarily separable spaces need not be hereditarily separable** and that **a subspace of a separable space need not be separable.**

[Hint: Show that the subspace $\{(x, -x) : x \in \mathbb{R}\}$ of the Sorgenfrey plane is an uncountable discrete space.]

15. If S is a set of infinite cardinality m , verify that the cardinality of the set of all finite subsets of S is also m .
16. Verify (1') in the proof of [Proposition 10.3.43](#).
17. Prove [Lemma 10.3.45](#).
18. Prove that every closed interval (Y, \mathcal{T}) of \mathbb{R} is a retract of \mathbb{R} .
19. Let (Y, \mathcal{T}_1) be a subspace of a topological space (X, \mathcal{T}) . Prove that (Y, \mathcal{T}_1) is a retract of (X, \mathcal{T}) if and only for every topological space (Z, \mathcal{T}_2) and every continuous map $\phi : (Y, \mathcal{T}_1) \rightarrow (Z, \mathcal{T}_2)$ can be extended to a continuous map $\Phi : (X, \mathcal{T}) \rightarrow (Z, \mathcal{T}_2)$.
20. Verify the statement in [Remark 10.3.52](#).

***k*-spaces**

21. A topological space (X, \mathcal{T}) is said to be a ***k*-space** (or a **compactly-generated space**) if for each subset S of (X, \mathcal{T}) and each compact subspace (K, \mathcal{T}_1) of (X, \mathcal{T}) , S is closed in (X, \mathcal{T}) if and only if $S \cap K$ is closed in (K, \mathcal{T}_1) .
- (i) Prove that a subset U of a *k*-space is open in (X, \mathcal{T}) if and only if $U \cap K$ is an open subset of (K, \mathcal{T}_1) .
 - (ii) Prove that every compact Hausdorff space, every metrizable space, every k_ω -space, and every Hausdorff sequential space is a *k*-space.
 - (iii) Is a closed subspace of a *k*-space necessarily a *k*-space?
 - (iv) Is an open subspace of a *k*-space necessarily a *k*-space?

 σ -compact Spaces

22. A topological space (X, \mathcal{T}) is said to be **σ -compact** if there exist compact subsets K_n , $n \in \mathbb{N}$, of X such that $X = \bigcup_{n \in \mathbb{N}} K_n$. Prove the following:
- (i) If X is any countable set, then for any topology \mathcal{T} on X , (X, \mathcal{T}) is a σ -compact space.
 - (ii) Every compact space (X, \mathcal{T}) is σ -compact.
 - (iii) For each $n \in \mathbb{N}$, the euclidean space \mathbb{R}^n is σ -compact.
 - (iv) Every k_ω -space is σ -compact. Further, \mathbb{Q} is an example of a σ -compact space which is not a k_ω -space.
 - (v) The topological space \mathbb{I} of all irrational numbers with the euclidean topology is not a σ -compact space. (See [Exercise 5 above](#).)
 - (vi) Every σ -compact space is a Lindelöf space.
 - (vii) Let (X, \mathcal{T}) and (Y, \mathcal{T}_1) be σ -compact spaces. The product space $(X, \mathcal{T}) \times (Y, \mathcal{T}_1)$ is σ -compact. Deduce for this that any finite product of σ -compact spaces is σ -compact.
 - (viii)* Prove that if each of the topological spaces (X_n, \mathcal{T}_n) , $n \in \mathbb{N}$, is homeomorphic to the discrete space \mathbb{Z} , then $\prod_{n \in \mathbb{N}} (X_n, \mathcal{T}_n)$ is not σ -compact and so an infinite product (even a countably infinite product) of σ -compact spaces is not necessarily σ -compact.

Hemicompact Spaces

23. A topological space (X, \mathcal{T}) is said to be **hemicompact** if it has a sequence of compact subsets K_n , $n \in \mathbb{N}$, such that every compact subset C of (X, \mathcal{T}) satisfies $C \subseteq K_n$, for some $n \in \mathbb{N}$. Prove the following:

(i) In the above definition, $X = \bigcup_{n \in \mathbb{N}} K_n$. (Deduce that every hemicompact space is σ -compact.)

[Hint: Use the fact that each singleton set in (X, \mathcal{T}) is compact.]

(ii) \mathbb{R} is hemicompact.

(iii) **Every k_ω -space is hemicompact.** (Deduce that \mathbb{R} is hemicompact.)

(iv) If X is an uncountable set and \mathcal{T} is the discrete topology on X , then (X, \mathcal{T}) is not hemicompact. (Deduce that a metrizable locally compact space is not necessarily hemicompact.)

(v) **A first countable hemicompact space is locally compact.** (Deduce that **a metrizable hemicompact space is locally compact.** Deduce that **every first countable k_ω space is locally compact**)

(vi) **A locally compact Hausdorff σ -compact space is hemicompact.**

(vii) The topological space \mathbb{Q} of all rational numbers with its usual topology is σ -compact but not hemicompact.

(viii) A hemicompact Hausdorff k -space is a k_ω -space.

(ix) If (X, \mathcal{T}) is a hemicompact space and (Y, d) is a metric space, then the space, $C(X, Y)$, of all continuous functions $f : (X, \mathcal{T}) \rightarrow (Y, d)$ with the compact-open topology is metrizable. (See [Definitions A5.6.4\(b\)](#).)

[Hint: Let K_n , $n \in \mathbb{N}$ be compact subsets of X such that each compact set is a subset of some K_n , $n \in \mathbb{N}$. For each $n \in \mathbb{N}$ and each $f, g \in C(X, Y)$ define $d_n(f, g) = \sup_{x \in K_n} d(f(x), g(x))$. Put

$$d(f, g) = \sum_{n=1}^{\infty} \frac{1}{2^n} \frac{d_n(f, g)}{1 + d_n(f, g)}$$

and verify that this is a metric on $C(X, Y)$ and induces the compact-open topology.]

24. Using previous exercises, prove the correctness of the picture below:

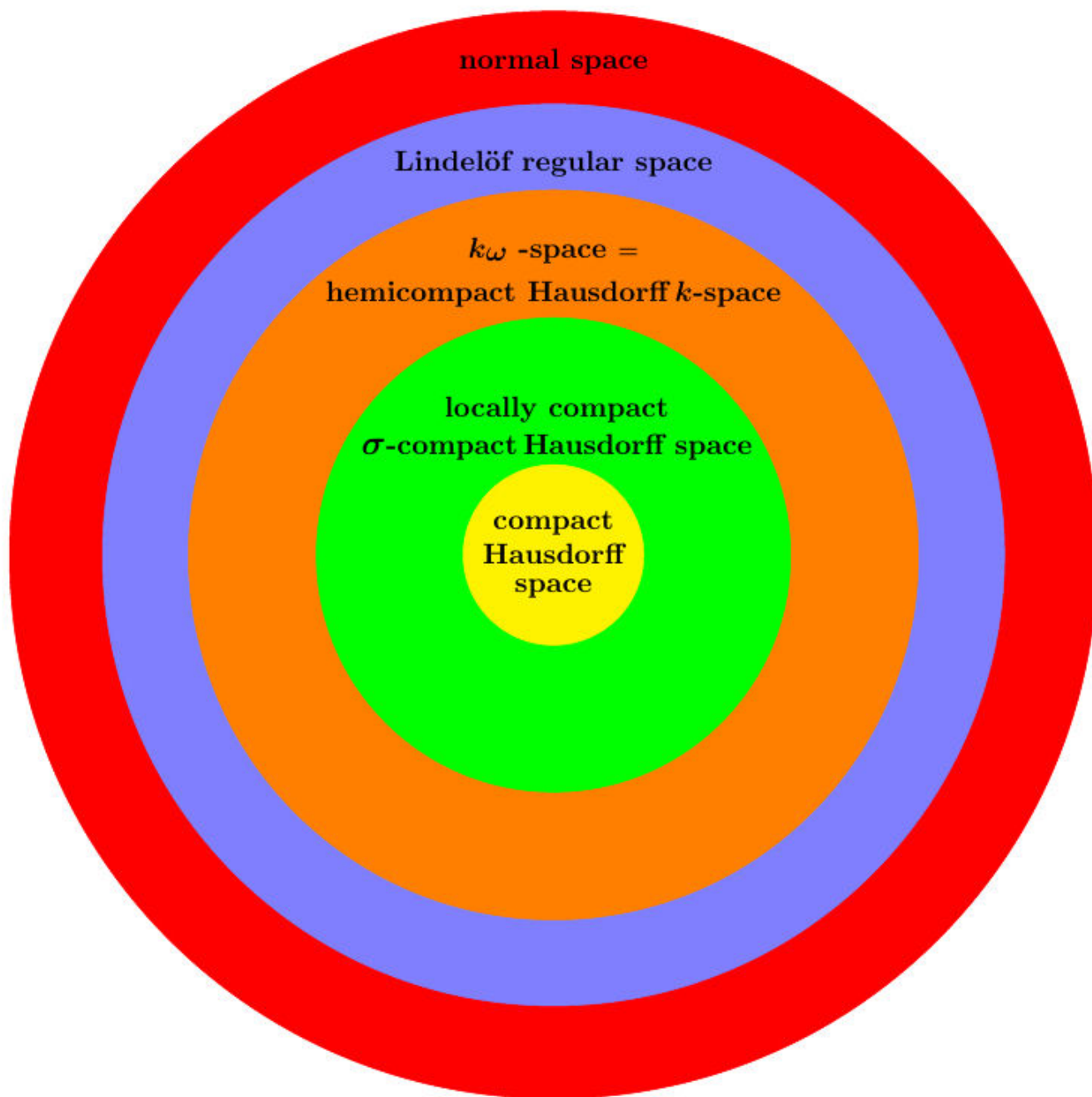

Refinement of a Cover

25. Let X be a set and for some index set I , let $\{A_i : i \in I\}$ be a cover of X ; that is each $A_i \subseteq X$ and $\bigcup_{i \in I} A_i = X$. Then $\{B_j : j \in J\}$, J some index set, is said to be a **refinement** of the cover $\{A_i : i \in I\}$ if $\{B_j : j \in J\}$ is a cover of X and for each $j \in J$, there exists an $i \in I$ such that $B_j \subseteq A_i$.

(i) Prove that every cover $\{A_i : i \in I\}$ of X is also a refinement of itself.

(ii) Prove that every subcover of $\{A_i : i \in I\}$ is a refinement of $\{A_i : i \in I\}$.

26. A set \mathcal{S} of subsets of a topological space (X, \mathcal{T}) is said to be **locally finite** in (X, \mathcal{T}) if each point x in (X, \mathcal{T}) has a neighbourhood N_x such that $N_x \cap \mathcal{S} = \emptyset$, for all but a finite number of $S \in \mathcal{S}$. Prove the following statements:

(i) If the set \mathcal{S} of subsets of any topological space (X, \mathcal{T}) is finite, then \mathcal{S} is locally finite.

(ii) If the set \mathcal{S} is such that every point of X lies in at most one S in \mathcal{S} , then \mathcal{S} is locally finite in (X, \mathcal{T}) for any topology \mathcal{T} on X .

(iii) Let X be an infinite set and \mathcal{T} the finite-closed topology on X . If \mathcal{S} is the set of all open sets in (X, \mathcal{T}) , then \mathcal{S} is not locally finite in (X, \mathcal{T}) .

(iv) Let \mathcal{S} be a locally finite set of subsets of (X, \mathcal{T}) . Define \mathcal{T} to be the set of all closed sets $T = \overline{S}$ for $S \in \mathcal{S}$. Then \mathcal{T} is locally finite.

(v) If \mathcal{S} is an infinite set of subsets of the infinite set X and (X, \mathcal{T}) is a compact space, then \mathcal{S} is not locally finite in (X, \mathcal{T}) .

[Hint: Suppose that (X, \mathcal{T}) is locally finite and for each $x \in X$, choose a neighbourhood U_x which intersects only finitely-many members of \mathcal{S} non-trivially. Then $\{U_x : x \in X\}$ is an open covering of the set X and by the compactness of X , this has a finite subcovering of X . Show this leads to a contradiction.]

(vi) Let \mathcal{S} be an uncountable set of subsets of X . If \mathcal{S} is a cover of the space (X, \mathcal{T}) and (X, \mathcal{T}) is either a Lindelöf space or a second countable space, then \mathcal{S} is not locally finite.

Shrinking Lemma for Normal Spaces

27. For an index set I , let $\{U_i : i \in I\}$ be an open covering of the topological space (X, \mathcal{T}) . The open covering $\{V_i : i \in I\}$ of (X, \mathcal{T}) is said to be a **shrinking** of the cover $\{U_i : i \in I\}$ if $V_i \subseteq \overline{V_i} \subseteq U_i$, for every $i \in I$. Prove the following results leading to the **Shrinking Lemma for Normal Spaces**.

Let (X, \mathcal{T}) be a normal Hausdorff space.

- (i) For each $x \in X$ and every open neighbourhood U of x , there exists an open neighbourhood V of x such that $x \in V \subseteq \overline{V} \subseteq U$.
- (ii) If V is a closed set and U is an open set such that $V \subseteq U$, then there exists an open set W such that $V \subseteq W \subseteq \overline{W} \subseteq U$. (This property characterizes normality.)
- (iii) Let $\{U, V\}$ be an open covering of X . Then there exists an open set W such that $W \subseteq \overline{W} \subseteq U$ and $\{W, V\}$ is an open covering of X .
- (iv) Every finite open covering of (X, \mathcal{T}) has a shrinking; that is, for every open covering $\{U_i : i = 1, 2, \dots, n\}$ of X , there exists an open covering $\{V_i : i = 1, 2, \dots, n\}$ of X , such that $V_i \subseteq \overline{V_i} \subseteq U_i$, for $i = 1, 2, \dots, n$. (This property characterizes normality.)
- (v)* For every locally finite open covering $\{U_i : i \in \mathbb{N}\}$ of X , there exists an open covering $\{V_i : i \in \mathbb{N}\}$ of X , such that $V_i \subseteq \overline{V_i} \subseteq U_i$, for $i \in \mathbb{N}$.
(Without the assumption that the open covering $\{U_i : i \in \mathbb{N}\}$ is locally finite, the Axiom of Choice can be used to prove this result would be false. This is related to Dowker spaces, named after Clifford Hugh Dowker (1912–1982). A **Dowker space** (X, \mathcal{T}) is a normal space for which the product space $(X, \mathcal{T}) \times [0, 1]$ is not a normal space. See Rudin [350].)



Dowker

- (vi)* **(Shrinking Lemma for Normal Spaces)** For I any index set and $\{U_i : i \in I\}$ a locally finite open covering of X , there exists an open covering $\{V_i : i \in I\}$ of X , such that $V_i \subseteq \overline{V_i} \subseteq U_i$, for $i \in I$. (C. H. Dowker proved that if (X, \mathcal{T}) satisfies the Shrinking Lemma for every open covering, rather than every locally finite open covering, then it is a paracompact space - a property introduced in [Exercise 29 below](#).)

[Hint: For the infinite case you may use the Axiom of Choice in the form of the Well-Ordering Theorem, Transfinite Induction and/or Zorn's Lemma.]

Partitions of Unity and Bernstein Polynomials

28. Let (X, \mathcal{T}) be a topological space. A set $\{f_i : i \in I\}$ of continuous functions from (X, \mathcal{T}) to the closed unit interval $[0, 1]$, for some index set I , is said to be a **partition of unity** if for every $x \in X$:

- (a) there is a neighbourhood N_x of x , such that for all but a finite number of $i \in I$, f_i vanishes on N_x , that is $f_i(y) = 0$, for all $y \in N_x$; and
 (b) $\sum_{i \in I} f_i(x) = 1$.

A partition of unity is said to be **subordinate** to a covering \mathcal{U} , of X if each f_i , $i \in I$, vanishes outside some $U \in \mathcal{U}$.

- (i) Verify that for each locally finite open cover $\mathcal{U} = \{U_i : i \in I\}$, for an index set I , of a normal Hausdorff space, there is a partition of unity which is subordinate to \mathcal{U} .

[Hint: Using [Exercise 27 \(vi\) above](#), deduce that there is an open covering $\mathcal{V} = \{V_i : i \in I\}$ of (X, \mathcal{T}) such that each $\overline{V_i} \subseteq U_i$. Then using [Urysohn's Lemma 10.3.22](#), construct continuous functions $g_i : (X, \mathcal{T}) \rightarrow [0, 1]$, $i \in I$, such that $g_i(\overline{V_i}) = \{1\}$, $g_i(X \setminus U_i) = \{0\}$. Finally define

$$f_i = \frac{g_i}{\sum_{i \in I} g_i}, \quad \text{for each } i \in I.$$

Verify that the f_i are properly defined and have the required properties.]

- (ii) [**Bernstein (Basis) Polynomials**⁵] The **Bernstein (basis) polynomials of degree $n \in \mathbb{N}$** are defined to be $B_{i,n}(x) = \binom{n}{i} x^i (1-x)^{n-i}$, for $i = 0, 1, \dots, n$, $B_{i,n} = 0$, for $i < 0$ or $i > n$. Calculate the Bernstein basis polynomials of degree 1, 2, and 3. (There are two of degree 1, three of degree 2, and four of degree 3.)
- (iii) Verify that each Bernstein basis polynomial of degree n can be written in terms of Bernstein basis polynomials of degree $n - 1$; more explicitly,

$$B_{i,n}(x) = (1-x)B_{i,n-1}(x) + xB_{i-1,n-1}(x).$$

- (iv) Using (iii) above, prove by mathematical induction that all Bernstein basis polynomials satisfy $B_{i,n}(x) \geq 0$ when $x \in [0, 1]$ and $B_{i,n}(x) > 0$ when $x \in (0, 1)$.

⁵For a discussion of Bernstein polynomials in the context of the Weierstrass Approximation Theorem, see [Remark A7.1.6](#).

(v) Verify that

$$\sum_{i=0}^k B_{i,k}(x) = \sum_{i=0}^{k-1} B_{i,k-1}(x), \text{ where } k \in \mathbb{N}.$$

(vi) Verify that **the $n + 1$ Bernstein basis polynomials of degree n are a partition of unity** by using (v) to show that

$$\sum_{i=0}^n B_{i,n}(x) = \sum_{i=0}^{n-1} B_{i,n-1}(x) = \sum_{i=0}^{n-2} B_{i,n-2}(x) = \cdots = \sum_{i=0}^1 B_{i,1}(x) = (1-x) + x = 1.$$

(vii) Noting that every polynomial can be written as a linear sum of $\{1, x, x^2, \dots, x^n\}$, prove that **every polynomial of degree n can also be written as a linear sum of Bernstein basis polynomials of degree $1, 2, \dots, n$.**

[Hint: Using mathematical induction, verify that

$$x^k = \sum_{i=k-1}^{n-1} \frac{\binom{i}{k}}{\binom{n}{k}} B_{i,n}(x).]$$

(viii) Verify that **the Bernstein basis polynomials, $B_{0,n}(x), B_{1,n}(x), \dots, B_{n,n}(x)$ are linearly independent** by showing that

$$0 = \lambda_0 B_{0,n}(x) + \lambda_1 B_{1,n}(x) + \cdots + \lambda_n B_{n,n}(x) = 0, \text{ for all } x, \implies \lambda_i = 0, \text{ for } i = 1, 2, \dots, n.$$

(ix) Some writers on this topic (foolishly) define a **Bernstein polynomial** $B_n(x)$ to be any linear combination $\sum_{m=0}^n a_m \binom{n}{m} x^m (1-x)^{n-m}$ of Bernstein basis polynomials of degrees $1, 2, \dots, n$, where $a_1, a_2, \dots, a_n \in \mathbb{R}$. Using (vii) above, verify that **with this definition every polynomial is a Bernstein polynomial.**

Paracompactness

29. A topological space (X, \mathcal{T}) is said to be **paracompact**⁶ if every open cover has an open refinement that is locally finite⁷. Prove the following statements:

(i) **Every compact space is paracompact.**

(ii) **Every closed subspace of a paracompact space is paracompact.**

⁶Some authors include Hausdorffness in the definition of paracompact.

⁷Paracompact spaces were introduced into the literature by Jean Alexandre Eugène Dieudonné who also proved that every Hausdorff paracompact space is a normal space.

- (iii)** **Every F_σ -set S in a regular paracompact space is paracompact.**
- (iv) **Every regular Lindelöf space is paracompact.**
- (v) \mathbb{R}^n is paracompact, for every $n \in \mathbb{N}$.
- (vi) The Sorgenfrey line is paracompact.
- (vii) Let (X, \mathcal{T}) be the product of uncountable many copies of \mathbb{Z} . Prove that (X, \mathcal{T}) is not paracompact.
- (viii) Deduce from (vii) above, that if (X, \mathcal{T}) is the product of uncountable many copies of any infinite discrete space, then (X, \mathcal{T}) is not paracompact.
- (ix) Deduce from (viii) above, that if (X, \mathcal{T}) is the product of uncountable many copies of \mathbb{R} , then (X, \mathcal{T}) is not paracompact.
- (x) Would (ix) above remain true, if \mathbb{R} were replaced by an arbitrary infinite non-compact metrizable space?
- (xi) **Every Hausdorff Lindelöf space is paracompact.**
- (xii)* **Every Hausdorff paracompact space is a regular space.**
- (xiii)* Every Hausdorff paracompact space is a T_4 -space; that is a Hausdorff normal space.
- (xiv) **The space (X, \mathcal{T}) is a paracompact Hausdorff space if and only if for every open cover \mathcal{U} of (X, \mathcal{T}) , then there is a partition of unity subordinate to \mathcal{U} .** [Hint: Use (xiii) above and Exercises 10.3 #28(i).]
- (xv)* **Every metrizable space is paracompact.**
- (xvi) **If (X, \mathcal{T}) is paracompact Hausdorff space and (Y, \mathcal{T}_1) is a compact Hausdorff space, then the product space $(X, \mathcal{T}) \times (Y, \mathcal{T}_1)$ is paracompact Hausdorff;**
- (xvii) If $f : (X, \mathcal{T}) \rightarrow (Y, \mathcal{T}_1)$ is a continuous closed surjective map of the paracompact Hausdorff space (X, \mathcal{T}) onto the Hausdorff space (Y, \mathcal{T}_1) , then (Y, \mathcal{T}_1) is paracompact. [Hint: Use (xii) above.]
- (xviii) **Every countably compact paracompact space is compact.**
- (xix) A topological space (X, \mathcal{T}) is said to be **metacompact** if for any open cover $\{A_i : i \in I\}$ of (X, \mathcal{T}) , there is a refinement $\{B_j : j \in J\}$ which is also an open cover of (X, \mathcal{T}) with the property that every point $x \in X$ is contained in only finitely many sets B_j , $j \in J$. Prove that **every paracompact space is metacompact** and **the product of a metacompact Hausdorff space and a compact Hausdorff space is metacompact.**

30. Using previous exercises, prove the correctness of the picture below:

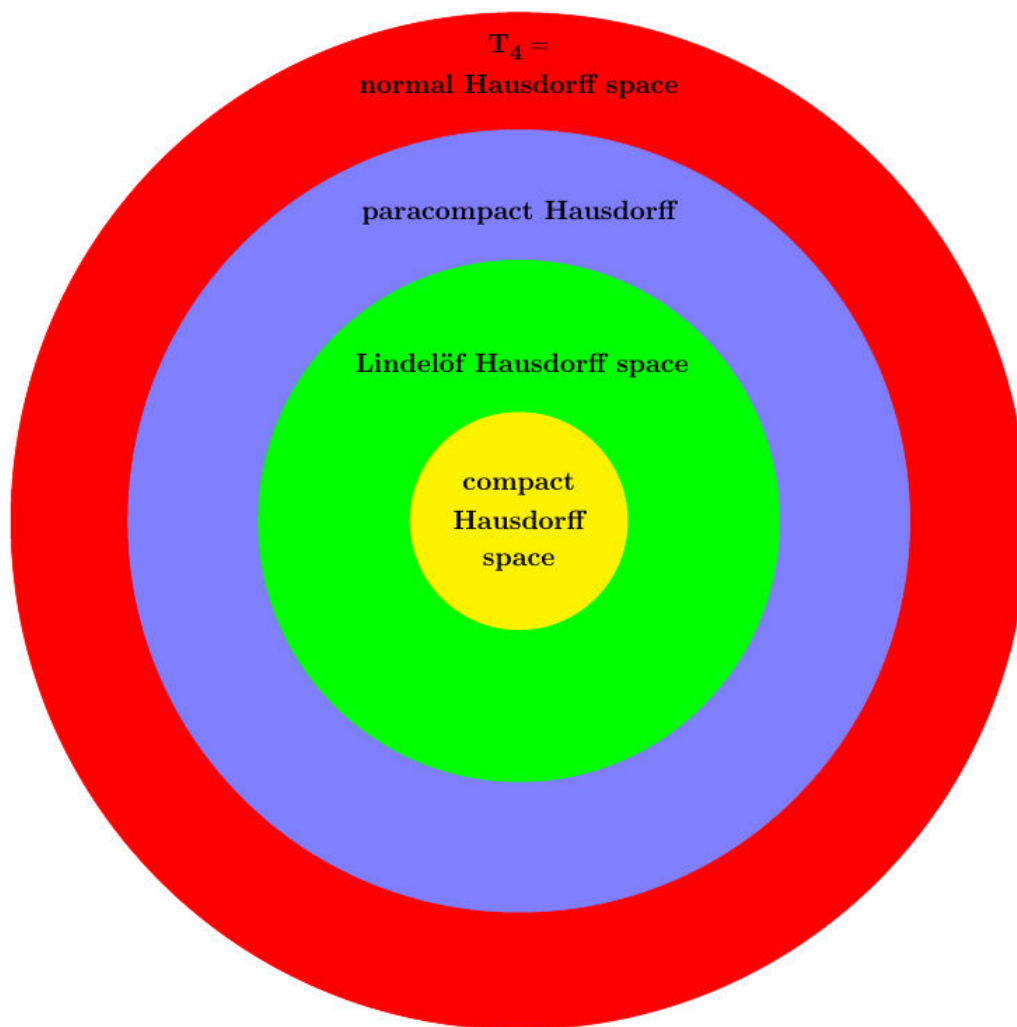

Cellularity

31. Let (X, \mathcal{T}) be a topological space, the **cellularity** of the topological space (X, \mathcal{T}) is the cardinal number ⁸ $c(X)$ given by

$$c(X) = \aleph_0 + \sup\{\text{card } \mathcal{U} : \mathcal{U} \text{ is a set of pairwise disjoint open sets in } (X, \mathcal{T}).\}$$

The **density** of (X, \mathcal{T}) is the cardinal number $d(X)$ given by

$$d(X) = \aleph_0 + \min\{\text{card } S : S \subseteq X \text{ and } S \text{ is dense in } X\}.$$

The **spread** of (X, \mathcal{T}) is the cardinal number $s(X)$ given by

$$s(X) = \aleph_0 + \sup\{\text{card } (D) : D \text{ is a discrete subspace of } X\}.$$

The **Lindelöf degree**, $L(X)$, of (X, \mathcal{T}) is the smallest infinite cardinal number \aleph such that every open cover of X has a subcover of cardinality $\leq \aleph$. Of course $L(X) = \aleph_0$ if and only if (X, \mathcal{T}) is a Lindelöf space.

Write down and verify the obvious relations between cellularity, density, spread, Lindelöf degree, and weight of any topological space (X, \mathcal{T}) .

\mathfrak{C} -bases

32. Recall⁹ the definition of poset in [Definition 10.2.1](#). A subset A of the poset P is said to be **cofinal** in P if for each $x \in P$, there exists an $a \in A$ such that $x \leq a$.

A subset A of the poset P is said to be **coinital** in P if for each $x \in P$, there exists a $b \in A$ such that $b \leq x$.

A subset A of P is said to be **bounded** if there exists an $x \in P$ such that for all $a \in A$, $a \leq x$.

A poset P is said to be **lower complete** if for every subset A of X has a greatest lower bound.

The **cofinality of a poset P** , denoted by $\text{cf}(P)$ is the least of the cardinalities of the cofinal subsets of P .

⁸There are numerous **cardinal invariants** (**cardinal functions**) associated with each topological space. We have introduced only 4 of these in this exercise. For more detailed discussion, see Juhász [222] and Chapter 1 of Kunen and Vaughan [248].

⁹This exercise is inspired by the beautiful manuscript, Banach [28]. Most of the material here appears in that manuscript of Taras Banach (1968–).

Let P and Q be posets. The poset Q is said to be **Tukey dominated** by P , denoted by $Q \leq_T P$, if there exists a function $f : P \rightarrow Q$ that maps every cofinal subset of P to a cofinal subset of Q . The posets P and Q are said to be **Tukey equivalent** if $P \leq_T Q$ and $Q \leq_T P$.

If (X, \mathcal{T}) is a topological space, for each point $x \in X$ the set N_x of all neighbourhoods in (X, \mathcal{T}) of x is a poset if we give it the partial order of reverse inclusion; that is, if $N_1, N_2 \in N_x$ then $N_2 \leq N_1$ precisely when $N_1 \subseteq N_2$. So N_x is a directed lower complete poset. (A poset P is said to be **directed** if for every $a, b \in P$, there exists a $c \in P$ such that $a \leq c$ and $b \leq c$.) For $x \in X$, the poset N_x is Tukey dominated by ω if and only if the topological space (X, \mathcal{T}) is first countable at the point x .

Let P be a poset. The topological space (X, \mathcal{T}) is said to have a **neighbourhood P -base** at the point $x \in X$ if the poset N_x of all neighbourhoods of x is Tukey dominated by P . Since N_x is lower complete, this happens if and only if at each $x \in X$, the space (X, \mathcal{T}) has a neighbourhood base $\{U_\alpha[x] : \alpha \in P\}$ such that $U_\beta[x] \subseteq U_\alpha[x]$ for all $\alpha \leq \beta \in P$. If a topological space (X, \mathcal{T}) has a neighbourhood P -base $\{U_\alpha : \alpha \in P\}$ at each $x \in X$, then these neighbourhood bases can be encoded by the set $\{U_\alpha : \alpha \in P\}$ of the entourages $U_\alpha = \{(x, y) \in X \times X : y \in U_\alpha[x]\}$, $\alpha \in P$. Such a family $\{U_\alpha : \alpha \in P\}$ is said to be a **P -based topological space**. A topological space (X, \mathcal{T}) has a neighbourhood P -base at each point if and only if it has a P -base.

Banach [28], Banach and Leiderman [29], Gabrielyan and Kąkol [144], Leiderman et al. [257], and Gabrielyan et al. [145] study topological spaces, topological groups and topological vector spaces with an **ω^ω -base**. (Note that by ω^ω we mean the uncountable cardinal number of the set $\mathbb{N}^{\mathbb{N}}$ with co-ordinatewise partial ordering \leq , given by $f \leq g$ when $f(n) \leq g(n)$, for $f, g : \mathbb{N} \rightarrow \mathbb{N}$ and $n \in \mathbb{N}$, not the countable ordinal number.) In some literature these are known as topological spaces with a **\mathfrak{G} -base**.

- (i) Let P and Q be posets and $f : P \rightarrow Q$. Verify that Q is Tukey dominated by P if and only if $f^{-1}(B)$ is bounded in P for every bounded subset B of Q .
- (ii) Verify that a poset is Tukey dominated by ω if and only if P is a directed poset of countable cofinality.

- (iii) Let P and Q be posets. If Q has a greatest element, verify that P is Tukey dominated by Q .
- (iv) Let P and Q be posets. If both P and Q have greatest elements, the P and Q are Tukey equivalent.
- (v) Verify that a topological space (X, \mathcal{T}) is first countable if and only if it has an ω -base.
- (vi) Verify that every topological space with an ω -base has an ω^ω -base. Deduce that every metrizable space has an ω^ω -base.

Banach spaces, Dual Spaces, Weak Topologies, and Reflexivity

33. Let N be a normed vector space over K , which is the field \mathbb{R} of real numbers or \mathbb{C} of complex numbers, with norm $\| \cdot \|$. A linear map from the underlying vector space of N into K is said to be a **linear functional**. Denote the set of all continuous linear functionals from N into K by N^* . If $\phi, \phi_1, \phi_2 \in N^*$ and $\lambda \in K$, define $(\phi_1 + \phi_2)(x) = \phi_1(x) + \phi_2(x)$ and $(\lambda\phi)(x) = \lambda(\phi(x))$. With these operations N^* is a vector space over K . Define a norm $\| \cdot \|_{\text{op}}$ on N^* by $\| \phi \|_{\text{op}} = \sup\{|\phi(x)| : x \in N, \|x\| \leq 1\}$, for $\phi \in N^*$. (op is short for operator.)
- (i) Verify that N^* , with $\| \cdot \|_{\text{op}}$, is indeed a normed vector space. (The normed vector space N^* is called the **dual space** of N .)
 - (ii) Verify that with this norm, N^* is in fact a Banach space.
 [Hint: Let ϕ_n be a Cauchy sequence of members of N^* . For each $x \in N$, consider the sequence $\phi_n(x)$ in the field K of scalars. Use the fact that K is a complete metric space.]
- (iii)** Verify each of the following:
- (a) if N is \mathbb{R}^n , $n \in \mathbb{N}$, then N^* is isometrically isomorphic to \mathbb{R}^n ;
 - (b) if N is ℓ_p for $1 < p < \infty$, then N^* is isometrically isomorphic to ℓ_q , where $\frac{1}{p} + \frac{1}{q} = 1$;
 - (c) if N is ℓ_2 , then N^* is isometrically isomorphic to ℓ_2 ;
 - (d) if N is c_0 , then N^* is isometrically isomorphic to ℓ_1 ;
 - (e) if N is ℓ_1 , then N^* is isometrically isomorphic to ℓ_∞ .

- (iv) Consider the **double dual** N^{**} of N ; that is, $N^{**} = (N^*)^*$. Verify that the natural map $\Gamma : N \rightarrow N^{**}$ given by $\Gamma(x)(\phi) = \phi(x)$, for $x \in N$, $\phi \in N^*$ is one-to-one, linear and norm preserving; that is, $\|\Gamma(x)\|_{op} = \|x\|$, for all $x \in N$. Deduce that if N is a Banach space, then the Banach spaces N and $\Gamma(N)$ are isomorphic as Banach spaces; that is, the map $\Gamma : N \rightarrow \Gamma(N) \subseteq N^{**}$ is one-to-one and onto and an isometric isomorphism of N onto $\Gamma(N)$.
- (v) A normed vector space is said to be **reflexive** if in the notation above, $\Gamma(N) = N^{**}$. Deduce that if N is reflexive, then it is a Banach space and N and N^{**} are isometric Banach spaces.
- (vi) Let N be a normed vector space over the scalar field K which is \mathbb{R} or \mathbb{C} , as usual. Then the norm on N induces a topology on N which is called the **strong topology**. Let N^* be the dual space of N , which we have seen is a Banach space. Obviously the strong topology is such that, by definition, every $\phi : N \rightarrow K$, where $\phi \in N^*$, is continuous. However, there may be coarser topologies on the vector space N such that all such ϕ are continuous. The coarsest topology \mathcal{T} on the vector space N such that for each $\phi \in N^*$, the linear functional $(N, \mathcal{T}) \rightarrow K$ is continuous is called the **weak topology**. The coarsest topology \mathcal{T}^* on the vector space N^* such that every linear functional $\Gamma(x) : N^* \rightarrow K$, given by $\Gamma(x)(\phi) = \phi(x)$, for each $x \in N$ and $\phi \in N^*$, is called the **weak*-topology**. Verify from the definitions that the weak*-topology on N^* is coarser than the weak topology on N^* but the two topologies coincide if N is a reflexive Banach space.

(vii) **[Banach-Alaoglu Theorem]** (Leonidas Alaoglu (1914–1981) was a Canadian mathematician who extended Banach's result from separable spaces to the general case.) **If N is a normed vector space, then the closed unit ball of N^* is weak*-compact; that is, compact in the weak*-topology on N^* .** (This result should be contrasted with that in [Exercises 8.3 #3 \(vi\)](#).) Prove this theorem by verifying each of the following steps.

- (a) Let $B^* = \{\phi : \phi \in N^*, \|\phi\|_* \leq 1\}$ be the closed unit ball of N^* , where $\|\cdot\|_*$ is the norm on N^* . Then each linear functional $\phi \in B^*$ maps the closed unit ball $B = \{x : x \in N, \|x\| \leq 1\}$ of N into the disc $D = \{c : c \in K, |c| \leq 1\}$.
- (b) So we can identify B^* with a subset of the product space D^B . the space
- (c) We can readily check that the weak*-topology on B^* is in fact the subspace topology from the product topology on D^B .
- (d) Indeed, B^* is a closed subspace of D^B .
- (e) As D is compact, [Tychonoff's Theorem 10.3.4](#) implies that D^B is compact.
- (e) So the closed subspace B^* of D^B is compact; that is, B^* is weak*-compact. □

(viii) Let K be the real number field \mathbb{R} or the complex number field \mathbb{C} and V, W vector spaces over K . A **linear operator** from V to W is a map $\phi : V \rightarrow W$ such that $\phi(\lambda x + \mu y) = \lambda\phi(x) + \mu\phi(y)$, for all $x, y \in V$ and all $\lambda, \mu \in K$. If V and W are normed vector spaces, a linear operator $\phi : V \rightarrow W$ is said to be **bounded** if there exists a positive real number M such that $\|\phi(x)\| \leq M\|x\|$ for every $x \in V$. Prove that **a linear operator $\phi : V \rightarrow W$ is bounded if and only if it is continuous.** The smallest such M is called the **operator norm** and denoted $\|\cdot\|_{\text{op}}$, and the set $B(V, W)$ of all linear operators from V to W with this norm $\|\cdot\|_{\text{op}}$ is a normed vector space. (Observe that the norm $\|\cdot\|_{\text{op}}$ depends on the norms on V and W .) The normed vector space $(B(V, W), \|\cdot\|_{\text{op}})$ is called the **space of bounded linear operators**. Define **bounded linear functional** and deduce from what we just proved that a linear functional $\phi : V \rightarrow K$ is bounded if and only if it is continuous.

(ix) Let $V = C[0, 1]$ the Banach space of all continuous functions $f : [0, 1] \rightarrow \mathbb{R}$ with the norm given by $\|f\| = \left(\int_0^1 |f(x)|^2 dx\right)^{\frac{1}{2}}$. Define a linear functional $\phi : V \rightarrow \mathbb{R}$ by $\phi(f) = f(0)$, for all $f \in C[0, 1]$. Verify (a) V is a normed vector space; (b) V is a Banach space; (c) ϕ is a linear functional; (d) by considering functions $f_n : [0, 1] \rightarrow \mathbb{R}$ such that $f_n(0) = n$ but $\int_0^1 (f_n(x))^2 = 1$, for each positive integer n , that ϕ is not a bounded linear functional.

(x)* **(One-dimensional version of the Hahn-Banach Theorem over \mathbb{R})** The Hahn-Banach Theorem was proved independently in the 1920s by the Austrian mathematician Hans Hahn (1879–1934) and the Polish mathematician Stefan Banach (1892–1945).) Prove the following lemma.

Lemma. Let B be a normed vector space, E a vector subspace of B , and $f : E \rightarrow \mathbb{R}$ a bounded linear functional. Then for any $x \in B \setminus E$, there exists a linear functional $f_1 : E_1 = \text{span}\{E, x\} \rightarrow \mathbb{R}$ that extends f (that is, $f(x) = f_1(x)$, for all $x \in E$) and satisfies $\|f\|_{\text{op}} = \|f_1\|_{\text{op}}$. (If X is a subset of a vector space L , $\text{span}(L)$ denotes the smallest vector subspace of L which contains X .)

[Hint. If $\|f\|_{\text{op}} = 0$, the result is seen trivially to be true. So we can, without loss of generality, assume $\|f\|_{\text{op}} = 1$. Now if $x \in E_1$, then $x = \lambda x_1 + y$, for $\lambda \in \mathbb{R}$ and $y \in E$. To define f_1 as an extension of f it suffices to choose an appropriate value of $f_1(x_1)$ – by appropriate we mean a value such that $\|f\|_{\text{op}} = \|f_1\|_{\text{op}}$. Let us put $f_1(x_1) = a_1$, so that $f_1(\lambda x_1 + y) = \lambda a_1 + f(y)$. It therefore suffices to choose a_1 such that $|f_1(x)| \leq \|x\|$, for all $x \in E_1$; that is,

$$-\|\lambda x_1 + y\| \leq \lambda a_1 + f(y) \leq \|\lambda x_1 + y\|, \text{ for all } \lambda \in \mathbb{R} \text{ and } y \in E.$$

This holds for $\lambda = 0$ by hypothesis on f , so we can assume $\lambda \neq 0$. This allows us to rewrite the above inequality as

$$-\left\|x_1 + \frac{y}{\lambda}\right\| - f\left(\frac{y}{\lambda}\right) \leq a_1 \leq \left\|x_1 + \frac{y}{\lambda}\right\| - f\left(\frac{y}{\lambda}\right), \text{ for all } \lambda \in \mathbb{R} \text{ and } y \in E.$$

$$\text{Equivalently } -\|x_1 + z\| - f(z) \leq a_1 \leq \|x_1 + z\| - f(z), \text{ for all } z \in E.$$

Show that for any $z_1, z_2 \in E$

$$-\|x_1 + z_1\| - f(z_1) \leq \|x_1 + z_2\| - f(z_2).$$

Observe that this implies

$$-\infty < \sup_{z_1 \in E} [-\|x_1 + z_1\| - f(z_1)] \leq \inf_{z_2 \in E} [\|x_1 + z_1\| - f(z_2)] < \infty.$$

So we can choose for a_1 any value between $\sup_{z_1 \in E} [-\|x_1 + z_1\| - f(z_1)]$ and

$$\inf_{z_2 \in E} [\|x_1 + z_1\| - f(z_2)].$$

(xi)* **[Hahn-Banach Theorem]** Let B be a normed vector space over a field K , where K is \mathbb{R} or \mathbb{C} , and E a vector subspace of B . If $f : M \rightarrow K$ is a bounded linear functional, then there exists a bounded linear function $f_1 : B \rightarrow K$ that extends f . Using (x) above and Zorn's Lemma, prove the Hahn-Banach Theorem.

[Hint. For convenience we discuss only the case that $K = \mathbb{R}$. We saw in (x) above how to extend a bounded linear functional from E to a vector space, one dimension greater. We could extend once more to a vector space of dimension 2 greater. Indeed we could do such an extension a finite number of times. But to extend to a space of uncountable dimension greater, it is necessary to use the Axiom of Choice or its equivalent, Zorn's Lemma. Let \mathcal{B} consist of all pairs (N, f_N) such that

- (a) N is a vector subspace of B that contains E ;
- (b) f_N is a bounded linear functional on N ;
- (c) f_N extends f ; that is $f_N(x) = f(x)$ for all $x \in E$;
- (d) $\|f_N\|_{\text{op}} = \|f\|_{\text{op}}$.

Now put a partial order on \mathcal{B} as follows:

$$(N, f_N) \leq (N', f_{N'}) \text{ if } N \subseteq N' \text{ and } f_{N'} \text{ extends } f_N \text{ on } N.$$

Complete the proof by considering a totally ordered subset of \mathcal{B} , observing that it has an upper bound, deducing by Zorn's Lemma that the partial ordering has a maximal element (N_M, f_M) and using (x) to show (N_M, f_M) cannot be a maximal element unless $B_M = B$.]

(xii) Let B be a normed vector space over \mathbb{R} and $0 \neq x_1 \in B$. Using the Hahn-Banach Theorem show that there exists a bounded linear functional $f_1 : B \rightarrow \mathbb{R}$ with $\|f_1\|_{\text{op}} = 1$ and $f_1(x_1) = \|x_1\|$.

[Hint. Let E be the vector subspace of B spanned by x_1 . Define a linear functional f on E by $f(\lambda x_1) = \lambda \|x_1\|$. Show that f is a bounded linear functional and $\|f\|_{\text{op}} = 1$. Then extend f to all of B using the Hahn-Banach Theorem.]

(xiii) Let B be a normed vector space and E a proper closed subspace of B . Then there exists a bounded linear functional $f : B \rightarrow \mathbb{R}$ with $\|f\|_{\text{op}} = 1$ and $f(x) = 0$, for all $x \in E$. (This result generalizes that in (xii) above.)

(xiv) Prove the following statement: **Let E be a normed vector space. If E^* is separable, then E is separable.**

[Hint. Noting that the unit sphere in E^* is separable, let $\{f_n \in E^* : n \in \mathbb{N}\}$ be a countable dense subset of this unit sphere. Verify that for each $n \in \mathbb{N}$, there exists $x_n \in E$ with $\|x_n\| = 1$ such that $|f_n(x_n)| \geq \frac{1}{2}$. Then let W be the closed linear span of $\{x_n : n \in \mathbb{N}\}$. The aim is to show that $W = B$. Suppose to the contrary that W is a proper closed subspace of B . By (xiii) there exists an $f \in B^*$ with $\|f\|_{\text{op}} = 1$ and $f(x) = 0$, for all $x \in W$. So $f(x_n) = 0$, for all $n \in \mathbb{N}$. Show that this implies that for all $n \in \mathbb{N}$

$$\frac{1}{2} \leq |f_n(x_n)| = |f_n(x_n) - f(x_n)| \leq \|f_n - f\|_{\text{op}} \|x_n\| = \|f_n - f\|_{\text{op}}.$$

But this contradicts the assumption that $\{f_n : n \in \mathbb{N}\}$ is dense in the unit sphere of B^* .]

(xv) Let $(N, \| \cdot \|_N)$ be a normed vector space and E a closed vector subspace of N . We define an equivalence relation \sim on N by $x \sim y$ if $x - y \in E$, $x, y \in N$ and define N/E to be the set of all these equivalence classes. We define the map $g : N \rightarrow N/E$ by $g(x)$ is the equivalence class of x . Define $\|z\|_{N/E} = \inf_{x \in N} \{\|x\|_N : g(x) = z\}$. Prove the following:

- (a) Define the natural vector space structure on N/E induced by the vector space structure on N . Verify that N/E is indeed a vector space;
- (b) $\| \cdot \|_{N/E}$ is a norm on the vector space N/E ;
- (c) g is an open continuous linear operator;
- (d) if N is a Banach space, then $(N/E, \| \cdot \|_{N/E})$ is a Banach space.

The normed vector space $(N/E, \| \cdot \|_{N/E})$ is said to be the **quotient space** of N by E .

(See also quotient (topological) space in [Definitions 11.1.1](#) and quotient (topological) group in [Proposition A5.2.16](#).)

(xvi) Let N be a normed vector space, E a subset of N . Then E^\perp is defined to be $\{f \in N^* : f(x) = 0, \text{ for all } x \in E\}$, and is called the **annihilator** of E . Prove that E^\perp is a closed vector subspace of N^* and that $E^\perp = (\overline{\text{span } E})^\perp$. If F is a subset of N^* , then F_\perp is defined to be $\{x \in N : f(x) = 0, \forall f \in F\}$ and is called the **pre-annihilator** of F . Prove also that F_\perp is a closed vector subspace of N and $F_\perp = (\text{span } F)_\perp$.

(xvii)* Prove the following statement: **Let N be a normed vector space and E a vector subspace of N . Then**

(a) E^* is isometrically isomorphic to N^*/E^\perp ;

(b) If E is closed, then $(N/E)^*$ is isometrically isomorphic to E^\perp .

(Note that this result for Banach spaces is the analogue of [Corollary A5.9.6](#) and [Corollary A5.9.7](#) in Pontryagin Duality of topological groups.)

[Hint. (a) Let $\Theta : N^* \rightarrow N^*/E^\perp$ be the natural mapping. Consider $f \in E^*$. By the Hahn-Banach Theorem there exists a bounded linear functional $f_1 : N \rightarrow \mathbb{R}$ such that f_1 is an extension of F and $\|f_1\|_{\text{op}} = \|f\|_{\text{op}}$. Now prove that the map $\phi : E^* \rightarrow N^*/E^\perp$ given by $\phi(f) = \Theta(f_1)$ is an isometry of E^* onto N^*/E^\perp .

(b) Let $\Gamma : N \rightarrow N/E$ be the natural quotient mapping. Define the map $\delta : (N/E)^* \rightarrow E^*$ by $\delta(f) = f \circ \Gamma$. Verify that δ is linear and $\delta(f)(x) = 0$, for all $x \in E$. Deduce from this that δ maps $(N/E)^*$ into E^\perp . Now prove that δ is an isometry of $(N/E)^*$ onto E^\perp .]

(xviii) Prove the following statement: **Let B be any Banach space and let $\Phi : B \rightarrow B^{**}$ be the canonical linear mapping given by $\Phi(x)(\gamma) = \gamma(x)$, for all $\gamma \in B^*$ and $x \in B$. Then Φ maps B isometrically onto the subspace $\Phi(B)$ of B^{**} .**

(xix) Prove the following result: **A Banach space B is reflexive if and only if B^* is reflexive.**

[Hint. Firstly consider the case that B is reflexive. As B is reflexive, the canonical linear operator $\Phi : B \rightarrow B^{**}$ is an isometry. Using (xviii) above, to prove that B^* is reflexive, it suffices to show that the canonical bounded linear operator Ψ from B^* to B^{***} is surjective. Let $\gamma \in B^{***}$. So $\gamma \in (\Phi(B))^*$; that is, γ is a bounded linear functional from $\Phi(B)$ to \mathbb{R} . Let $f_\gamma : B \rightarrow \mathbb{R}$ be defined by $f_\gamma(b) = \gamma(\Phi(b))$, for all $b \in B$. Verify that $f_\gamma \in B^*$ and that $\Psi(f_\gamma) = \gamma$. This shows that Ψ has the required properties. Conversely, suppose that B is not reflexive. Then $\Phi(B)$ is a proper subspace of B^{**} . Use (xiii) above to obtain a contradiction.]

- (xx) Deduce the following theorem using the Banach-Alaoglu Theorem: **The Banach space B is reflexive if and only if its closed unit ball T is weakly compact.**

[Hint. First use the Banach-Alaoglu Theorem to prove that the closed unit ball in a reflexive Banach space B is weakly compact. Observe that if B is a reflexive Banach space, then $B = B^{**}$ and the weak topology on B coincides with the weak*-topology on $(B^*)^* = B$. Deduce that T is weakly compact. Conversely assume that T is weakly compact and let T'' be the closed unit ball in B^{**} . The embedding of B in B^{**} is weak-weak* continuous, so the image of T under this embedding is weak*-compact in B^{**} . Using the fact that the image of T is weak*-dense in T'' , we can see the image of T is in fact T'' . From this it follows that the image of B in B^{**} equals B^{**} , that is B is reflexive.]

- (xxi) A Banach space B is said to be **weakly compactly generated** or **WCG** if it has a subset S which is weakly compact (that is, compact in the weak topology on B) such that the closed linear span of S is B . Prove using Exercises 8.3 #3(vi) that **every separable Banach space is a WCG space** and using (xx) above that **every reflexive Banach space is also a WCG space.**
- (xxii) Let B be a Banach space and E a closed subspace of B . By considering the quotient Banach space B/E , show that for any $x_1 \in B \setminus E$ there exists a bounded linear functional $f_{x_1} : B \rightarrow \mathbb{R}$ such that $f_{x_1}(y) = 0$, for all $y \in E$ but $f_{x_1}(x_1) \neq 0$. Deduce that **if E is a closed vector subspace of the Banach space B , then E is a closed subspace of B with its weak topology.**
- (xxiii)* Using (xx) prove that **every closed subspace of a reflexive Banach space is a reflexive Banach space.**

[Hint. Let B be a reflexive Banach space and E a closed subspace of B . Let T and S be the closed unit balls in B and E , respectively. As B is reflexive, T is weakly compact. Using this and (xxii) above, show that S is weakly compact.]

- (xxiv)** Prove that **a Banach space B is separable if and only if the closed unit ball of B^* is weak*-metrizable.** (This result complements that of Exercises 8.3 #3 (vi).)
- (xxv) In the 1930s the Polish mathematicians Stefan Banach and Stanisław Mazur (1905–1981) stated a question, which has become known as the **Separable Quotient Problem** and is still unanswered. **Does every infinite-dimensional Banach space have a quotient space which is an infinite-dimensional separable Banach space?** This has been proved to be true for a variety of special cases, such as when the infinite-dimensional Banach space B is reflexive. (For other special cases, see Argyros et al. [14].) To verify the reflexivity special case, check that the following statements are true:
- (a) Every infinite-dimensional Banach space has a subspace which is an infinite-dimensional separable Banach space.
 - (b) Every closed subspace of a reflexive Banach space is reflexive.
 - (c) If a Banach space B is such that B^* is separable, then B is separable.
 - (d) If a separable reflexive Banach space B , then B^* is separable.
 - (e) If B is any infinite-dimensional reflexive Banach space, then its dual space B^* has an infinite-dimensional separable reflexive Banach subspace E which implies that B^{**} has an infinite-dimensional separable (reflexive) quotient Banach space E^* .
 - (f) **If B is an infinite-dimensional reflexive Banach space, then B has an infinite-dimensional separable (reflexive) quotient Banach space.**

- (xxvi) A Banach space B is said to an **Asplund space**, named after Edgar Asplund (1931–1974), if every separable closed subspace of B has a separable dual.
- (a) Using (xxv) above, verify that **every reflexive Banach space is an Asplund space.**
- (b) Verify that **every closed subspace on an Asplund space is an Asplund space.**
- (c) Noting that the dual space of the separable Banach space ℓ_1 is the non-separable space ℓ_∞ , we see that **not every separable Banach space is an Asplund space.** Deduce that **not every weakly compactly generated space is an Asplund space.**
- (d) Prove that **a separable Banach space B is an Asplund space if and only if its dual B^* is a separable Banach space.**
- (e) Verify that **every Banach space which is a quotient space of an Asplund space is an Asplund space.**
- (f) Verify that **every finite product of Asplund spaces is an Asplund space.**

Remarks. (α) As a generalization of (f) we mention that **being an Asplund space is a three space property**; that is, if B is a Banach space which has a closed vector subspace E such that E and the quotient Banach space B/E are Asplund spaces, then B is an Asplund space. (See [Exercises A5.12 #5](#) where the three space property was introduced.) This result is Theorem 4.11a of Castillo and González [73].

(β) If B is a Banach space and the dual space B^* is a WCG space, then B^* is an Asplund space. (See Theorem 4.11b of Castillo and González [73].)

- (g) Verify that **if B is an infinite-dimensional Asplund space, then its dual space B^* has a quotient space which is an infinite-dimensional separable Banach space.**
- (h) Verify that **every reflexive Banach space (i) is an Asplund space and (ii) is the dual of an asplund space.** Deduce that (g) above includes as a special case (xxv)(f).

- (i) **Prove that if the Banach space B has a subspace E , where E is an infinite-dimensional Asplund space, then the dual space B^* has a quotient space which is an infinite-dimensional separable Banach space. In particular, this is the case if E is a reflexive Banach space.**
- (j) **Verify from the above that if B is a Banach space which contains as a subspace c_0 or ℓ_p , for $1 < p < \infty$, or any Hilbert space, then B^* has an infinite-dimensional separable quotient Banach space.**
- (xxvii) Using Exercises 8.3 #3(xi) prove that **if the Banach space B has Banach subspaces $B_1 \subset B_2 \subset \cdots \subset B_i \subset \cdots \subset \dots$ with each B_{i+1}/B_i having dimension 1, and $\bigcup_{i=1}^{\infty} B_i$ dense in B , then B has an infinite-dimensional separable quotient Banach space.**
- (xxviii)(a) Let B be an infinite-dimensional Banach space such that its dual space B^* has a separable infinite-dimensional Banach quotient space. Using (xviii) show that B^{***} has a separable infinite-dimensional Banach quotient space. Deduce that B^{*****} , B^{*****} , etc. have infinite-dimensional separable quotient Banach spaces.
- (b) Let B be a Banach space with an infinite-dimensional Banach subspace E . If E^* has a separable infinite-dimensional Banach quotient space, show that B^{***} has a separable infinite-dimensional Banach quotient space. Deduce that B^{*****} , B^{*****} , etc. have infinite-dimensional separable quotient Banach spaces.
- (c) **Deduce from the above that if a Banach space B has a subspace E which is an infinite-dimensional Asplund space, then the dual spaces B^{***} , B^{*****} , etc have infinite-dimensional separable quotient Banach spaces.**

10.4 Stone-Čech Compactification

10.4.1 Definition. Let (X, \mathcal{T}) be a topological space, $(\beta X, \mathcal{T}')$ a compact Hausdorff space and $\beta: (X, \mathcal{T}) \rightarrow (\beta X, \mathcal{T}')$ a continuous mapping, then $(\beta X, \mathcal{T}')$ together with the mapping β is said to be the **Stone-Čech compactification** of (X, \mathcal{T}) if for any compact Hausdorff space (Y, \mathcal{T}'') and any continuous mapping $\phi: (X, \mathcal{T}) \rightarrow (Y, \mathcal{T}'')$, there exists a unique continuous mapping

$\Phi: (\beta X, \mathcal{T}') \rightarrow (Y, \mathcal{T}'')$ such that $\Phi \circ \beta = \phi$; that is, the diagram below commutes:

$$\begin{array}{ccc}
 (X, \mathcal{T}) & \xrightarrow{\beta} & (\beta X, \mathcal{T}') \\
 & \searrow \phi & \downarrow \Phi \\
 & & (Y, \mathcal{T}'')
 \end{array}$$

WARNING The mapping β is usually not surjective, so $\beta(X)$ is usually not equal to βX .

10.4.2 Remark. Those familiar with category theory should immediately recognize that the existence of the Stone-Čech compactification follows from the Freyd Adjoint Functor Theorem using the forgetful functor from the category of compact Hausdorff spaces and continuous functions to the category of topological spaces and continuous functions. For a discussion of this see MacLane [269], Freyd [140]¹⁰

While the Stone-Čech compactification exists for all topological spaces, it assumes more significance in the case of Tychonoff spaces. For the mapping β is an embedding if and only if the space (X, \mathcal{T}) is Tychonoff. The “only if” part of this is clear, since the compact Hausdorff space $(\beta X, \mathcal{T}')$ is a Tychonoff space and so, therefore, is any subspace of it.

¹⁰Peter Freyd’s book “Abelian categories: An introduction to the theory of functors” is available as a free download at various sites including

<http://www.emis.de/journals/TAC/reprints/articles/3/tr3.pdf>.

We now proceed to prove the existence of the Stone-Ćech compactification for Tychonoff spaces and of showing that the map β is an embedding in this case.

10.4.3 Lemma. Let (X, \mathcal{T}) and (Y, \mathcal{T}') be Tychonoff spaces and $\mathcal{F}(X)$ and $\mathcal{F}(Y)$ the family of all continuous mappings of X and Y into $[0, 1]$, respectively. Further let e_X and e_Y be the evaluation maps of X into $\prod_{f \in \mathcal{F}(X)} I_f$ and Y into $\prod_{g \in \mathcal{F}(Y)} I_g$, respectively, where $I_f \cong I_g \cong [0, 1]$, for each f and g . If ϕ is any continuous mapping of X into Y , then there exists a continuous mapping Φ of $\prod_{f \in \mathcal{F}(X)} I_f$ into $\prod_{g \in \mathcal{F}(Y)} I_g$ such that $\Phi \circ e_X = e_Y \circ \phi$; that is, the diagram below commutes.

$$\begin{array}{ccc}
 (X, \mathcal{T}) & \xrightarrow{\phi} & (Y, \mathcal{T}') \\
 \downarrow e_X & & \downarrow e_Y \\
 \prod_{f \in \mathcal{F}(X)} I_f & \xrightarrow{\Phi} & \prod_{g \in \mathcal{F}(Y)} I_g
 \end{array}$$

Further, $\Phi(\overline{e_X(X)}) \subseteq \overline{e_Y(Y)}$.

Proof. Let $\prod_{f \in \mathcal{F}(X)} x_f \in \prod_{f \in \mathcal{F}(X)} I_f$. Define $\Phi\left(\prod_{f \in \mathcal{F}(X)} x_f\right) = \prod_{g \in \mathcal{F}(Y)} y_g$, where y_g is defined as follows: as $g \in \mathcal{F}(Y)$, g is continuous map from (Y, \mathcal{T}') into $[0, 1]$. So $g \circ \phi$ is a continuous map from (X, \mathcal{T}) into $[0, 1]$. Thus $g \circ \phi = f$, for some $f \in \mathcal{F}(X)$. Then put $y_g = x_f$, for this f , and the mapping Φ is now defined.

To prove continuity of Φ , let $U = \prod_{g \in \mathcal{F}(Y)} U_g$ be a basic open set containing $\Phi\left(\prod_{f \in \mathcal{F}(X)} x_f\right) = \prod_{g \in \mathcal{F}(Y)} y_g$. Then $U_g = I_g$ for all $g \in \mathcal{F}(Y) \setminus \{g_{i_1}, \dots, g_{i_n}\}$, for g_{i_1}, \dots, g_{i_n} . Put $f_{i_1} = g_{i_1} \circ \phi, f_{i_2} = g_{i_2} \circ \phi, \dots, f_{i_n} = g_{i_n} \circ \phi$. Now define $V = \prod_{f \in \mathcal{F}(X)} V_f$, where $V_f = I_f$, for some $f \in \mathcal{F}(X) \setminus \{f_{i_1}, f_{i_2}, \dots, f_{i_n}\}$, and $V_{f_{i_1}} = U_{g_{i_1}}, V_{f_{i_2}} = U_{g_{i_2}}, \dots, V_{f_{i_n}} = U_{g_{i_n}}$. Clearly $\prod_{f \in \mathcal{F}(X)} x_f \in V$ and $\Phi(V) \subseteq U$. So Φ is continuous.

To see that the diagram commutes, observe that

$$\Phi(e_X(x)) = \Phi\left(\prod_{f \in \mathcal{F}(X)} f(x)\right) = \prod_{g \in \mathcal{F}(Y)} g(\phi(x)), \text{ for all } x \in X.$$

So $\Phi \circ e_X = e_Y \circ \phi$.

Finally as Φ is continuous, $\Phi(\overline{e_X(X)}) \subseteq \overline{e_Y(Y)}$, as required. □

10.4.4 Lemma. Let Φ_1 and Φ_2 be continuous mappings of a topological space (X, \mathcal{T}) into the Hausdorff space (Y, \mathcal{T}') . If Z is a dense subset of (X, \mathcal{T}) and $\Phi_1(z) = \Phi_2(z)$ for all $z \in Z$, then $\Phi_1 = \Phi_2$ on X .

Proof. Suppose $\Phi_1(x) \neq \Phi_2(x)$, for some $x \in X$. Then as (Y, \mathcal{T}') is Hausdorff, there exist open sets $U \ni \Phi_1(x)$ and $V \ni \Phi_2(x)$, with $U \cap V = \emptyset$. So $\Phi_1^{-1}(U) \cap \Phi_2^{-1}(V)$ is an open set containing x .

As Z is dense in (X, \mathcal{T}) , there exists a $z \in Z$ such that $z \in \Phi_1^{-1}(U) \cap \Phi_2^{-1}(V)$. So $\Phi_1(z) \in U$ and $\Phi_2(z) \in V$. But $\Phi_1(z) = \Phi_2(z)$. So $U \cap V \neq \emptyset$, which is a contradiction.

Hence $\Phi_1(x) = \Phi_2(x)$, for all $x \in X$. □

10.4.5 Proposition. Let (X, \mathcal{T}) be any Tychonoff space, $\mathcal{F}(X)$ the family of continuous mappings of (X, \mathcal{T}) into $[0, 1]$, and e_X the evaluation map of (X, \mathcal{T}) into $\prod_{f \in \mathcal{F}(X)} I_f$, where each $I_f \cong [0, 1]$. Put $(\beta X, \mathcal{T}')$ equal to $\overline{e_X(X)}$ with the subspace topology and $\beta : (X, \mathcal{T}) \rightarrow (\beta X, \mathcal{T}')$ equal to the mapping e_X . Then $(\beta X, \mathcal{T}')$ together with the mapping β is the Stone-Čech compactification of (X, \mathcal{T}) .

Proof. Firstly observe that $(\beta X, \mathcal{T}')$ is indeed a compact Hausdorff space, as it is a closed subspace of a compact Hausdorff space.

Let ϕ be any continuous mapping of (X, \mathcal{T}) into any compact Hausdorff space (Y, \mathcal{T}'') . We are required to find a mapping Φ as in Definition 10.4.1 so that the diagram there commutes and show that ϕ is unique.

Let $\mathcal{F}(Y)$ be the family of all continuous mappings of (Y, \mathcal{T}'') into $[0, 1]$ and e_Y the evaluation mapping of (Y, \mathcal{T}'') into $\prod_{g \in \mathcal{F}(Y)} I_g$, where each $I_g \cong [0, 1]$.

By Lemma 10.4.3, there exists a continuous mapping $\Gamma : \prod_{f \in \mathcal{F}(X)} I_f \rightarrow \prod_{g \in \mathcal{F}(Y)} I_g$, such that $e_Y \circ \phi = \Gamma \circ e_X$, and $\Gamma(\overline{e_X(X)}) \subseteq \overline{e_Y(Y)}$; that is, $\Gamma(\beta X) \subseteq \overline{e_Y(Y)}$.

As (Y, \mathcal{T}'') is a compact Hausdorff space and e_Y is one-to-one, we see that $\overline{e_Y(Y)} = e_Y(Y)$ and $e_Y : (Y, \mathcal{T}'') \rightarrow (e_Y(Y), \mathcal{T}''')$ is a homeomorphism, where \mathcal{T}''' is the subspace topology on $e_Y(Y)$. So $e_Y^{-1} : (e_Y(Y), \mathcal{T}''') \rightarrow (Y, \mathcal{T}'')$ is a homeomorphism.

Put $\Phi = e_Y^{-1} \circ \Gamma$ so that Φ is a continuous mapping of $(\beta X, \mathcal{T}')$ into (Y, \mathcal{T}'') . Further,

$$\begin{aligned} \Phi(\beta(x)) &= \Phi(e_X(x)), \quad \text{for any } x \in X \\ &= e_Y^{-1}(\Gamma(e_X(x))) \\ &= e_Y^{-1}(e_Y(\phi(x))), \quad \text{as } e_Y \circ \phi = \Gamma \circ e_X \\ &= \phi(x). \end{aligned}$$

Thus $\Phi \circ \beta = \phi$, as required.

Now suppose there exist two continuous mappings Φ_1 and Φ_2 of $(\beta X, \mathcal{T}')$ into (Y, \mathcal{T}'') with $\Phi_1 \circ \beta = \phi$ and $\Phi_2 \circ \beta = \phi$. Then $\Phi_1 = \Phi_2$ on the dense subset $\beta(X)$ of $(\beta X, \mathcal{T}')$. So by Lemma 10.4.4, $\Phi_1 = \Phi_2$. Hence the mapping Φ is unique. \square

10.4.6 Remark. In Definition 10.4.1 referred to the Stone-Čech compactification implying that for each (X, \mathcal{T}) there is a unique $(\beta X, \mathcal{T}')$. The next Proposition indicates in precisely what sense this is true. However we first need a lemma.

10.4.7 Lemma. Let (X, \mathcal{T}) be a topological space and let (Z, \mathcal{T}_1) together with a mapping $\beta: (X, \mathcal{T}) \rightarrow (Z, \mathcal{T}_1)$ be a Stone-Čech compactification of (X, \mathcal{T}) . Then $\beta(X)$ is dense in (Z, \mathcal{T}_1) .

Proof. Suppose $\beta(X)$ is not dense in (Z, \mathcal{T}_1) . Then there exists an element $z_0 \in Z \setminus \overline{\beta(X)}$. As (Z, \mathcal{T}_1) is a compact Hausdorff space, by Remark 10.3.28, it is a Tychonoff space.

Observing that $Z \setminus \overline{\beta(X)}$ is an open set containing z , we deduce that there exists a continuous mapping $\Phi_1: (Z, \mathcal{T}_1) \rightarrow [0, 1]$ with $\Phi_1(z_0) = 1$ and $\Phi_1(\overline{\beta(X)}) = \{0\}$. Also there exists a continuous mapping $\Phi_2: (Z, \mathcal{T}_1) \rightarrow [0, \frac{1}{2}]$ with $\Phi_2(z_0) = \frac{1}{2}$ and $\Phi_2(\overline{\beta(X)}) = \{0\}$. So we have the following diagrams which commute

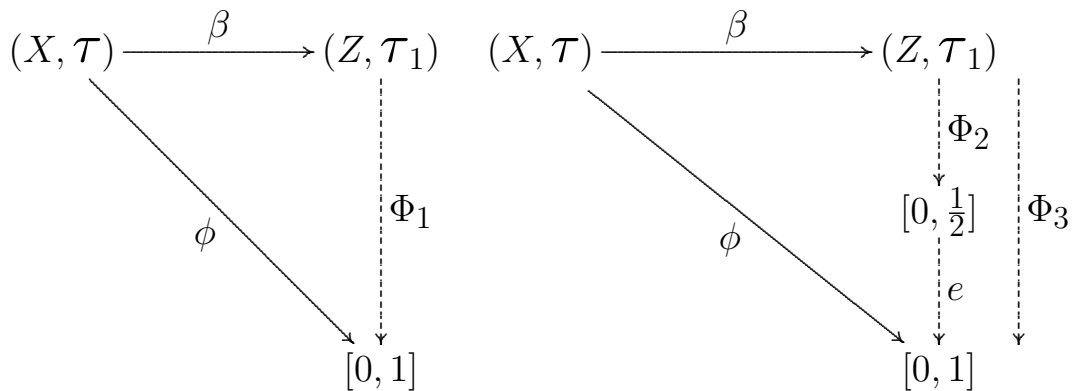

where $\phi(x) = 0$, for all $x \in X$ and Φ_3 is defined by $\Phi_3 = e \circ \Phi_2$, where e is the natural embedding of $[0, \frac{1}{2}]$ into $[0, 1]$. We see that the uniqueness of the mapping Φ in Definition 10.4.1 implies that $\Phi_1 = \Phi_3$, which is clearly false as $\Phi_1(z_0) = 1$ and $\Phi_3(z_0) = \frac{1}{2}$. So our supposition is false and hence $\beta(X)$ is dense in (Z, \mathcal{T}_1) . □

10.4.8 Proposition. Let (X, \mathcal{T}) be a topological space and (Z_1, \mathcal{T}_1) together with a mapping $\beta_1: (X, \mathcal{T}) \rightarrow (Z_1, \mathcal{T}_1)$ a Stone-Čech compactification of (X, \mathcal{T}) . If (Z_2, \mathcal{T}_2) together with a mapping $\beta_2: (X, \mathcal{T}) \rightarrow (Z_2, \mathcal{T}_2)$ is also a Stone-Čech compactification of (X, \mathcal{T}) then $(Z_1, \mathcal{T}_1) \cong (Z_2, \mathcal{T}_2)$. Indeed, there exists a homeomorphism $\Theta: (Z_1, \mathcal{T}_1) \rightarrow (Z_2, \mathcal{T}_2)$ such that $\Theta \circ \beta_1 = \beta_2$.

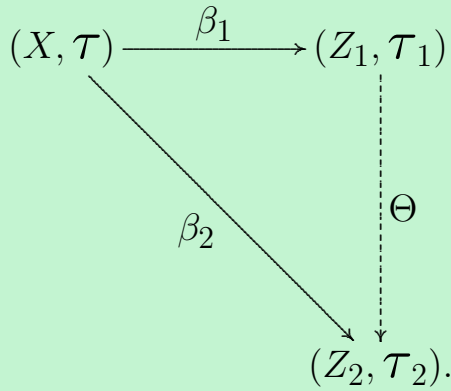

Proof. As (Z_1, \mathcal{T}_1) together with β_1 is a Stone-Čech compactification of (X, \mathcal{T}) and β_2 is a continuous mapping of (X, \mathcal{T}) into the compact Hausdorff space (Z_2, \mathcal{T}_2) , there exists a continuous mapping $\Theta: (Z_1, \mathcal{T}_1) \rightarrow (Z_2, \mathcal{T}_2)$, such that $\Theta \circ \beta_1 = \beta_2$.

Similarly there exists a continuous map $\Theta_1: (Z_2, \mathcal{T}_2) \rightarrow (Z_1, \mathcal{T}_1)$ such that $\Theta_1 \circ \beta_2 = \beta_1$. So for each $x \in X$, $\Theta_1(\Theta(\beta_1(x))) = \Theta_1(\beta_2(x)) = \beta_1(x)$; that is, if id_{Z_1} is the identity mapping on (Z_1, \mathcal{T}_1) then $\Theta_1 \circ \Theta = \text{id}_{Z_1}$ on $\beta_1(X)$, which by Lemma 10.4.7 is dense in (Z_1, \mathcal{T}_1) . So, by Lemma 10.4.4, $\Theta_1 \circ \Theta = \text{id}_{Z_1}$ on Z_1 .

Similarly $\Theta \circ \Theta_1 = \text{id}_{Z_2}$ on Z_2 . Hence $\Theta = \Theta_1^{-1}$ and as both are continuous this means that Θ is a homeomorphism. □

10.4.9 Remark. Note that if (X, \mathcal{T}) is any Tychonoff space and $(\beta X, \mathcal{T}')$ together with $\beta: (X, \mathcal{T}) \rightarrow (\beta X, \mathcal{T}')$ is its Stone-Čech compactification then the proof of Proposition 10.4.5 shows that β is an embedding. Indeed **it is usual**, in this case, **to identify X with βX , and so regard (X, \mathcal{T}) as a subspace of $(\beta X, \mathcal{T}')$** . We, then, do not mention the embedding β and talk about $(\beta X, \mathcal{T}')$ as the Stone-Čech compactification. □

10.4.10 Remark. For the case that (X, \mathcal{T}) is a compact Hausdorff space, the Stone-Čech compactification of (X, \mathcal{T}) is (X, \mathcal{T}) itself. Obviously (X, \mathcal{T}) together with the identity mapping into itself has the required property of a Stone-Čech compactification. By uniqueness, it is the Stone-Čech compactification. This could also be seen from the proof of [Proposition 10.4.5](#) where we saw that for the compact Hausdorff space (Y, \mathcal{T}'') the mapping $e_Y: (Y, \mathcal{T}'') \rightarrow (e_Y(Y), \mathcal{T}''')$ is a homeomorphism. \square

10.4.11 Remark. Stone-Čech compactifications of even nice spaces are usually complicated. For example $[0, 1]$ is not the Stone-Čech compactification of $(0, 1]$, since the continuous mapping $\phi: (0, 1] \rightarrow [-1, 1]$ given by $\phi(x) = \sin(\frac{1}{x})$ does not extend to a continuous map $\Phi: [0, 1] \rightarrow [-1, 1]$. Indeed it can be shown that the Stone-Čech compactification of $(0, 1]$ is not metrizable. We shall conclude this section by proving that the Stone-Čech compactification of $\mathbb{R}, \mathbb{Q}, (0, 1]$, and \mathbb{N} each have cardinality 2^c . \square

[Proposition 10.4.12](#) follows from our construction of the Stone-Čech compactification in [Proposition 10.4.5](#).

10.4.12 Proposition. Let (X, \mathcal{T}) be a topological space, (K, \mathcal{T}_1) a compact Hausdorff space, and $\theta: (X, \mathcal{T}) \rightarrow (K, \mathcal{T}_1)$ a continuous map. If for every continuous map $\phi: (X, \mathcal{T}) \rightarrow [0, 1]$ there exists a unique continuous map $\Phi: (K, \mathcal{T}_1) \rightarrow [0, 1]$ such that $\theta \circ \Phi = \phi$, then (K, \mathcal{T}_1) is the Stone-Čech compactification of (X, \mathcal{T}) .

Proof. Exercise. \square

10.4.13 Proposition. Let \mathbb{N} have its discrete subspace topology in \mathbb{R} and let $\beta\mathbb{R}$ be the Stone-Ćech compactification of \mathbb{R} . If the closure in $\beta\mathbb{R}$ of \mathbb{N} is denoted by $\text{cl}_{\beta\mathbb{R}}\mathbb{N}$, then $\text{cl}_{\beta\mathbb{R}}\mathbb{N}$ is $\beta\mathbb{N}$, the Stone-Ćech compactification of \mathbb{N} .

Proof. Let θ be any continuous map of \mathbb{N} into $[0, 1]$. By the [Tietze Extension Theorem 10.3.51](#), there is a continuous extension $\phi : \mathbb{R} \rightarrow [0, 1]$ of θ . Therefore there exists a continuous extension $\Phi : \beta\mathbb{R} \rightarrow [0, 1]$ of ϕ . So $\Phi|_{\text{cl}_{\beta\mathbb{R}}(\mathbb{N})}$, the restriction of the map Φ to $\text{cl}_{\beta\mathbb{R}}\mathbb{N}$, maps $\text{cl}_{\beta\mathbb{R}}\mathbb{N}$ to $[0, 1]$ and is a continuous extension of θ . As \mathbb{N} is dense in $\text{cl}_{\beta\mathbb{R}}\mathbb{N}$, this is the unique continuous extension. So by [Proposition 10.4.12](#), $\text{cl}_{\beta\mathbb{R}}\mathbb{N}$ is $\beta\mathbb{N}$. \square

10.4.14 Remark. It can be proved in a similar manner to that in [Proposition 10.4.13](#) that $\text{cl}_{\beta\mathbb{Q}}\mathbb{N} = \beta\mathbb{N}$. \square

10.4.15 Proposition. Let (X, \mathcal{T}) be any separable topological space. Then $\text{card } \beta X \leq \text{card } \beta\mathbb{N}$.

Proof. As (X, \mathcal{T}) is separable, it has a dense countable subspace (Y, \mathcal{T}_1) . So there exists a continuous surjective map $\gamma : \mathbb{N} \rightarrow (Y, \mathcal{T}_1)$. Thus there exists a continuous map $\Phi : \beta\mathbb{N} \rightarrow \beta X$ which has dense image in βX . But as the image is compact and βX is Hausdorff, $\Phi(\beta\mathbb{N}) = \beta X$, from which the proposition immediately follows. \square

10.4.16 Proposition. $\text{card } \beta\mathbb{N} = \text{card } \beta\mathbb{Q} = \text{card } \beta\mathbb{R}$.

Proof. This follows immediately from [Propositions 10.4.15](#) and [10.4.13](#) and [Remark 10.4.14](#). \square

10.4.17 Proposition. $\text{card } \beta\mathbb{N} = \text{card } \beta\mathbb{Q} = \text{card } \beta\mathbb{R} = 2^{\mathfrak{c}}$.

Proof. By The [Corollary 10.3.42](#) of the Hewitt-Marczewski-Pondiczery Theorem 10.3.41, the compact Hausdorff space $[0, 1]^{\mathfrak{c}}$ is separable. So by [Proposition 10.4.15](#), $\text{card } [0, 1]^{\mathfrak{c}} \leq \text{card } \beta\mathbb{N}$; that is, $2^{\mathfrak{c}} \leq \text{card } \beta\mathbb{N}$.

By the construction in [Proposition 10.4.5](#), $\beta\mathbb{N}$ is a subspace of $[0, 1]^I$, where I is the set of (continuous) functions from \mathbb{N} to $[0, 1]$. So $\text{card } I = \mathfrak{c}^{\aleph_0} = \mathfrak{c}$. Then $\text{card } ([0, 1]^I) = \mathfrak{c}^{\mathfrak{c}} = 2^{\mathfrak{c}}$. Thus $\text{card } \beta\mathbb{N} \leq 2^{\mathfrak{c}}$. Hence $\text{card } \beta\mathbb{N} = 2^{\mathfrak{c}}$. The proposition then follows from [Proposition 10.4.17](#). \square

10.4.18 Proposition. Let X be any unbounded subset of \mathbb{R}^n , for any $n \in \mathbb{N}$. If \mathcal{T} is the euclidean subspace topology on X , then βX , the Stone-Ćech compactification of (X, \mathcal{T}) , has a subspace homeomorphic to $\beta\mathbb{N}$, and so $\text{card } (\beta X) = 2^{\mathfrak{c}}$.

Proof. Exercise. \square

10.4.19 Corollary. Let (X, \mathcal{T}) be any closed subspace of \mathbb{R}^n , $n \in \mathbb{N}$. Then (X, \mathcal{T}) is compact if and only if $\text{card } (\beta X) \neq 2^{\mathfrak{c}}$.

Proof. Exercise. \square

10.4.20 Corollary. If (X, \mathcal{T}) is an infinite discrete topological space of cardinality m , then $\text{card } (\beta X) = 2^{2^m}$.

Proof. Exercise. \square

Exercises 10.4

1. Let (X, \mathcal{T}) be a Tychonoff space and $(\beta X, \mathcal{T}')$ its Stone-Čech compactification. Prove that (X, \mathcal{T}) is connected if and only if $(\beta X, \mathcal{T}')$ is connected.
[Hint: Firstly verify that providing (X, \mathcal{T}) has at least 2 points it is connected if and only if there does not exist a continuous map of (X, \mathcal{T}) onto the discrete space $\{0, 1\}$.]
2. Let (X, \mathcal{T}) be a Tychonoff space and $(\beta X, \mathcal{T}')$ its Stone-Čech compactification. If (A, \mathcal{T}_1) is a subspace of $(\beta X, \mathcal{T}')$ and $A \supseteq X$, prove that $(\beta X, \mathcal{T}')$ is also the Stone-Čech compactification of (A, \mathcal{T}_1) .
[Hint: Verify that every continuous mapping of (X, \mathcal{T}) into $[0, 1]$ can be extended to a continuous mapping of (A, \mathcal{T}_1) into $[0, 1]$. Then use the construction of $(\beta X, \mathcal{T}')$.]
3. Let (X, \mathcal{T}) be a dense subspace of a compact Hausdorff space (Z, \mathcal{T}_1) . If every continuous mapping of (X, \mathcal{T}) into $[0, 1]$ can be extended to a continuous mapping of (Z, \mathcal{T}_1) into $[0, 1]$, prove that (Z, \mathcal{T}_1) is the Stone-Čech compactification of (X, \mathcal{T}) .
4. Prove that $\text{card } \beta(0, 1) = \text{card } \beta(0, 1] = \text{card } \beta\mathbb{P} = 2^c$, where \mathbb{P} is the topological space of irrational numbers with the euclidean topology.
5. Prove [Proposition 10.4.18](#) and [Corollary 10.4.19](#).
6. Is it true that if X is an unbounded set in an infinite-dimensional normed vector space, then $\text{card } (\beta X) \geq 2^c$?
7. Using a similar method to that in the proof of [Proposition 10.4.17](#), prove [Corollary 10.4.20](#).

10.5 Postscript

At long last we defined the product of an arbitrary number of topological spaces and proved the general Tychonoff Theorem. (An alternative and more elegant proof of the Tychonoff Theorem using the concept of a filter appears in [Appendix 6](#).) We also extended the Embedding Lemma to the general case. This we used to characterize the Tychonoff spaces as those which are homeomorphic to a subspace of a cube (that is, a product of copies of $[0, 1]$).

[Urysohn's Lemma](#) allowed us to obtain the following relations between the separation properties:

$$T_4 \Rightarrow T_{3\frac{1}{2}} \Rightarrow T_3 \Rightarrow T_2 \Rightarrow T_1 \Rightarrow T_0.$$

Further, each of the properties compact Hausdorff and metrizable imply T_4 .

We have also seen a serious metrization theorem – namely [Urysohn's Metrization Theorem](#), which says that every regular second countable Hausdorff space is metrizable.

We introduced the Stone-Čech compactification, which is a rich and serious topic of study in its own right. (See Gillman and Jerison [156]; Hindman and Strauss [187]; Walker [415].) In order to show that the Stone-Čech compactification is huge, we proved other important results. One of these is the [Hewitt-Marczewski-Pondiczery Theorem 10.3.41](#) which in particular showed the surprising fact that a product of \mathfrak{c} copies of \mathbb{R} is separable. In a series of steps we proved the [Tietze Extension Theorem 10.3.51](#) and stated it in a slightly more general form than is usual in most books. With the aid of these results we were able to prove, in [Proposition 10.4.18](#), that if X is any unbounded subset of \mathbb{R}^n , $n \in \mathbb{N}$, then $\text{card}(\beta X) = 2^{\mathfrak{c}}$. In particular, $\text{card} \beta\mathbb{N} = \text{card} \beta\mathbb{Q} = \text{card} \beta\mathbb{R} = \text{card} \beta\mathbb{P} = 2^{\mathfrak{c}}$.

In [Exercises 10.3 #33](#) we have some beautiful results from Banach space Theory. These include the Banach-Alaoglu Theorem, the Hahn-Banach Theorem, and a wealth of information on the duals of Banach spaces, the weak topology, the weak*-topology on the dual space, reflexive Banach spaces, weakly compactly generated Banach spaces, the annihilator, quotients of Banach spaces, and the Open Question known as the Separable Quotient Problem. In particular, we show that every infinite-

dimensional reflexive Banach space has a quotient Banach space which is a separable and infinite-dimensional Banach space. It is known, but not proved here, that every infinite-dimensional WCG space and every infinite-dimensional dual of a Banach space has a quotient Banach space which is infinite-dimensional and separable.

10.6 Credit for Images

1. Clifford Hugh Dowker. Copyright information:
<http://www-history.mcs.st-andrews.ac.uk/Miscellaneous/Copyright.html>
2. Edwin Hewitt. MFO. https://opc.mfo.de/detail?photo_id=1709
3. Edward Marczewski. MFO. https://opc.mfo.de/detail?photo_id=2747
4. Andrey Nikolayevich Tychonoff (or Tikhonov). Photo taken by Konrad Jacobs. Copy from The Oberwolfach Photo Collection. The Oberwolfach Photo Collection is based on Prof. Konrad Jacobs' (Erlangen) large collection of photographs of mathematicians from all over the world. In the 1950's Prof. Jacobs started to make copies of the photographs he had taken and donated these copies to the MFO. In 2005 he transferred his whole collection completely with all rights to the MFO. The collection also contains a lot of pictures taken by Prof. George M. Bergman (Berkeley), whose pictures were scanned by the MFO and added to the database in 2010/11. Copyright Information / Disclaimer The Mathematisches Forschungsinstitut Oberwolfach gGmbH (MFO) owns the copyright to most of the images used on the Oberwolfach Photo Collection website. Those images labelled with "Copyright: MFO" can be used on the terms of the Creative Commons License Attribution-Share Alike 2.0 Germany.

Chapter 11

Quotient Spaces

Introduction

We have seen how to create new topological spaces from given topological spaces using the operation of forming a subspace (of a topological space) and the operation of forming a (finite or infinite) product of a set of topological spaces. In this chapter we introduce a third operation, namely that of forming a quotient space (of a topological space). As examples we shall see the Klein bottle and Möbius strip.

11.1 Quotient Spaces

11.1.1 Definitions. Let (X, \mathcal{T}) and (Y, \mathcal{T}_1) be topological spaces. Then (Y, \mathcal{T}_1) is said to be a **quotient space** of (X, \mathcal{T}) if there exists a surjective mapping $f : (X, \mathcal{T}) \rightarrow (Y, \mathcal{T}_1)$ with the property (*).

$$\text{For each subset } U \text{ of } Y, \quad U \in \mathcal{T}_1 \iff f^{-1}(U) \in \mathcal{T}. \quad (*)$$

A surjective mapping f with the property(*) is said to be a **quotient mapping**.

11.1.2 Remark. From [Definitions 11.1.1](#) it is clear that every quotient mapping is a continuous map. □

11.1.3 Remark. Property (*) is equivalent to property (**).

For each subset A of Y , A is closed in $(Y, \mathcal{T}_1) \iff f^{-1}(A)$ is closed in (X, \mathcal{T}) .
(**)

□

11.1.4 Remark. Let f be a one-to-one mapping of a topological space (X, \mathcal{T}) onto a topological space (Y, \mathcal{T}_1) . Then f is a homeomorphism if and only if it is a quotient mapping. □

11.1.5 Proposition. Let f be a continuous mapping of a compact space (X, \mathcal{T}) onto a Hausdorff space (Y, \mathcal{T}_1) . Then f is a quotient mapping.

Proof. We shall use property(**) above. Let A be a subset of Y . If $f^{-1}(A)$ is closed in (X, \mathcal{T}) , then by [Proposition 7.2.4](#) it is compact. As f is continuous, by [Proposition 7.2.1](#), $f(f^{-1}(A))$ is a compact subspace of the Hausdorff space (Y, \mathcal{T}_1) , and therefore by [Proposition 7.2.5](#) is closed in (Y, \mathcal{T}_1) . As f is surjective, $f(f^{-1}(A)) = A$, and we have that A is closed.

Conversely, if A is closed in (Y, \mathcal{T}_1) , then by continuity of f , $f^{-1}(A)$ is closed in (X, \mathcal{T}) .

Hence f has property(**) and so is a quotient mapping. □

As an immediate consequence of [Proposition 11.1.5](#) and [Remark 11.1.4](#) we obtain:

11.1.6 Corollary. Let f be a one-to one continuous mapping of a compact space (X, \mathcal{T}) onto a Hausdorff space (Y, \mathcal{T}_1) . Then f is a homeomorphism. □

11.1.7 Definitions. Let (X, \mathcal{T}) and (Y, \mathcal{T}_1) be topological spaces. A mapping $f : (X, \mathcal{T}) \rightarrow (Y, \mathcal{T}_1)$ is said to be a **closed mapping** if for every closed subset A of (X, \mathcal{T}) , $f(A)$ is closed in (Y, \mathcal{T}_1) . A function $f : (X, \mathcal{T}) \rightarrow (Y, \mathcal{T}_1)$ is said to be an **open mapping** if for every open subset A of (X, \mathcal{T}) , $f(A)$ is open in (Y, \mathcal{T}_1) .

11.1.8 Remark. In [Exercises 7.2 #5](#) we saw that there are examples of mappings f which are

- (i) open but not closed;
- (ii) closed but not open;
- (iii) open but not continuous;
- (iv) closed but not continuous;
- (v) continuous but not open;
- (vi) continuous but not closed,

and that **if (X, \mathcal{T}) and (Y, \mathcal{T}_1) are compact Hausdorff spaces and $f : (X, \mathcal{T}) \rightarrow (Y, \mathcal{T}_1)$ is a continuous mapping, then f is a closed mapping.**

11.1.9 Remark. Clearly **if $f : (X, \mathcal{T}) \rightarrow (Y, \mathcal{T}_1)$ is a surjective, continuous and open mapping, then it is also a quotient mapping.** Similarly **if f is a surjective, continuous and closed mapping, then it is a quotient mapping.** However, there exist quotient maps which are neither open nor closed maps.

11.1.10 Proposition. Let f be a continuous mapping of a compact space onto a Hausdorff space (Y, \mathcal{T}_1) . Then f is a closed mapping.

Proof. Let A be a closed subset of (X, \mathcal{T}) . Then A is compact by [Proposition 7.2.4](#). So by [Proposition 7.2.1](#), $f(A)$ is a compact subset of (Y, \mathcal{T}_1) . As (Y, \mathcal{T}_1) is Hausdorff, by [Proposition 7.2.5](#), $f(A)$ is a closed set. So f is a closed mapping. \square

11.1.11 Example. Let $f : [0, 1] \rightarrow \mathbf{S}^1$ be given by $f(x) = (\cos 2\pi x, \sin 2\pi x)$. Clearly f is continuous and surjective. By [Proposition 11.1.10](#), f is a closed mapping and by [Remark 11.1.9](#) is therefore also a quotient mapping. \square

Exercises 11.1

1. Verify [Remark 11.1.3](#).
2. Verify [Remark 11.1.4](#).
3. Verify both assertions in [Remark 11.1.9](#).
4. Let (X, \mathcal{T}) , (Y, \mathcal{T}_1) and (Z, \mathcal{T}_2) be topological spaces and $f : (X, \mathcal{T}) \rightarrow (Y, \mathcal{T}_1)$ and $g : (Y, \mathcal{T}_1) \rightarrow (Z, \mathcal{T}_2)$ be quotient maps. Prove that the map $g \circ f : (X, \mathcal{T}) \rightarrow (Z, \mathcal{T}_2)$ is a quotient map. (So **the composition of two quotient maps is a quotient map.**)
5. Noting the definition of \mathbf{S}^1 in [Exercises 6.1 #15](#), let $f : \mathbb{R} \rightarrow \mathbf{S}^1$ be given by $f(x) = (\cos 2\pi x, \sin 2\pi x)$. Show that f is a quotient mapping but not a closed mapping. Is f an open mapping?
6. Find an example of a quotient mapping which is neither an open mapping nor a closed mapping.
7. Show that every compact Hausdorff space is a quotient space of the Stone-Ćech compactification of a discrete space.
8. Let (X, \mathcal{T}) and (Y, \mathcal{T}_1) be topological spaces and $f : (X, \mathcal{T}) \rightarrow (Y, \mathcal{T}_1)$ a quotient mapping. Prove that if (X, \mathcal{T}) is a sequential space then (Y, \mathcal{T}_1) is also a sequential space. (See [Exercises 6.2](#).)
9. Let (X, \mathcal{T}) and (Y, \mathcal{T}_1) be topological spaces and $f : (X, \mathcal{T}) \rightarrow (Y, \mathcal{T}_1)$ a quotient mapping. If (X, \mathcal{T}) is metrizable, is (Y, \mathcal{T}_1) necessarily metrizable?
10. Is a Hausdorff quotient space of a k_ω -space necessarily a k_ω -space?
11. Is a quotient space of a k -space necessarily a k -space?

12. Let (X, \mathcal{T}) and (Y, \mathcal{T}_1) be topological spaces and f a quotient mapping of (X, \mathcal{T}) onto (Y, \mathcal{T}_1) .
- (i) If (X, \mathcal{T}) is a metrizable space, prove that (Y, \mathcal{T}_1) is a sequential space. (See [Exercises 6.2 #11.](#))
 - (ii) If (X, \mathcal{T}) is a first countable space, prove that (Y, \mathcal{T}_1) is a sequential space.
 - (iii)* Can sequential spaces be characterized as quotient spaces of metrizable spaces?

11.2 Identification Spaces

We begin by recalling the definition of an equivalence relation.

11.2.1 Definitions. A binary relation \sim on a set X is said to be an **equivalence relation** if it is reflexive, symmetric and transitive; that is, for all $a, b, c \in X$,

- (i) $a \sim a$ (reflexive);
- (ii) $a \sim b \implies b \sim a$ (symmetric);
- (iii) $a \sim b$ and $b \sim c \implies a \sim c$ (transitive).

If $a, b \in X$, then a and b are said to be in the same **equivalence class** if $a \sim b$.

11.2.2 Remark. Note that $=$ is an equivalence relation on the set \mathbb{R} of all real numbers and \cong (homeomorphic) is an equivalence relation on any set of topological spaces. □

11.2.3 Remark. Let X and Y be sets and f a mapping of X onto Y . We can define an equivalence relation \sim on the set X as follows:

$$\text{for } a, b \in X, \quad a \sim b \iff f(a) = f(b).$$

So two points $a, b \in X$ are in the same equivalence class if and only if $f(a) = f(b)$. □

11.2.4 Remark. Using Remark 11.2.3 we now observe that quotient spaces arise in a very natural way.

Let (X, \mathcal{T}) be any topological space and \sim any equivalence relation on X . Let Y be the set of all equivalence classes of \sim . We can denote Y by X/\sim . The natural topology to put on the set $Y = X/\sim$ is the quotient topology under the map which identifies the equivalence classes; that is, maps each equivalence class to a point.

Because of this example, quotient mappings are often called **identification mappings** and quotient spaces are often called **identification spaces**.

Of course, as we have seen in Remark 11.2.3, this example is in fact quite general, because if f is any mapping of a set X onto a set Y , we can define an equivalence relation by putting $a \sim b$ if and only if $f(a) = f(b)$, where $a, b \in X$. \square

11.2.5 Definition. For any space (X, \mathcal{T}) , the **cone (CX, \mathcal{T}_1) over X** is the quotient space $((X, \mathcal{T}) \times I)/\sim$, where I denotes the unit interval with its usual topology and \sim is the equivalence relation $(x, 0) \sim (x', 0)$, for all $x, x' \in X$; that is, $CX = ((X, \mathcal{T}) \times I)/(X \times \{0\})$.

11.2.6 Remark. Intuitively¹, CX is obtained from $X \times I$ by pinching $X \times \{0\}$ to a single point. So we make X into a cylinder and collapse one end to a point. The elements of CX are denoted by $\langle x, a \rangle$. It is readily verified that $x \mapsto \langle x, 1 \rangle$ is a homeomorphism of (X, \mathcal{T}) onto its image in (CX, \mathcal{T}_1) ; that is, it is an embedding. So we identify (X, \mathcal{T}) with the subspace $\{\langle x, 1 \rangle : x \in X\} \subset (CX, \mathcal{T}_1)$. \square

¹A useful introductory book on algebraic topology covering topics such as cone and suspension is "Algebraic Topology" by Allen Hatcher and is freely downloadable from <http://www.math.cornell.edu/~hatcher/AT/AT.pdf>. Our presentation here is based on Brown [62].

11.2.7 Example. If in Remark 11.2.6 the space X is a circle in the euclidean space \mathbb{R}^2 , then the cylinder $X \times I$ is a subspace of \mathbb{R}^3 and the cone CX is also a subspace of \mathbb{R}^3 , as indicated in the diagrams below.

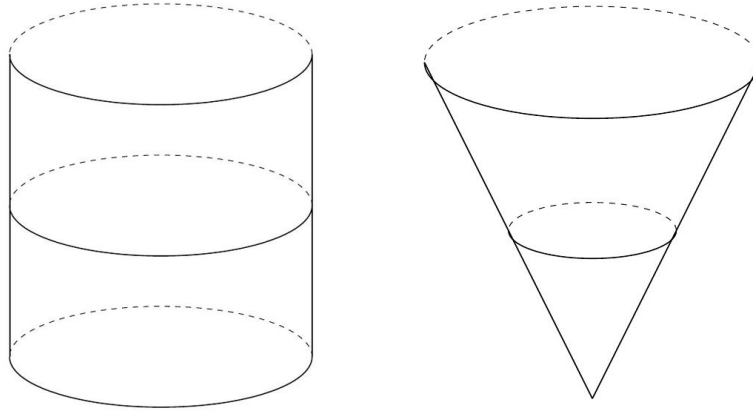

Note that if X is a disk in \mathbb{R}^2 rather than a circle, then the cone CX is a solid cone. □

We need a little notation before discussing cones further.

11.2.8 Definitions. Let $|\cdot|$ be the Euclidean norm on \mathbb{R}^n defined by $|\langle x_1, x_2, \dots, x_n \rangle| = \sqrt{x_1^2 + x_2^2 + \dots + x_n^2}$.

The **cell** E^n is defined by $E^n = \{x \in \mathbb{R}^n : |x| \leq 1\}$.

The **ball** B^n is defined by $B^n = \{x \in \mathbb{R}^n : |x| < 1\}$.

The **sphere** \mathbf{S}^{n-1} is defined by $\mathbf{S}^{n-1} = \{x \in \mathbb{R}^n : |x| = 1\}$.

We see that \mathbf{S}^1 is the unit circle in \mathbb{R}^2 , and $E^0 = B^0 = \{0\}$ and $\mathbf{S}^0 = \{-1, 1\}$.

Note that \mathbf{S}^{n-1} and E^n are closed bounded subsets of \mathbb{R}^n , and so by the Generalized Heine Borel Theorem 8.3.3, both are compact.

11.2.9 Proposition. For $m, n \in \mathbb{N}$, $E^m \times E^n$ is homeomorphic to E^{m+n} .

Proof. Exercise. □

11.2.12 Proposition. For each integer $n \geq 2$, the suspension, $S(\mathbf{S}^{n-1})$, of \mathbf{S}^{n-1} is homeomorphic to \mathbf{S}^n .

Proof. Define the sets E_+^n and E_-^n as follows:

$$E_+^n = \{(x, t) \in S^n : x \in \mathbb{R}^n, t \geq 0\} = \text{the northern hemisphere of } \mathbf{S}^n.$$

$$E_-^n = \{(x, t) \in S^n : x \in \mathbb{R}^n, t \leq 0\} = \text{the southern hemisphere of } \mathbf{S}^n.$$

Let $p : \mathbb{R}^{n+1} = \mathbb{R}^n \times \mathbb{R} \rightarrow \mathbb{R}^n$ be the projection map which omits the last coordinate. Then consider the map p restricted to E_+^n .

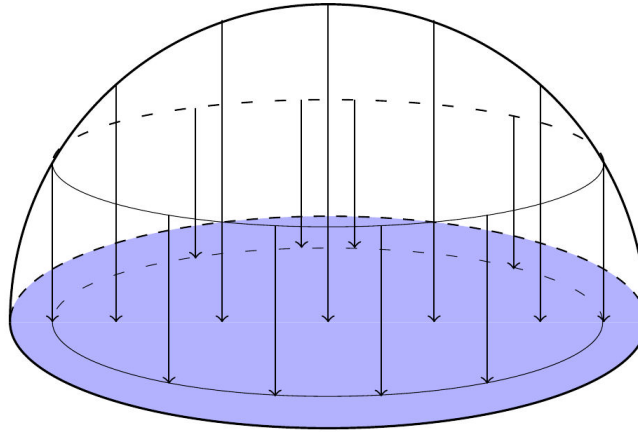

Then $p : E_+^n \rightarrow E_n$ is continuous, one-to-one and onto and hence is a homeomorphism, by the compactness of E_+^n . Similarly $p : E_-^n \rightarrow E_n$ is a homeomorphism.

Now let $\phi : (X, \mathcal{T}) \times I \rightarrow CX$ be the canonical quotient map, for any (X, \mathcal{T}) . Put $C^+X = \phi(X \times [1/2, 1])$ and $C^-X = \phi(X \times [0, 1/2])$.

It is readily verified that $\phi : (X, \mathcal{T}) \times [1/2, 1] \rightarrow C^+X$ and $\phi : (X, \mathcal{T}) \times [0, 1/2] \rightarrow C^-X$ are quotient maps. So we have a quotient map:

$$\begin{array}{ccccc} (X, \mathcal{T}) \times I & \longrightarrow & (X, \mathcal{T}) \times [0, 1/2] & \longrightarrow & C^-X \\ (x, t) & \longrightarrow & (x, t/2) & \longrightarrow & \phi(x, t/2) \end{array}$$

which shrinks $(X, \mathcal{T}) \times \{0\}$. So CX is homeomorphic to C^-X . Similarly the map $I \rightarrow [1/2, 1]$ given by $t \mapsto 1 - t/2$, yields CX is homeomorphic to C^+X .

Putting our results together we have $C^+\mathbf{S}^{n-1} \cong C^+S^{n-1} \cong E_+^n \cong E_+^n$. So $E_+^n \cong C^+\mathbf{S}^{n-1}$ and $E_-^n \cong C^-\mathbf{S}^{n-1}$ and these homeomorphisms agree on the set $E_+^n \cap E_-^n = \{(x, 0) : x \in \mathbb{R}^n\}$. They both map $(x, 0)$ to $(x, \frac{1}{2})$. Hence we can “glue” the homeomorphisms together to obtain $\mathbf{S}^n \cong S(\mathbf{S}^{n-1})$. \square

Exercises 11.2

1. If (X, \mathcal{T}) is a point, verify that the cone (CX, \mathcal{T}_1) is the unit interval $[0, 1]$.
2. Prove that **every topological space (X, \mathcal{T}) is homeomorphic to a subspace of a path-connected space** by verifying that the cone CX is path-connected.
3. Prove [Proposition 11.2.9](#).
4. Prove that E_+^n is a retract of \mathbf{S}^n , for $n \in \mathbb{N}$.

Reduced Cone and Reduced Suspension

5. Let (X, \mathcal{T}) be a topological space and $x_0 \in X$. Define the **reduced cone**, denoted by ΓX , as $\Gamma X = (X \times I)/(X \times \{0\} \cup \{x_0\} \times I)$ and the **reduced suspension**, denoted by ΣX , as $\Sigma X = (X \times I)/(X \times \{0, 1\} \cup \{x_0\} \times I)$. Prove that $\Gamma \mathbf{S}^{n-1} \cong E^n$ and that $\Sigma \mathbf{S}^{n-1} \cong \mathbf{S}^n$, for any positive integer $n \geq 2$.
6. Let (X, \mathcal{T}) be the topological space obtained from the real line \mathbb{R} with the euclidean topology by indentifying the set of all integers to a point; that is $n \sim m$ if and only if $n, m \in \mathbb{Z}$. Prove that (X, \mathcal{T}) is a sequential space which is not a first countable space. (See [Exercises 6.2 #11](#).)

11.3 Möbius Strip, Klein Bottle and Real Projective Space

11.3.1 Remark. It is not always easy to picture a 3-dimensional object, let alone a 4-dimensional one which cannot exist in 3-dimensional space, such as the Klein bottle. It is therefore useful and convenient to use 2-dimensional polygonal representations of figures in higher dimensions, where we adopt a convention for when edges are identified. A simple example will demonstrate how this is done.

11.3.2 Example. We represent a cylinder as a square with one pair of opposite sides identified. So the two sides labelled “b” are identified in such a way that the two vertices marked “A” are identified and the two vertices marked “B” are identified.

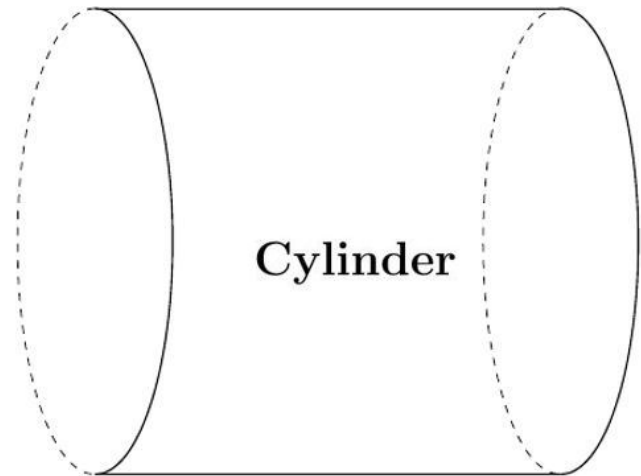
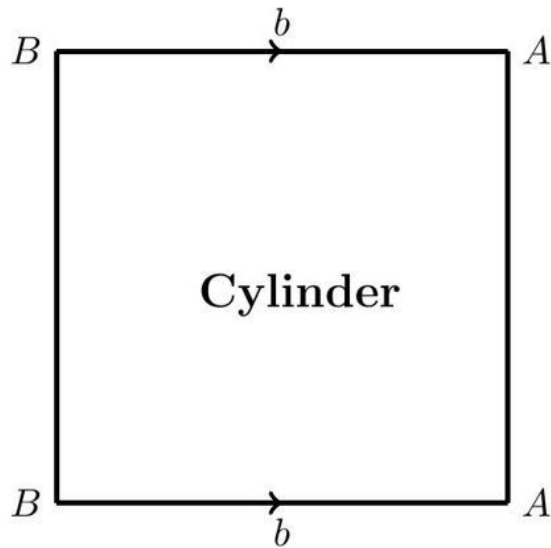

So the cylinder is the quotient space $I \times I / \sim$, where \sim is the equivalence relation on $I \times I$ given by $(t, 0) \sim (t, 1)$, for all $t \in I$. □

11.3.3 Example. The **Möbius strip** or **Möbius band**, denoted by \mathbb{M} , is defined to be the quotient space $I \times I / \sim$, where \sim is the equivalence relation $(t, 0) \sim (1 - t, 1)$, for all $t \in I$.

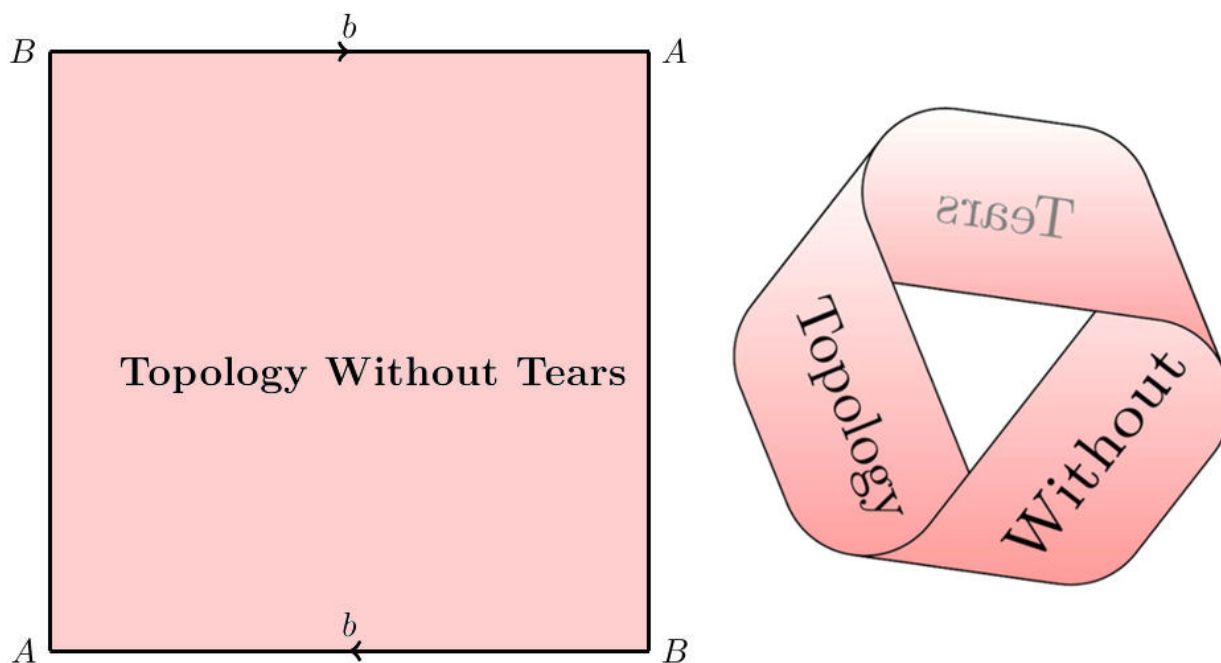

If an insect crawled along the entire length of the Möbius strip, it would return to its starting point without ever crossing an edge, but it would have crawled along both sides of the Möbius strip. \square

11.3.4 Examples. The **real projective plane**, denoted by $\mathbb{R}P^2$, is defined to be the quotient space $I \times I / \sim$, where \sim is the equivalence relation $(0, t) \sim (1, 1 - t)$ and $(t, 0) \sim (1 - t, 1)$, for all $t \in I$.

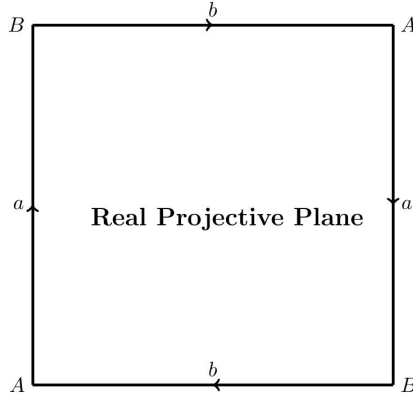

This is not a subspace of \mathbb{R}^3 , that is, it cannot be embedded in 3-dimensional euclidean space (without crossing itself).

While it is not immediately obvious, $\mathbb{R}P^2$ can be thought of as the space of all lines through the origin, but excluding the origin, in \mathbb{R}^3 . Each line is of course determined by a non-zero vector in \mathbb{R}^3 , unique up to scalar multiplication. $\mathbb{R}P^2$ is then the quotient space of $\mathbb{R}^3 \setminus \{0\}$ under the equivalence relation $v \sim \lambda v$, for all $\lambda \in \mathbb{R}$, $\lambda \neq 0$. (See also [Definitions A5.0.1](#) and the following discussion.)

In fact, we can generalize this to **real projective space**, denoted by $\mathbb{R}P^n$. Let $X = \mathbb{R}^{n+1} \setminus \{(0, 0, \dots, 0)\}$. Give X the topology \mathcal{T} as a subspace of \mathbb{R}^{n+1} .

Then $\mathbb{R}P^n$ is the quotient space $(X, \mathcal{T}) / \sim$, where the equivalence relation \sim is given by $(a_1, a_2, \dots, a_{n+1}) \sim (b_1, b_2, \dots, b_{n+1})$, if there exists a $\lambda \in \mathbb{R} \setminus \{0\}$, such that $b_i = \lambda a_i$, for $i = 1, 2, \dots, n + 1$.

Let $\phi : (X, \mathcal{T}) \rightarrow \mathbb{R}P^n$ be the quotient/identification map. Since $\mathbf{S}^n \subseteq X$, we can consider the restriction of ϕ to \mathbf{S}^n , namely $\phi : \mathbf{S}^n \rightarrow \mathbb{R}P^n$. Since

$$\phi((x_1, x_2, \dots, x_{n+1})) = \phi\left(\left(\frac{1}{\lambda}x_1, \frac{1}{\lambda}x_2, \dots, \frac{1}{\lambda}x_{n+1}\right)\right),$$

where $\lambda = |(x_1, x_2, \dots, x_{n+1})| = \sqrt{x_1^2 + x_2^2 + \dots + x_{n+1}^2}$ and $(\frac{1}{\lambda}x_1, \frac{1}{\lambda}x_2, \dots, \frac{1}{\lambda}x_{n+1}) \in \mathbf{S}^n$, we see that the map $\phi : \mathbf{S}^n \rightarrow \mathbb{R}P^n$ is surjective. It is continuous and, by the compactness of \mathbf{S}^n , is a quotient map. Clearly if $a, b \in \mathbf{S}^n$, then

$$\phi(a) = \phi(b) \iff a = (a_1, a_2, \dots, a_{n+1}) \text{ and } b = (-a_1, -a_2, \dots, -a_{n+1});$$

that is, a and b are antipodal points. (Antipodal points on a sphere are those which are diametrically opposite.) So $\mathbb{R}P^n \cong \mathbf{S}^n / \approx$, where \approx is the equivalence relation on \mathbf{S}^n which identifies antipodal points. \square

11.3.5 Example. The quotient space $I \times I / \sim$, where \sim is the equivalence relation $(0, t) \sim (1, t)$ and $(t, 0) \sim (1 - t, 1)$, is called the **Klein bottle**², denoted by \mathbb{K} .

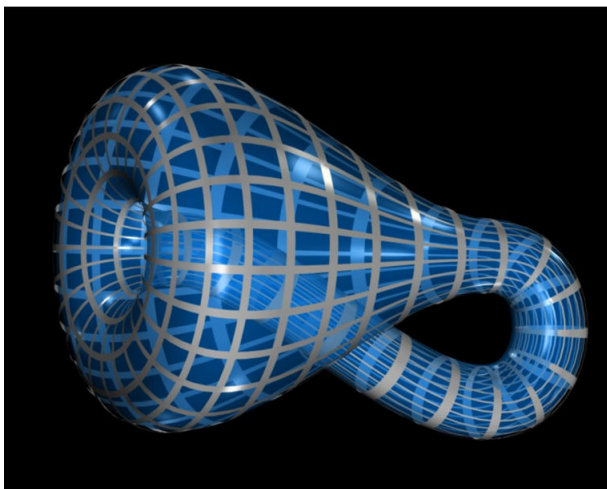
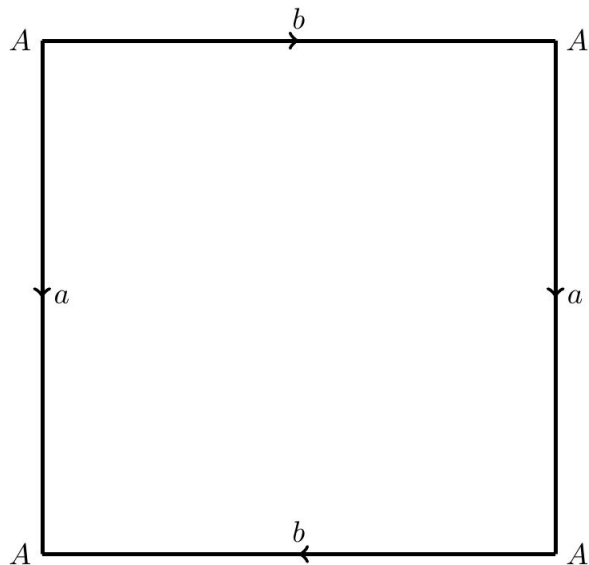

Klein bottle by Thomas Banchoff

Like the real projective plane in [Examples 11.3.4](#), the Klein bottle cannot be embedded in 3-dimensional euclidean space (without crossing itself), but it can be embedded in \mathbb{R}^4 . When embedded in \mathbb{R}^4 , like the Möbius strip, it is one-sided. \square

Exercises 11.3

1. Verify that the Möbius strip is a compact Hausdorff subspace of \mathbb{R}^3 with boundary homeomorphic to a circle.

²The [beautiful representation on this page of the Klein bottle](#) in 3-dimensions was produced by Professor Thomas F. Banchoff, a geometer, of Brown University, Providence, Rhode Island, USA.

2. The diagram below represents the quotient space $I \times I / \sim$. Write down the equivalence relation \sim and then verify that the diagram represents a torus. Deduce that the torus is a compact Hausdorff topological space.

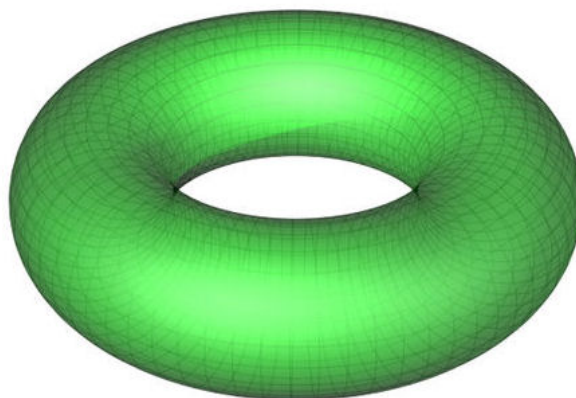
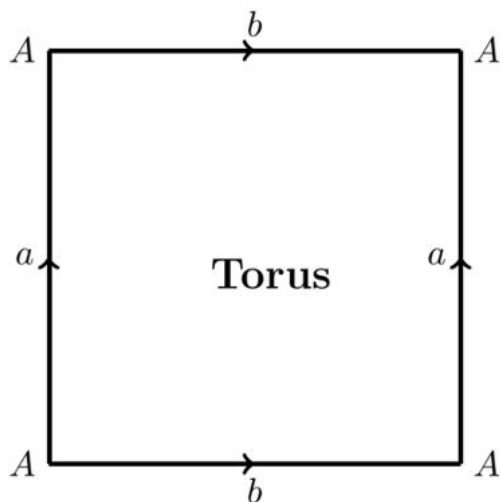

3. Verify that the boundary of the Klein bottle in \mathbb{R}^4 is the empty set.

11.4 Postscript

In this chapter we introduced the important notions of quotient space and its associated quotient mapping or identification mapping. We noted that every continuous mapping of a compact space onto a Hausdorff space is a quotient mapping. Quotients were used to produce new and interesting spaces including cylinders, cones, the Klein bottle, real projective spaces and the Möbius strip. We introduced the cone and suspension which are of relevance to study in algebraic topology. In the final section we showed how to use polygonal representations to define figures such as the Klein bottle which cannot be embedded in 3-dimensional euclidean space.

This short chapter is but the smallest taste of what awaits you in further study of topology.

11.5 Credit for Images

1. Klein Bottle.

Dear Professor Morris,

You have my permission to use our Klein bottle in your freely available online book "Topology Without Tears". The parametrization was due to me and the particularly nice rendering was produced by a student, Jeff Beall. Of all the images that have come from our work, this is the one most requested for reproduction. Tom Banchoff, Professor Emeritus Brown University (as of 2014)
August 8, 2017.

Chapter 12

The Stone-Weierstrass Theorem

Introduction

Section 1 is devoted to the Weierstrass Theorem, proved by Karl Weierstrass (1815–1897) in 1885 when he was aged 70. It is a very powerful theorem, with very many applications even to this day. Over the next 30 years there was a variety of proofs by famous mathematicians. In 1964 Kuhn [245], gave an elementary proof using the Bernoulli inequality (named after Jacob Bernoulli (1655–1705)).

In Section 1 we give a quite elementary¹ proof using the Bernoulli inequality. The proof we present here is primarily due to my teacher, Rudolf Výborný in his paper Výborný [414] but is also influenced by the presentation of Păltineanu [333] which was also influenced by Výborný [414].

In Section 2, we prove the generalization of the Weierstrass Theorem first proved in 1937 by Marshall Harvey Stone (1903–1989), Stone [384], and with a simpler proof in 1948, Stone [385]. This elegant generalization is known as the Stone-Weierstrass Theorem.

The beautiful Stone-Weierstrass Theorem is a theorem in Pure Mathematics but has very important applications.

¹Readers should understand that elementary does not mean easy. Rather it means that it uses only elementary mathematics.



Weierstrass



Stone



Bernoulli



Výborný

12.1 The Weierstrass Approximation Theorem

We begin by stating and proving the Bernoulli inequality which was named after the Swiss mathematician Jacob Bernoulli (1654–1705).

12.1.1 Proposition. Let $x \in \mathbb{R}$ such that $x \geq -1$, and $n \in \mathbb{N}$. Then

$$(1 + x)^n \geq 1 + nx.$$

Proof. This is proved using mathematical induction.

Clearly it is true if $n = 1$.

Assume that for some integer k , $(1 + x)^k \geq 1 + kx$, for all $x \geq -1$.

$$\begin{aligned} \text{Then } (1 + x)^{k+1} &= (1 + x)^k \cdot (1 + x) \\ &\geq (1 + kx) \cdot (1 + x), && \text{by the inductive assumption} \\ &= 1 + kx + kx + kx^2 \\ &\geq 1 + kx + kx \\ &= 1 + (k + 1)x, && \text{as required.} \end{aligned}$$

So if the Bernoulli inequality is true for $n = k$, then it is true for $n = k + 1$. Thus by mathematical induction, the Bernoulli inequality is true for all $n \in \mathbb{N}$. \square

We shall prove the Weierstrass Theorem on Polynomial Approximation.

The Weierstrass Approximation Theorem. If $f : [a, b] \rightarrow \mathbb{C}$ is a continuous function and ε is a positive real number, then there exists a polynomial P such that $|f(x) - P(x)| < \varepsilon$, for all $x \in [a, b]$.

If you think about this, you can see that it is quite surprising. It says that no matter how strange a continuous function may be, it can be approximated as close as we like by a very nice simple function, namely a polynomial². Not only is this result quite surprising, it is very useful in practical applications.

We shall prove the Weierstrass Approximation Theorem with \mathbb{C} replaced by \mathbb{R} , from which the Theorem easily follows. The main idea of the proof is to show that if f can be approximated by a polynomial on some interval, then it can be approximated by a polynomial on a slightly larger interval. To show this we shall use the following lemma.

First we mention a definition:

12.1.2 Definition. Let $a_n \in \mathbb{C}$ and $b \in \mathbb{C}$, for each $n \in \mathbb{N}$. If for each $\varepsilon > 0$, there exists an $N_\varepsilon \in \mathbb{N}$ such that $|a_n - b| < \varepsilon$, for $n \geq N_\varepsilon$, then the sequence of complex numbers a_n is said to have b as its limit. This is denoted by $\lim_{n \rightarrow \infty} a_n = b$ or equivalently $a_n \rightarrow b$.

²Even if the function f is continuous but nowhere differentiable, it can be approximated by an infinitely differentiable function, namely a polynomial. This remarkable result is not to be confused with Taylor polynomials or Taylor series which require f to be not just differentiable but infinitely differentiable. See [Exercises 10.3 #28\(vii\)](#).

12.1.3 Lemma. Let X be an arbitrary set, U a function mapping X into \mathbb{R} such that $0 < U(x) < 1$, for all $x \in X$. Let A and B be disjoint subsets of X . If there exists a $k \in \mathbb{N}$ such that $U(x) < \frac{1}{k}$, for all $x \in A$ and $U(x) > \frac{1}{k}$, for all $x \in B$, then

$$\begin{aligned} \lim_{n \rightarrow \infty} (1 - [U(x)]^n)^{k^n} &= 1, \text{ for all } x \in A, \text{ and} \\ \lim_{n \rightarrow \infty} (1 - [U(x)]^n)^{k^n} &= 0, \text{ for all } x \in B. \end{aligned}$$

Proof.

$$\begin{aligned} 1 &\geq 1 - [U(x)]^n)^{k^n} \geq 1 - k^n [U(x)]^n, \text{ by Proposition 12.1.1} \\ &= 1 - [kU(x)]^n \\ &\rightarrow 1, \text{ for } x \in A. \end{aligned}$$

$$\begin{aligned} 0 &\leq 1 - [U(x)]^n)^{k^n} = \frac{(1 - [U(x)]^n)^{k^n} [kU(x)]^n}{[kU(x)]^n} \\ &< \frac{(1 - [U(x)]^n)^{k^n}}{[kU(x)]^n} (1 + k^n [U(x)]^n) \\ &\leq \frac{(1 - [U(x)]^n)^{k^n} (1 + [U(x)]^n)^{k^n}}{[kU(x)]^n}, \text{ by Proposition 12.1.1} \\ &= \frac{(1 - [U(x)]^{2n})^{k^n}}{[kU(x)]^n} \\ &< \frac{1}{[kU(x)]^n} \\ &\rightarrow 0, \text{ for } x \in B. \end{aligned}$$

□

12.1.4 Lemma. Let $a, b, c, d \in \mathbb{R}$ with $a < d < c < b$ and let η be any positive real number. Then for each $n \in \mathbb{N}$, there exists a polynomial p_n such that

$$0 \leq p_n(x) \leq 1, \quad \text{for } x \in [a, b]; \quad (1)$$

$$1 - \eta \leq p_n(x), \quad \text{for } x \in [a, d]; \quad (2)$$

$$p_n(x) \leq \eta, \quad \text{for } x \in [c, b]; \quad (3)$$

$$\lim_{n \rightarrow \infty} p_n(x) = 1, \quad \text{for } x \in [a, d]; \quad (4)$$

$$\lim_{n \rightarrow \infty} p_n(x) = 0, \quad \text{for } x \in [c, b]. \quad (5)$$

Proof.

Here is an example

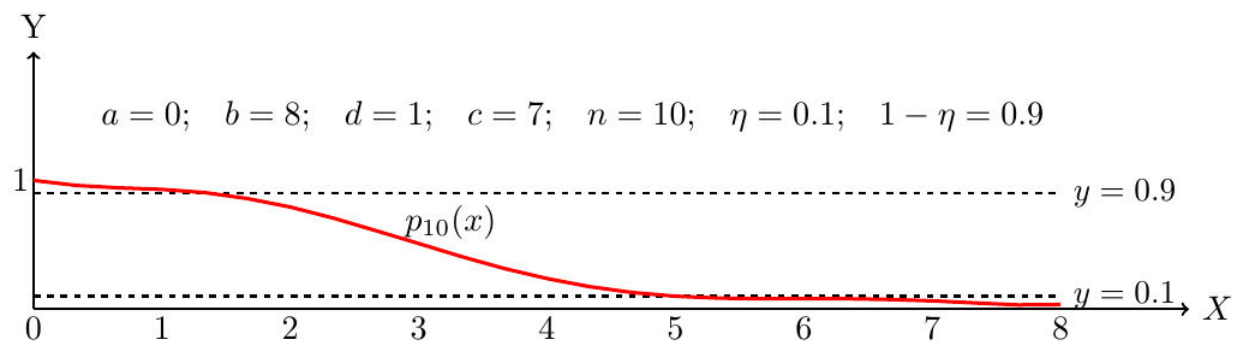

Let

$$e = \frac{c + d}{2}, \quad \text{and}$$

$$U(x) = \frac{1}{2} + \frac{x - e}{2(b - a)}, \quad \text{for all } x \in [a, b].$$

Noting that $a < d < e < c < b$ we have

$$\begin{aligned}
 U(a) &= \frac{1}{2} + \frac{a - e}{2(b - a)} > 0; \\
 U(d) &= \frac{1}{2} + \frac{d - e}{2(b - a)} < \frac{1}{2}; \\
 U(c) &= \frac{1}{2} + \frac{c - e}{2(b - a)} > \frac{1}{2}; \\
 U(b) &= \frac{1}{2} + \frac{b - e}{2(b - a)} \\
 &= \frac{1}{2} + \frac{b - a}{2(b - a)} + \frac{a - e}{2(b - a)} \\
 &= 1 + \frac{a - e}{2(b - a)} \\
 &< 1.
 \end{aligned}$$

From its definition we see that U is an increasing function and it then follows from the above inequalities that

$$\begin{aligned}
 0 < U(x) < 1, \quad x \in [a, b] \\
 U(x) < \frac{1}{2}, \quad x \in [a, d] \\
 U(x) > \frac{1}{2}, \quad x \in [c, b]
 \end{aligned}$$

Define the polynomial p_n , for each $n \in \mathbb{N}$, by $p_n(x) = (1 - [U(x)]^n)^{2^n}$, for all $x \in [a, b]$.

Clearly we have $0 \leq p_n(x) \leq 1$, for all $x \in [a, b]$ which proves (1) in the statement of the Lemma.

Applying [Lemma 12.1.3](#) for $k = 2$, $A = [a, d]$, and $B = [c, b]$, we have that

$$\begin{aligned}
 \lim_{n \rightarrow \infty} p_n(x) &= 1, \quad \text{for } x \in [a, c]; \\
 \lim_{n \rightarrow \infty} p_n(x) &= 0, \quad \text{for } x \in [d, b],
 \end{aligned}$$

which proves (4) and (5) in the statement of the Lemma.

By (4) there exists $n_1 \in \mathbb{N}$ such that $p_{n_1}(x) > 1 - \eta$, for all $x \in [a, d]$ and by (5) there exists $n_2 \in \mathbb{N}$ such that $p_{n_2}(x) < \eta$, for all $x \in [c, b]$. Putting n equal to the greater of n_1 and n_2 , we have that (4) and (5) imply (2) and (3), which completes the proof of the Lemma. \square

12.1.5 Theorem. [The Weierstrass Approximation Theorem]

If $f : [a, b] \rightarrow \mathbb{C}$ is a continuous function and ε is a positive real number, then there exists a polynomial P such that

$$|f(x) - P(x)| < \varepsilon, \text{ for all } x \in [a, b]. \quad (6)$$

Proof. Let $g(x) = \Re(f(x))$ and $h(x) = \Im(f(x))$ the real and imaginary parts of $f(x)$ respectively, for $x \in [a, b]$, so that g and h are continuous functions from $[a, b]$ into \mathbb{R} .

If there exist polynomials P_g and P_h such that for all $x \in [a, b]$, $|g(x) - P_g(x)| < \frac{\varepsilon}{2}$ and $|h(x) - P_h(x)| < \frac{\varepsilon}{2}$, then putting $P(x) = P_g(x) + iP_h(x)$ we have that the polynomial P satisfies $|f(x) - P(x)| < \varepsilon$.

So to prove this theorem, it suffices to prove it for the special case:

f is a continuous function of $[a, b]$ into \mathbb{R} .

We shall now assume, without loss of generality, that f is indeed a continuous function of $[a, b]$ into \mathbb{R} .

For the given $\varepsilon > 0$, let S_ε be the set of all $t \leq b$ such that there exists a polynomial P_ε with the property that

$$|f(x) - P_\varepsilon(x)| < \varepsilon, \text{ for all } x \in [a, t]. \quad (7)$$

We need to show S_ε is not the empty set.

By continuity of f , there exists $t_0 > a$ such that

$$|f(x) - f(a)| < \varepsilon, \text{ for all } x \in [a, t_0]. \quad (8)$$

Consequently, f can be approximated by the constant function $f(x) = f(a)$ on $[a, t_0]$, so $S_\varepsilon \neq \emptyset$.

Let $s = \sup S_\varepsilon$. Clearly $a < s \leq b$.

The proof of the Theorem will be complete if we can prove that $s = b$.

By continuity of f at s , there is a $\delta > 0$ such that

$$|f(x) - f(s)| \leq \frac{\varepsilon}{3}, \text{ for } s - \delta \leq x \leq s + \delta \text{ and } a \leq x \leq b. \quad (9)$$

By the definition of supremum, there is a c with $s - \delta \leq c \leq s$ and $c \in S_\varepsilon$. This means that there is a polynomial P_ε satisfying (7) for $x \in [a, c]$. Let

$$m = \max\{|f(x) - P_\varepsilon(x)| : a \leq x \leq c\}.$$

$$\text{So } m < \varepsilon. \quad (10)$$

Recall [Proposition 7.2.15](#) says that if ϕ is a continuous function from $[a, b]$ into \mathbb{R} , then $\phi([a, b]) = [v, w]$, for some $v, w \in \mathbb{R}$.

As the function f and the polynomial P_ε are continuous on $[a, b]$, the function ϕ defined by $\phi(x) = |f(x) - P_\varepsilon(x)| + |f(x) - f(s)|$ is continuous on $[a, b]$. So $\phi([a, b]) = [v, w]$, for some $v, w \in \mathbb{R}$. Therefore we can choose $M \in \mathbb{R}$ such that

$$M > |f(x) - P_\varepsilon(x)| + |f(x) - f(s)|, \text{ for all } x \in [a, b] \quad (11).$$

We shall apply [Lemma 12.1.4](#) for $d = s - \delta$. Noting that, by (10), $m < \varepsilon$, choose $0 < \eta < 1$ so small that

$$m + M\eta < \varepsilon \quad \text{and} \quad M\eta < \frac{2\varepsilon}{3}. \quad (12)$$

Apply [Lemma 12.1.4](#) to find a polynomial p_n satisfying (1), (2) and (3).

Now we define the required polynomial P by

$$P(x) = f(s) + |P_\varepsilon(x) - f(s)|p_n(x). \quad (13)$$

and we shall show that it satisfies condition (6) of the statement of the Theorem.

First we have

$$\begin{aligned}
 |f(x) - P(x)| &= |f(x) - f(s) - [P_\varepsilon(x) - f(s)]p_n(x)| \\
 &= |[f(x) - P_\varepsilon(x)]p_n(x) + [f(x) - f(s)](1 - p_n(x))| \\
 &= |[f(x) - P_\varepsilon(x)]p_n(x) + [(f(x) - f(s))(1 - p_n(x))]| \\
 &\leq |f(x) - P_\varepsilon(x)|p_n(x) + |f(x) - f(s)|(1 - p_n(x)) \tag{14}
 \end{aligned}$$

On the interval $[a, s - \delta]$

$$\begin{aligned}
 &|f(x) - P(x)| \\
 &\leq [|f(x) - P_\varepsilon(x)| - |f(x) - P_\varepsilon(x)|(1 - p_n(x))] + |f(x) - f(s)|(1 - p_n(x)), \text{ by (14)} \\
 &\leq |f(x) - P_\varepsilon(x)| + [|f(x) - P_\varepsilon(x)| + |f(x) - f(s)|](1 - p_n(x)) \\
 &\leq m + M\eta, \text{ by (10), (11) and (2) as } [a, s - \delta] \subseteq [a, c] \\
 &< \varepsilon, \text{ by (12)}. \tag{15}
 \end{aligned}$$

On the interval $[s - \delta, c]$

$$\begin{aligned}
 |f(x) - P(x)| &\leq |f(x) - P_\varepsilon(x)|p_n(x) + |f(x) - f(s)|(1 - p_n(x)), \text{ by (14)} \\
 &\leq \varepsilon p_n(x) + \frac{\varepsilon}{3}(1 - p_n(x)), \text{ by (10) and (9) noting that} \\
 &\qquad\qquad\qquad s - \delta \leq c \leq s \leq s + \delta \\
 &< \varepsilon, \text{ by (1)}. \tag{16}
 \end{aligned}$$

On the interval $[c, s + \delta] \cap [c, b]$ we have

$$\begin{aligned}
 |f(x) - P(x)| &\leq |f(x) - P_\varepsilon(x)|p_n(x) + |f(x) - f(s)|(1 - p_n(x)), \text{ by (14)} \\
 &\leq M p_n(x) + \frac{\varepsilon}{3}(1 - p_n(x)), \text{ by (11) and (9) as } s - \delta \leq c \leq s \leq b \\
 &< \frac{2\varepsilon}{3} + \frac{\varepsilon}{3}, \text{ by (2), (1), and the second part of (16)} \\
 &= \varepsilon, \text{ by (1)}. \tag{17}
 \end{aligned}$$

By (15),(16), and (17), we have

$$|f(x) - P(x)| < \varepsilon, \quad \text{for all } x \in [a, s + \delta] \cap [c, b]. \tag{18}$$

Suppose $s < b$. Then (18) contradicts the definition of s as the supremum of the set S_ε . So $s = b$; that is, $[a, s] = [a, b]$, which completes the proof of the Theorem. \square

12.1.6 Remark. In the literature there are many somewhat different proofs of the [Weierstrass Approximation Theorem 12.1.5](#). Our proof above, uses proof by contradiction which is avoided in the constructive proof using Bernstein Polynomials, discovered in 1912 by the Russian mathematician Sergei Natanovich Bernstein (1880–1968), and which is motivated by probability theory. Bernstein [39] proved that for any continuous function $f : [0, 1] \rightarrow \mathbb{R}$, f can be expressed as an infinite sum of polynomials:



Bernstein

$$f(x) = \lim_{n \rightarrow \infty} \sum_{m=0}^n f\left(\frac{m}{n}\right) \binom{n}{m} x^m (1-x)^{n-m},$$

and so f can be approximated as closely as we like by the partial sum from $m = 0$ to $m = n$. For each $n \in \mathbb{N}$, the polynomial $B_n(f) = \sum_{m=0}^n f\left(\frac{m}{n}\right) \binom{n}{m} x^m (1-x)^{n-m}$ is called the **Bernstein polynomial of degree n associated with f** . (See Bernstein basis polynomials in [Exercises 10.3 #28](#).) So **Bernstein polynomials provide a very concrete and practical method of approximating continuous functions**. We will see this is extremely useful in [Remark 12.1.7](#).

Noting that for any $a_0, a_1, a_2, \dots, a_n \in \mathbb{R}$, there exists a continuous function $f : [0, 1] \rightarrow \mathbb{R}$ with $f\left(\frac{m}{n}\right) = a_m$, $m = 0, 1, 2, \dots, n$ ([Exercises 12.1 #5](#)) we see that every polynomial $\sum_{m=0}^n a_m \binom{n}{m} x^m (1-x)^{n-m}$ is the Bernstein polynomial of degree n associated with some continuous function $f : [0, 1] \rightarrow \mathbb{R}$. But, noting [Exercises 10.3 #28 \(ix\)](#), we see that every polynomial can be written in this form. So **every polynomial is the Bernstein polynomial associated with some continuous function $f : [0, 1] \rightarrow \mathbb{R}$** . \square

12.1.7 Remark. It is worth mentioning that Bernstein polynomials are at the heart of what are known as Bézier curves used in graphics. They were developed by the French mathematician Paul de Casteljaou (1930–) at Citroën and the French engineer Pierre Bézier (1910–1999) at Renault who used them to design car bodies. Today this mathematics is at the core of computer graphics and CAD/CAM (computer-aided-design/computer-aided manufacturing). Quoting from “The first years of CAD/CAM and the UNISURF CAD System” by Pierre Bézier, in Piegl [325]: In the words of Pierre Bézier himself: There is no doubt that Citroën was the first company in France that paid attention to CAD, as early as 1958. Paul de Casteljaou, a highly gifted mathematician, devised a system based on the use of Bernstein polynomials ... the system devised by de Casteljaou was oriented towards translating already existing shapes into patches, defined in terms of numerical data. ...

Due to Citroën’s policy, the results obtained by de Casteljaou were not published until 1974, and this excellent mathematician was deprived of part of the well deserved fame that his discoveries and inventions should have earned him. \square

We can deduce a stronger version of [The Weierstrass Approximation Theorem 12.1.6](#) as a corollary of the theorem itself. If P is such that $P(x) = a_0 + a_1x + \dots + a_nx^n$, where each $a_j = r_j + is_j$, where a_j and b_j are rational (real) numbers for $j \in \{1, 2, \dots, n\}$, then the polynomial P is said to have **rational number coefficients**.

12.1.8 Corollary. If $f : [a, b] \rightarrow \mathbb{C}$ is a continuous function and ε is a positive real number, then there exists a polynomial P with rational number coefficients such that $|f(x) - P(x)| < \varepsilon$, for all $x \in [a, b]$.

Proof. Exercise. \square



Casteljaou



Bezier

12.1.9 Proposition. Let $C[0, 1]$ be the set of all continuous functions of $[0, 1]$ into \mathbb{R} . If \mathcal{T} is the topology on $C[0, 1]$ induced by the supremum metric in [Example 6.1.6](#), then

- (i) the set of all polynomials is dense in $(C[0, 1], \mathcal{T})$;
- (ii) the set of all polynomials with rational number coefficients is dense in $(C[0, 1], \mathcal{T})$;
- (iii) $(C[0, 1], \mathcal{T})$ is a separable space; and
- (iv) the cardinality of $C[0, 1]$ is 2^{\aleph_0} .

Proof. Exercise. □

To make the proof of [The Weierstrass Approximation Theorem 12.1.5](#) as elementary as we could, we avoided any mention of uniform convergence. But we do mention it now before completing this section.

12.1.10 Definition. Let S be any subset of \mathbb{R} and p_n , $n \in \mathbb{N}$, a sequence of functions $S \rightarrow \mathbb{C}$. Then p_n , $n \in \mathbb{N}$ is said to be **pointwise convergent** to a function $f : S \rightarrow \mathbb{C}$ if given any $x \in S$ and any $\varepsilon > 0$, there exists $N(x, \varepsilon) \in \mathbb{N}$ such that

$$|f(x) - p_n(x)| < \varepsilon, \text{ for every } n \in \mathbb{N} \text{ such that } n > N(x, \varepsilon).$$

Note that the notation $N(x, \varepsilon)$ means that this number depends on both x and ε . Contrast this definition with the next one.

12.1.11 Definition. Let S be any subset of \mathbb{R} and p_n , $n \in \mathbb{N}$, a sequence of functions $S \rightarrow \mathbb{C}$. Then p_n , $n \in \mathbb{N}$, is said to be **uniformly convergent** to a function $f : S \rightarrow \mathbb{C}$ if given any $\varepsilon > 0$, there exists $N(\varepsilon) \in \mathbb{N}$ such that

$$|f(x) - p_n(x)| < \varepsilon, \text{ for every } x \in S \text{ and } n \in \mathbb{N} \text{ such that } n > N(\varepsilon).$$

12.1.12 Remark. Clearly uniform convergence of a sequence of functions implies pointwise convergence of that sequence. However, the converse is false. For example, it is easy to see that if $p_n(x) = \frac{nx}{1+n^2x^2}$, for all $x \in S = (0, \infty)$, then $p_n, n \in \mathbb{N}$, is pointwise convergent to the function $f(x) = 0$, for all $x \in (0, \infty)$. However, for every $0 < \varepsilon < \frac{1}{2}$, $|f(\frac{1}{n}) - p_n(\frac{1}{n})| = |0 - \frac{1}{2}| = \frac{1}{2} > \varepsilon$ and so $p_n, n \in \mathbb{N}$, is not uniformly convergent to f . Thus pointwise convergence does not imply uniform convergence. \square

12.1.13 Remark. We can now restate [The Weierstrass Approximation Theorem 12.1.5](#):

If $f : [a, b] \rightarrow \mathbb{C}$ is a continuous function, then there exists a sequence $p_n, n \in \mathbb{N}$, of polynomials on $[a, b]$ which is uniformly convergent to f . \square

12.1.14 Remark. Having seen in the [Weierstrass Approximation Theorem 12.1.5](#) that a continuous function can always be approximated by a polynomial, it is perhaps appropriate to underline the difference in behaviour of continuous functions and polynomials, indeed of (i) continuous functions, (ii) analytic functions (iii) C^∞ functions and (iv) polynomials. we begin with some definitions.

12.1.15 Definitions. Let U be an open subset of \mathbb{R} . A function $f : U \rightarrow \mathbb{R}$ is said to be **smooth** if it is infinitely differentiable at every point $x_0 \in U$. The function f is said to be **analytic at a point** $x_0 \in U$ if there exists an open neighbourhood $O \subseteq U$ of x_0 such that f is infinitely differentiable at every $x \in O$, and the Taylor series

$$T(x) = \sum_{n=0}^{\infty} \frac{f^{(n)}(x_0)}{n!} (x - x_0)^n$$

converges (pointwise) to $f(x)$ for all x in O , where $f^{(n)}(x_0)$ denotes the n^{th} derivative of f evaluated at x_0 . The function f is said to be **analytic on \mathbb{R}** if it is analytic at every $x_0 \in \mathbb{R}$.

The set of analytic functions on \mathbb{R} properly contains the set of all polynomials on \mathbb{R} , but is a proper subset of the set C^∞ of smooth (ie infinitely differentiable)

functions on \mathbb{R} . An example of a smooth function which is not analytic is given in Exercises 12.1 #10.

12.1.16 Theorem. Let f be a function of \mathbb{R} into itself and Z be the set of zeros of f ; that is, $Z = \{x : x \in \mathbb{R} \text{ such that } f(x) = 0\}$.

- (i) If f is a non-constant polynomial, then Z is a finite set.
- (ii) If f is a non-constant analytic function, then Z is a discrete subspace of \mathbb{R} .
- (iii) If Z is any closed subset of \mathbb{R} , then a C^∞ function f can be chosen with Z its set of zeros.

Proof. Exercise.

12.1.17 Remark. Having discussed differentiability of a function $f : \mathbb{R} \rightarrow \mathbb{R}$, we conclude this section by discussing differentiability³ of a function $f : \mathbb{R}^n \rightarrow \mathbb{R}^m$, a topic that is needed for the important study of differentiable manifolds.

Recall that a function $f : \mathbb{R} \rightarrow \mathbb{R}$ is said to be **differentiable at a point** $x_0 \in \mathbb{R}$ if there exists a number $f'(x_0) \in \mathbb{R}$ such that for $h \in \mathbb{R}$

$$\frac{f(x_0 + h) - f(x_0)}{h} \text{ converges to } f'(x_0) \text{ as } h \rightarrow 0.$$

We usually write this as

$$\lim_{h \rightarrow 0} \frac{f(x_0 + h) - f(x_0)}{h} = f'(x_0). \quad (1)$$

We reformulate this so that it can be generalized in a natural way to higher dimensional euclidean space.

If we define a linear transformation $\lambda : \mathbb{R} \rightarrow \mathbb{R}$ by $\lambda(h) = f'(x_0)h$, then equation (1) becomes

$$\lim_{h \rightarrow 0} \frac{f(x_0 + h) - (f(x_0) + \lambda(h))}{h} = 0. \quad (2)$$

³See Spivak [370].

12.1.18 Definition. Let U be an open subset of \mathbb{R}^n , $n \in \mathbb{N}$. A function $f : U \rightarrow \mathbb{R}^m$, $m \in \mathbb{N}$, is said to be **differentiable at a point** $x_0 \in U$, if there exists an open neighbourhood $O \subseteq U$ of x_0 such that for some linear transformation $\lambda : \mathbb{R}^n \rightarrow \mathbb{R}^m$

$$\lim_{h \rightarrow 0} \frac{|f(x_0 + h) - (f(x_0) + \lambda(h))|}{|h|} = 0$$

where $h \in \mathbb{R}^n$ and $|\cdot|$ denotes the euclidean norm both in \mathbb{R}^n and \mathbb{R}^m . The linear transformation λ is said to be the **derivative** of f at x_0 and is denoted by $Df(x_0)$.

12.1.19 Proposition. Let U be an open subset of \mathbb{R}^n , $n \in \mathbb{N}$. If $f : U \rightarrow \mathbb{R}^m$, $m \in \mathbb{N}$, is differentiable at $x_0 \in U$, then there is a unique linear transformation $\lambda : \mathbb{R}^n \rightarrow \mathbb{R}^m$ such that

$$\lim_{h \rightarrow 0} \frac{|f(x_0 + h) - (f(x_0) + \lambda(h))|}{|h|} = 0$$

Proof. Exercise.

At this stage, the unique linear transformation in Proposition 12.1.19 and Definition 12.1.18 is somewhat mysterious. We proceed to remove that mystery.

12.1.20 Definition. Let U be an open subset of \mathbb{R}^n , $n \in \mathbb{N}$. If $f : U \rightarrow \mathbb{R}$ and $r = (r_1, r_2, \dots, r_n) \in U$, the limit

$$\lim_{h \rightarrow 0} \frac{f(r_1, r_2, \dots, r_{i-1}, r_i + h, r_{i+1}, \dots, r_n) - f(r_1, r_2, \dots, r_n)}{h}$$

if it exists is said to be the i^{th} **partial derivative** of f at r and is denoted by $D_i f(r)$.

Of course if we put $g(x) = f(r_1, r_2, \dots, r_{i-1}, x, r_{i+1}, \dots, r_n)$, then $D_i f(r)$ equals $g'(r)$, the derivative of the function g at r_i .

12.1.21 Proposition. Let U be an open subset of \mathbb{R}^n , $n \in \mathbb{N}$, and $f : U \rightarrow \mathbb{R}^m$, $m \in \mathbb{N}$. Put $f = (f^1, f^2, \dots, f^m)$, where each $f^i : U \rightarrow \mathbb{R}$. If f is differentiable at $x_0 \in U$, then $D_j f^i(x_0)$ exists for $1 \leq i \leq m$, $1 \leq j \leq n$ and $f'(x_0)$ is the $m \times n$ matrix $(D_j f^i(x_0))$.

We now see that it is quite straightforward to calculate the derivative of a differentiable function mapping \mathbb{R}^n into \mathbb{R}^m . For a much more detailed discussion of the derivative of functions of several variables, see Spivak [370].

Exercises 12.1

1. Prove [Corollary 12.1.8](#).
2. Prove [Proposition 12.1.9](#).
3. Prove [Lemma 12.1.4](#) with η replaced by $\frac{1}{n}$.
[Hint. Be careful, as this is not as trivial as it first appears to be.]
4. Calculate the Bernstein polynomials $B_1(f)$ and $B_2(f)$ of each of the functions $f = f_1$, $f = f_2$, and $f = f_3$, where $f_1(x) = x$, $x \in [0, 1]$, $f_2(x) = x^2$, $x \in [0, 1]$, and $f_3(x) = x^3$, $x \in [0, 1]$, respectively.
5. Let $x_0, x_1, \dots, x_n \in [0, 1]$, with $x_0 < x_1 < \dots < x_n$, and let $a_0, a_1, \dots, a_n \in \mathbb{R}$. Show that there exists a continuous function $f : [0, 1] \rightarrow \mathbb{R}$ such that $f(x_i) = a_i$, for $i = 0, 1, \dots, n$.
6. Prove the following statement (Rudin [352], Theorem 7.8):
Let $p_n, n \in \mathbb{N}$, be a sequence of functions on a subset S of \mathbb{R} . The sequence $p_n, n \in \mathbb{N}$, is uniformly convergent to some function $f : S \rightarrow \mathbb{R}$ if and only if for each $\varepsilon > 0$, there exists $N \in \mathbb{N}$ such that

$$|p_m(x) - p_n(x)| < \varepsilon, \text{ for all } x \in S \text{ and } m, n \in \mathbb{N} \text{ with } m, n > N.$$

7. (i) Let S be a subset of \mathbb{R} and $p_n, n \in \mathbb{N}$, a sequence of continuous functions of S into \mathbb{C} . If the sequence $p_n, n \in \mathbb{N}$, is uniformly convergent to the function $f : S \rightarrow \mathbb{C}$, prove that f is a continuous function.
[Rudin [352], Theorem 7.12.]
- (ii) Let $C[0, 1]$ denote the normed vector space of all continuous functions $f : [0, 1] \rightarrow \mathbb{R}$, where $\|f\| = \sup_{x \in [0, 1]} |f(x)|$. Using (i) prove that $C[0, 1]$ is a Banach space.
- (iii) Let X be a compact Hausdorff space and F be \mathbb{R} or \mathbb{C} . Prove that the normed vector space $C(X, F)$ of all continuous functions $f : X \rightarrow F$ with the sup (or uniform) norm, given by $\|f\| = \sup_{x \in X} |f(x)|$, is a Banach space.

Dini's Theorem

8. **Dini's Theorem.** (Rudin [352], Theorem 7.13.) Let K be a subset of \mathbb{R} and $p_n, n \in \mathbb{N}$, a sequence of continuous functions mapping K into \mathbb{R} such that the sequence $p_n, n \in \mathbb{N}$, is pointwise convergent to a continuous function $f : K \rightarrow \mathbb{R}$. If (i) K is compact and (ii) $p_n(x) \geq p_{n+1}(x)$, for all $x \in K$, then the sequence $p_n, n \in \mathbb{N}$, is uniformly convergent to f .

[Dini's Theorem is named after the Italian mathematician Ulisse Dini (1845–1918).]



Dini

9. Verify Theorem 12.1.5 (i).

Support of a Function and Bump Functions

10. The **support** of a function $f : \mathbb{R} \rightarrow \mathbb{R}$ is $\{x : f(x) \neq 0\}$. A function $f : \mathbb{R} \rightarrow \mathbb{R}$ is said to be a **bump function** if it is smooth and its support is a compact subset of \mathbb{R} . Verify that the function $b : \mathbb{R} \rightarrow \mathbb{R}$ given by

$$b(x) = \begin{cases} \exp\left(-\frac{1}{1-x^2}\right) & \text{for } |x| < 1 \\ 0 & \text{for } |x| \geq 1 \end{cases}$$

is a bump function, and so is a smooth function, but is not an analytic function.

Uniformly Convergent Series

11. Let Z be any closed subset of \mathbb{R} . Verify the following:

(i) $\mathbb{R} \setminus Z$ is the union of open intervals U_i , $i \in I \subseteq \mathbb{N}$, where at most two of the U_i are unbounded.

(ii) For each $i \in I$, let b_i be a bump function on U_i such that if U_i is unbounded, then b_i is constant outside some bounded interval. (See [Exercise 10 above](#).) We can choose $c_i > 0$ such that $|c_i b_i^{(j)}(x)| < 2^{-i}$, for $0 \leq j \leq i$, for all $x \in \mathbb{R}$, where $b_i^{(j)}$ denotes the j^{th} derivative of the bump function b_i .

(iii) Define $f(x) = \sum_{i \in I} c_i f_i(x)$. Then each series $\sum_{i \in I} c_i f^{(j)}(x)$ converges absolutely and uniformly for all $x \in \mathbb{R}$.

[Recall that a series $\sum_{n=1}^{\infty} \theta_n(x)$, $x \in \mathbb{R}$, is said to be **uniformly convergent** if for every $\varepsilon > 0$, there exists an N , (N independent of x), such that for all $n \geq N$ and all $x \in \mathbb{R}$, $|s_n(x) - s(x)| < \varepsilon$, where $s_n(x) = \sum_{k=1}^n \theta_k(x)$ and $s(x) = \sum_{k=1}^{\infty} \theta_k(x)$.]

(iv) Then f is a smooth function.

(v) So [Theorem 12.1.16 \(iii\)](#) is true.

(vi) The function $f : \mathbb{R} \rightarrow \mathbb{R}$ is a smooth function but not an analytic function, where

$$f(x) = \begin{cases} e^{-\frac{1}{1-x^2}}, & \text{if } |x| < 1, \\ 0, & \text{otherwise.} \end{cases}$$

[Hint: Use [Theorem 12.1.16 \(ii\)](#).]

12. Let $f : \mathbb{R} \rightarrow \mathbb{R}$ be a non-constant function analytic on \mathbb{R} . Let $Z = \{x : f(x) = 0\}$. Assume that there exists an $x_0 \in \mathbb{R}$ such that $f(x_0) = 0$. As f is analytic, there exists an open neighbourhood O of x_0 such that

$$\sum_{n=0}^{\infty} \frac{f^{(n)}(x_0)}{n!} (x - x_0)^n \rightarrow f(x), \text{ for all } x \in O.$$

Putting $a_n = \frac{f^{(n)}(x_0)}{n!}$, this says

$$\sum_{n=0}^{\infty} a_n (x - x_0)^n \rightarrow f(x), \text{ for all } x \in O.$$

Since $f(x_0) = 0$, $a_0 = 0$. Without loss of generality, assume $a_0 = a_1 = \dots = a_k = 0$ and $a_{k+1} \neq 0$, where $k \geq 0$. So we can write the Taylor series for f about x_0 as

$$\sum_{n=k}^{\infty} a_n (x - x_0)^n = (x - x_0)^k \sum_{n=0}^{\infty} a_{n+k} (x - x_0)^n = (x - x_0)^k g(x)$$

where $g(x) = \sum_{n=0}^{\infty} a_{n+k} (x - x_0)^n$ and is analytic in the open neighbourhood O of x_0 . So g is a continuous function of O into \mathbb{R} . Since $g(x_0) = a_k \neq 0$, verify each of the following:

- (i) There exists an $\varepsilon > 0$ such that for $|x - x_0| < \varepsilon$, $|g(x) - a_k| < \frac{|a_k|}{2}$.
- (ii) $g(x) \neq 0$, for $|x - x_0| < \varepsilon$.
- (iii) $Z \cap (x_0 - \varepsilon, x_0 + \varepsilon) = \{x_0\}$.
- (iv) From (iii) above, Z is a discrete countable subspace of \mathbb{R} and so [Theorem 12.1.15\(ii\)](#) is true.

13. Prove [Proposition 12.1.19](#).
14. Prove that if $f : \mathbb{R}^n \rightarrow \mathbb{R}^m$, $n, m \in \mathbb{N}$, is a constant function (that is, for some $y \in \mathbb{R}^m$, $f(x) = y$ for all $x \in \mathbb{R}^n$), then $Df(x) = 0$, for all $x \in \mathbb{R}^n$.
15. Prove that if $f : \mathbb{R}^n \rightarrow \mathbb{R}^m$, $m, n \in \mathbb{N}$, is a linear transformation, then for each $x \in \mathbb{R}^n$, $Df(x) = f(x)$.

16. Prove that if $f, g : \mathbb{R}^n \rightarrow \mathbb{R}$, $n \in \mathbb{N}$, are differentiable at $x_0 \in \mathbb{R}^n$, then

$$D(f + g)(x_0) = Df(x_0) + Dg(x_0),$$

$$D(fg(x_0)) = g(x_0)Df(x_0) + f(x_0)Dg(x_0), \text{ and}$$

$$D(f/g)(x_0) = \frac{g(x_0)Df(x_0) - f(x_0)Dg(x_0)}{(g(x_0))^2}, \text{ for } g(x_0) \neq 0.$$

17. Find the partial derivatives of the following:

(i) $f(x, y, z) = x^y + z.$

(ii) $f(x, y, z) = \cos(xy) + \sin(z).$

18. Prove [Proposition 12.1.21](#).

19. Let $f : \mathbb{R}^n \rightarrow \mathbb{R}^m$, $m, n \in \mathbb{N}$. Define what it should mean that f is a smooth function and what it should mean that f is an analytic function.

12.2 The Stone-Weierstrass Theorem

In §1 we saw that the set of polynomials can be used to approximate any continuous function of $[0, 1]$ into \mathbb{R} , or put differently, the set of all polynomials is dense in $C([0, 1], \mathbb{R})$ with the supremum metric. We immediately saw generalizations of this, namely that the smaller set of all Bernstein polynomials is dense in $C([0, 1], \mathbb{R})$ as is the set of all polynomials with rational number coefficients. So we might ask: which subsets of $C([0, 1], \mathbb{R})$ are dense? But we shall see much more.

The Stone-Weierstrass Theorem addresses the more general problem of identifying the dense subsets of $C(X, \mathbb{R})$ and $C(X, \mathbb{C})$, where X is a compact Hausdorff space. The [Weierstrass Approximation Theorem 12.1.5](#) is a special case.

To address this problem we shall introduce some new concepts and definitions which are of importance in their own right. First, we make an insightful observation.

12.2.1 Definition. Let S be a set of functions from a set X into a set Y . Then S is said to **separate points** (of X) if for each $a, b \in X$ with $a \neq b$, there exists a $\phi \in S$ such that $\phi(a) \neq \phi(b)$.

12.2.2 Examples.

- (a) The set of all real-valued polynomials separates points of $[0, 1]$ as for any $a, b \in [0, 1]$ with $a \neq b$, the polynomial p given by $p(x) = x$, for all $x \in [0, 1]$ is such that $p(a) = a \neq b = p(b)$.
- (b) The set of all real-valued Bernstein polynomials separates points of $[0, 1]$ as for any $a, b \in [0, 1]$ with $a \neq b$, the Bernstein polynomial $B_1(f)$, where $f(x) = x$, for all $x \in [0, 1]$, is readily seen to satisfy $B_1(f) = f$. So $(B_1(f))(a) \neq (B_1(f))(b)$.
- (c) On the other hand, the set $\{f_n : f_n(x) = \sin(2\pi nx), x \in [0, 1], n \in \mathbb{N}\}$ of functions of $[0, 1]$ into \mathbb{R} does not separate the points 0 and 1, since

$$f_n(0) = \sin(0) = 0 = \sin(2\pi n) = f_n(1), \text{ for all } n \in \mathbb{N}. \quad \square$$

Our next proposition gives us a necessary (but not sufficient) condition for a subset S of $C[0, 1]$ to be dense, namely that it separates points of $[0, 1]$. Indeed it provides a necessary condition for a subset S of $C(X, F)$ to be dense, for F equal to \mathbb{R} or \mathbb{C} , and X a compact Hausdorff space.

12.2.3 Proposition. Let (X, \mathcal{T}) be a compact Hausdorff space, F equal to \mathbb{R} or \mathbb{C} , and S a subset of $C(X, F)$, the set of all continuous function of (X, \mathcal{T}) into F with the topology induced by the supremum metric. If S is dense in $C(X, F)$, then S separates points of X .

Proof. Suppose S does not separate points of X . Then there exist $a, b \in X$ with $a \neq b$ such that $\phi(a) = \phi(b)$, for all $\phi \in S$. As S is dense in $C(X, F)$, for each $\varepsilon > 0$ and each $f \in C(X, F)$, there exists a $\phi \in S$ such that

$$\sup_{x \in X} |f(x) - \phi(x)| < \varepsilon.$$

As X is compact Hausdorff, there is a continuous function $f \in C(X, F)$ such that $f(a) = 0$ and $f(b) = 1$, and put $\varepsilon = \frac{1}{3}$. So we have

$$|f(a) - \phi(a)| < \varepsilon = \frac{1}{3}, \quad (19)$$

$$\text{and } |f(b) - \phi(b)| < \varepsilon = \frac{1}{3}. \quad (20)$$

$$\begin{aligned} \text{Now } 1 &= |f(b) - f(a)| = |(f(b) - \phi(b)) + (\phi(b) - f(a))| \\ &= |(f(b) - \phi(b)) + (\phi(a) - f(a))|, \text{ as } \phi(a) = \phi(b) \\ &\leq |f(b) - \phi(b)| + |\phi(a) - f(a)| \\ &< \frac{2}{3}, \text{ by (19) and (20).} \end{aligned}$$

As it is not true that $1 < \frac{2}{3}$, we have a contradiction and so our supposition that S does not separate points of $C(X, F)$ is false, which completes the proof of the proposition. \square

We now define the notion of an algebra over F , where $F = \mathbb{R}$ or $F = \mathbb{C}$. It is roughly speaking a vector space with a multiplication of vectors. So an algebra is a set together with operations of addition, scalar multiplication, and multiplication.

12.2.4 Definitions. Let F be the field \mathbb{R} or \mathbb{C} . An **algebra** \mathcal{A} over F is a vector space over F together with a multiplication, that is a binary operation $\cdot : \mathcal{A} \times \mathcal{A} \rightarrow \mathcal{A}$ such that for any $x, y, z \in \mathcal{A}$ and $\alpha, \beta \in F$:

- (i) $(x + y) \cdot z = x \cdot y + x \cdot z$;
- (ii) $x \cdot (y + z) = x \cdot y + x \cdot z$; and
- (iii) $(\alpha x) \cdot (\beta y) = (\alpha\beta)(x \cdot y)$.

The algebra \mathcal{A} is said to be a **unital algebra** over F if there exists an identity element $I \in \mathcal{A}$ such that $I \cdot x = x \cdot I = x$, for all $x \in \mathcal{A}$.

The algebra \mathcal{A} is said to be an **associative algebra** over F if $x \cdot (y \cdot z) = (x \cdot y) \cdot z$, for all $x, y, z \in \mathcal{A}$.

The algebra \mathcal{A} is said to be **commutative** if $x \cdot y = y \cdot x$, for all $x, y \in \mathcal{A}$.

12.2.5 Example. For each $n \in \mathbb{N}$, the set \mathcal{M}_n of all $n \times n$ matrices with real number entries is an algebra over \mathbb{R} , where the multiplication \cdot is matrix multiplication. This algebra is unital and associative but not commutative ([Exercises 12.2 #2](#)). □

12.2.6 Example. $C(X, \mathbb{R})$ is an algebra over the vector space \mathbb{R} if we define \cdot as follows: for $f, g \in C(X, \mathbb{R})$ and $\alpha \in \mathbb{R}$, $f + g$, αf , and $f \cdot g$ are given by

$$\begin{aligned}(f + g)(x) &= f(x) + g(x), \text{ for all } x \in \mathbb{R} \\ (\alpha f)(x) &= \alpha(f(x)), \text{ for all } x \in \mathbb{R} \\ (f \cdot g)(x) &= f(x)g(x), \text{ for all } x \in \mathbb{R}.\end{aligned}$$

Indeed $C(X, \mathbb{R})$ is a commutative associative unital algebra, where the identity I is the function $f(x) = 1$, for all $x \in \mathbb{R}$. □

12.2.7 Definition. Let S be a subset of an algebra \mathcal{A} . If S is itself an algebra with the operations of addition of vectors, scalar multiplication, and the binary operation \cdot of \mathcal{A} , then S is called a **subalgebra** of \mathcal{A} .

12.2.8 Example.

- (i) The set \mathcal{P} of all polynomials on $[0, 1]$ is a unital subalgebra of the algebra $(C[0, 1], \mathbb{R})$;
- (ii) The set of all Bernstein polynomials on $[0, 1]$ is a unital subalgebra of the algebra $(C[0, 1], \mathbb{R})$;
- (iii) Let \mathcal{A} be a subalgebra of $(C[0, 1], \mathbb{R})$ containing the identity function f_I and the constant function f_1 , where f_I is given by $f_I(x) = x$, for all $x \in [0, 1]$, and the constant function f_1 is given by $f_1(x) = 1$, for all $x \in [0, 1]$. Then \mathcal{A} contains \mathcal{P} [Exercise].
- (iv) It follows immediately from (iii) above and [Proposition 12.1.9 \(i\)](#) that the algebra \mathcal{A} in (iii) above is dense in $(C[0, 1], \mathbb{R})$. □

12.2.9 Definitions. Let \mathcal{A} be an associative algebra over F , where F is \mathbb{R} or \mathbb{C} . Let \mathcal{A} also be a normed vector space over F with norm $\| \cdot \|$. Then \mathcal{A} is a **normed algebra** if for all $x, y \in \mathcal{A}$, $\|x \cdot y\| \leq \|x\| \|y\|$.

If the norm $\| \cdot \|$ is also complete, that is \mathcal{A} is a Banach space, then the normed algebra is called a **Banach algebra**.

12.2.10 Remark. it is readily seen that if \mathcal{A} is a normed algebra, then the multiplication $\cdot : \mathcal{A} \times \mathcal{A} \rightarrow \mathcal{A}$ is a continuous mapping. □

12.2.11 Example. For any $n \in \mathbb{N}$, and F equal to \mathbb{R} or \mathbb{C} , F^n with the norm $\|x\| = |x|$, for all $x \in F$, is a Banach algebra if multiplication is given by $(x_1, x_2, \dots, x_n) \cdot (y_1, y_2, \dots, y_n) = (x_1 y_1, x_2 y_2, \dots, x_n y_n)$, for $(x_1, x_2, \dots, x_n), (y_1, y_2, \dots, y_n) \in F^n$. (Exercise). □

12.2.12 Proposition. Let X be a compact Hausdorff space and F equal to either \mathbb{C} or \mathbb{R} . Then $C(X, F)$ is a unital Banach algebra if for each $f \in C(X, F)$,

$$\|f\| = \sup_{x \in X} |f(x)|.$$

Proof. Exercise.

For completeness here, we repeat the definition of a partial order in a set which appeared in [Definitions 10.2.1](#) (See Davey and Priestley [97].)

12.2.13 Definition. A **partial order** on a set X is a binary relation, denoted by \leq , which has the properties:

- (i) $x \leq x$, for all $x \in X$ (**reflexive**)
- (ii) if $x \leq y$ and $y \leq x$, then $x = y$, for $x, y \in X$ (**antisymmetric**), and
- (iii) if $x \leq y$ and $y \leq z$, then $x \leq z$, for $x, y, z \in X$ (**transitive**)

The set X equipped with the partial order \leq is called a **partially ordered set** and denoted by (X, \leq) . If $x \leq y$ and $x \neq y$, then we write $x < y$.

12.2.14 Definitions. Let X be a non-empty partially ordered set and let $S \subseteq X$. An element $u \in X$ is said to be an **upper bound** of S if $s \leq u$, for every $s \in S$.

The element $l \in X$ is said to be a **lower bound** of S if $l \leq s$, for every $s \in S$.

If the element $x \in X$ is an upper bound of S and is such that $x \leq u$ for each upper bound u of S , then x is said to be the **least upper bound** of S .

If the element $x \in X$ is a lower bound of S and is such that $l \leq x$ for each lower bound l of S , then x is said to be the **greatest lower bound** of S .

Let $x, y \in X$ and put $S = \{x, y\}$. If the least upper bound of S exists, then it is denoted by $x \vee y$.

Let $x, y \in X$ and put $S = \{x, y\}$. If the greatest lower bound of S exists, then it is denoted by $x \wedge y$.

If $x \vee y$ and $x \wedge y$ exist for all $x, y \in X$, then X is said to be a **lattice**.

Let L be a lattice with partial order \leq . If S is a subset of L , then S is said to be a **sublattice** of L if S with the partial order \leq is also a lattice.

12.2.15 Example. Let X be any compact Hausdorff space and $f, g \in C(X, \mathbb{R})$. Then $C(X, \mathbb{R})$ is a partially ordered set if $f \leq g$ is defined to mean $f(x) \leq g(x)$, for each $x \in X$. Indeed, noting that

$$\begin{aligned}(f \vee g)(x) &= \max\{f(x), g(x)\} \\ (f \wedge g)(x) &= \min\{f(x), g(x)\},\end{aligned}$$

we see that $C(X, \mathbb{R})$ is a lattice. □

12.2.16 Remark. We now begin our proof of the Stone-Weierstrass Theorem in earnest. The proof follows that in Simmons [362]. The first step is to prove a version of the Stone-Weierstrass Theorem for certain sublattices of $C(X, \mathbb{R})$. Then we use the [Weierstrass Approximation Theorem 12.1.5](#) to prove that any closed subalgebra of $C(X, \mathbb{R})$ is a sublattice of $C(X, \mathbb{R})$. Then it is easy to prove the Stone-Weierstrass Theorem for $C(X, \mathbb{R})$. Finally we prove the Stone-Weierstrass Theorem for $C(X, \mathbb{C})$. \square

12.2.17 Proposition. Let X be a compact Hausdorff space with more than one point and let L be a closed sublattice of $C(X, \mathbb{R})$. If L has the property that for any $x, y \in X$ with $x \neq y$ and any $a, b \in \mathbb{R}$, there exists $\phi \in L$ such that $\phi(x) = a$ and $\phi(y) = b$, then $L = C(X, \mathbb{R})$.

Proof. Let $f \in C(X, \mathbb{R})$. We need to show that $f \in L$.

Let $\varepsilon > 0$ be given. Since L is closed in $C(X, \mathbb{R})$, it suffices to find a function $g \in L$ such that $|f(x) - g(x)| < \varepsilon$, for all $x \in X$, as this implies that

$$\|f - g\| = \sup\{|f(x) - g(x)| : x \in X\} < \varepsilon$$

and so L is dense (and closed) in $C(X, \mathbb{R})$.

Fix a point $x \in X$ and let $y \in X$, $y \neq x$. By our assumption on L , there exists a function $\phi_y \in L$ such that $\phi_y(x) = f(x)$ and $\phi_y(y) = f(y)$. Let O_y be the open set given by $O_y = \{t : t \in X, \phi_y(t) < f(t) + \varepsilon\}$. Clearly $x, y \in O_y$. So $\{O_y : y \in X\}$ is an open covering of the compact space X . So there is a finite subcover O_1, O_2, \dots, O_n of X . If the corresponding functions in L are denoted by $\phi_1, \phi_2, \dots, \phi_n$, the function

$$\Phi_x = \phi_1 \wedge \phi_2 \wedge \dots \wedge \phi_n \in L$$

and $\Phi_x(x) = f(x)$ and $\Phi_x(t) < f(t) + \varepsilon$, for all $t \in X$.

For each $x \in X$, define the open set $U_x = \{t : t \in X, \Phi_x(t) > f(t) - \varepsilon\}$. Since $x \in U_x$, the sets U_x , $x \in X$ are an open covering of the compact space X . So there is a finite subcover U_1, U_2, \dots, U_m of X . We denote the corresponding functions in L by $\Phi_1, \Phi_2, \dots, \Phi_m$. Define a function $g \in L$ by

$$g = \Phi_1 \vee \Phi_2 \vee \dots \vee \Phi_m.$$

It is clear that $f(t) - \varepsilon < g(t) < f(t) + \varepsilon$, for all $t \in X$, which completes our proof. \square

12.2.18 Lemma. Let X be any compact Hausdorff space, $f \in C(X, \mathbb{R})$ and $|f|$ defined by $|f|(x) = |f(x)|$, for every $x \in X$.

- (i) $|f| \in C(X, \mathbb{R})$;
- (ii) $f \wedge g = \frac{1}{2}(f + g - |f - g|)$, for all $f, g \in C(X, \mathbb{R})$;
- (iii) $f \vee g = \frac{1}{2}(f + g + |f - g|)$, for all $f, g \in C(X, \mathbb{R})$;
- (iv) let \mathcal{A} be any vector subspace of $C(X, \mathbb{R})$ with the property that $f \in \mathcal{A} \implies |f| \in \mathcal{A}$. Then \mathcal{A} is a sublattice of $C(X, \mathbb{R})$.

Proof. Exercise \square

12.2.19 Proposition. Let X be a compact Hausdorff space. Then every closed subalgebra of $C(X, \mathbb{R})$ is a closed sublattice of $C(X, \mathbb{R})$.

Proof. Let \mathcal{A} be a closed subalgebra of $C(X, \mathbb{R})$. If $f, g \in C(X, \mathbb{R})$. By [Lemma 7.2.18 \(iv\)](#) it suffices to show that $f \in \mathcal{A} \implies |f| \in \mathcal{A}$.

Let $\varepsilon > 0$ be given. For any $f \in C(X, \mathbb{R})$, define the the closed interval $[a, b] \subset \mathbb{R}$, where $a = -\|f\|$ and $b = \|f\|$. The function $\phi_t : [a, b] \rightarrow \mathbb{R}$ given by $\phi_t = |t|$, for $t \in [a, b]$ is a continuous function. from $[a, b]$ into \mathbb{R} . So by the [Weierstrass Theorem 12.1.5](#), there exists a polynomial p' such that $||t| - p'(t)| < \frac{\varepsilon}{2}$, for every $t \in [a, b]$.

Define the polynomial p by $p(t) = p'(t) - p'(0)$, for all $t \in [a, b]$, and note that $|p'(0)| < \frac{\varepsilon}{2}$. So we have $p(0) = 0$ and

$$||t| - p(t)| = ||t| - p'(t) + p'(0)| \leq ||t| - p'(t)| + |p'(0)| < \varepsilon, \text{ for every } t \in [a, b].$$

Since \mathcal{A} is an algebra, the function $p(f) \in C(X, \mathbb{R})$, given by $(p(f))(x) = p(f(x))$ for all $x \in X$, is in \mathcal{A} . Since $f(x) \in [a, b]$, for all $x \in X$, the previous paragraph implies that $||f(x)| - p(f(x))| < \varepsilon$, for all $x \in X$. So $||f| - p(f)| < \varepsilon$. As $p(f) \in \mathcal{A}$ and \mathcal{A} is a closed set, this implies that $|f| \in \mathcal{A}$, which completes the proof. \square

12.2.20 Theorem. [The (Real) Stone-Weierstrass Theorem] Let X be a compact Hausdorff space and \mathcal{A} a closed subalgebra of $C(X, \mathbb{R})$ which contains a non-zero constant function. Then $\mathcal{A} = C(X, \mathbb{R})$ if and only if \mathcal{A} separates points of X .

Proof. Firstly, from [Proposition 12.2.3](#), if $\mathcal{A} = C(X, \mathbb{R})$ then \mathcal{A} must separate points of X .

We now consider the case that \mathcal{A} separates points of X .

If X has only one point, then each $f \in C(X, \mathbb{R})$ is a constant function and as \mathcal{A} contains a non-zero constant function and is an algebra, it contains all constant functions and so equals $C(X, \mathbb{R})$.

So consider the case that X has more than one point. By [Proposition 12.2.17](#) and [Proposition 12.2.19](#) it suffices to show that if $x, y \in X$ with $x \neq y$ and $a, b \in \mathbb{R}$, there exists $f \in \mathcal{A}$ such that $f(x) = a$ and $f(y) = b$. As \mathcal{A} separates points of X , there exists a $g \in \mathcal{A}$, such that $g(x) \neq g(y)$. So we define $f : X \rightarrow \mathbb{R}$ by

$$f(z) = a \frac{g(z) - g(y)}{g(x) - g(y)} + b \frac{g(z) - g(x)}{g(y) - g(x)}, \text{ for } z \in X.$$

Then f has the required properties, which completes the proof. □

12.2.21 Remark. If $f : X \rightarrow \mathbb{C}$ is any function from a set X into \mathbb{C} , then we can write $f(x) = \mathcal{R}(f)(x) + i\mathcal{I}(f)(x)$, where $\mathcal{R}(f)(x) \in \mathbb{R}$ and $\mathcal{I}(f)(x) \in \mathbb{R}$. So $f = \mathcal{R}(f) + i\mathcal{I}(f)$. The **conjugate function**, \bar{f} is defined to be $\mathcal{R}(f) - i\mathcal{I}(f)$. Note that

$$\mathcal{R}(f) = \frac{f + \bar{f}}{2} \text{ and } \mathcal{I}(f) = \frac{f - \bar{f}}{2i}.$$

12.2.22 Theorem. [The (Complex) Stone-Weierstrass Theorem]

Let X be a compact Hausdorff space and \mathcal{A} a closed subalgebra of $C(X, \mathbb{C})$ which contains a non-zero constant function. Then $\mathcal{A} = C(X, \mathbb{C})$ if and only if $f \in \mathcal{A}$ implies the conjugate function $\bar{f} \in \mathcal{A}$ and \mathcal{A} separates points of X .

Proof. From [Proposition 12.2.3](#), if $\mathcal{A} = C(X, \mathbb{C})$, \mathcal{A} must separate points of X and obviously $f \in \mathcal{A} = C(X, \mathbb{C})$ implies the conjugate function $\bar{f} \in \mathcal{A}$.

So we consider the converse statement. Define \mathcal{B} to be the real-valued functions in \mathcal{A} . Clearly \mathcal{B} is a closed subalgebra of $C(X, \mathbb{R})$. We claim that it suffices to prove that $\mathcal{B} = C(X, \mathbb{R})$. This is so, since if $f \in C(X, \mathbb{C})$, then $\mathcal{R}(f)$ and $\mathcal{I}(f)$ are in $C(X, \mathbb{R})$ and so in $\mathcal{B} = C(X, \mathbb{R})$, and so \mathcal{A} would be $C(X, \mathbb{C})$.

We shall use the [Real Stone-Weierstrass Theorem 12.2.20](#) to prove that $\mathcal{B} = C(X, \mathbb{R})$. Let $f \in C(X, \mathbb{C})$ separate points of X . Then either $\mathcal{R}(f)$ or $\mathcal{I}(f)$ (or both) separate points of X ; so \mathcal{B} separates points of X . Now \mathcal{A} contains a non-constant function g . As \mathcal{A} is an algebra, the conjugate function \bar{g} is also in \mathcal{A} . So the non-constant real-valued function $g\bar{g} = |g|^2 \in \mathcal{B}$. So by the [Real Stone-Weierstrass Theorem 12.2.20](#), $\mathcal{B} = C(X, \mathbb{R})$, which completes the proof. \square

7.2.23 Remark. The [Weierstrass Approximation Theorem 12.1.5](#) is of course a special case of [The \(Complex\) Stone-Weierstrass Theorem 12.2.22](#). It is the case $X = [a, b] \subset \mathbb{R}$ and \mathcal{A} is the set of all polynomials. \square

12.2.24 Remark. We mentioned at the beginning of §12.1 that in 1885 Karl Weierstrass was aged 70, when he proved the [The Weierstrass Approximation Theorem 12.1.5](#). In contrast, in 1899 the Hungarian Jewish mathematician Lipót Fejér (1880–1959), aged 19, proved the trigonometric polynomial version of this theorem from which [The Weierstrass Approximation Theorem 12.1.5](#) can be derived. Lipót Fejér was born Lipót Weiss and changed his name in high school as he expected less antisemitism. Research students that he supervised included: Marcel Riesz, George Pólya, Gábor Szegő, John von Neumann, Pál Turán, and Paul Erdős - an incredible heritage.



Fejér



Riesz



Pólya



Szegő



von Neumann



Turán



Erdős

12.2.25 Definition. Let $a_0, a_n, b_n \in \mathbb{R}$, $n = 1, 2, \dots, N$, $N \in \mathbb{N}$ with either $a_N \neq 0$ or $b_N \neq 0$. Then the function $f : \mathbb{R} \rightarrow \mathbb{R}$ given by

$$f(x) = a_0 + \sum_{n=1}^N a_n \cos(nx) + b_n \sin(nx), \text{ for } x \in \mathbb{R}$$

is said to be a **real trigonometric polynomial of degree N** .

12.2.26 Definition. Let $a_0, a_n, b_n \in \mathbb{C}$, $n = 1, 2, \dots, N$, $N \in \mathbb{N}$ with either $a_N \neq 0$ or $b_N \neq 0$. Then the function $f : \mathbb{R} \rightarrow \mathbb{C}$ given by

$$f(x) = a_0 + \sum_{n=1}^N a_n \cos(nx) + i b_n \sin(nx), \text{ for } x \in \mathbb{R}$$

is said to be a **complex trigonometric polynomial of degree N** .

12.2.27 Remark. We observe that if f is a real trigonometric polynomial or a complex trigonometric polynomial then

$$f(x) = f(x + 2\pi) = f(x + 2k\pi), \text{ for all } k \in \mathbb{N} \text{ and } x \in \mathbb{R}. \quad (21)$$

We shall prove that every function $f : \mathbb{R} \rightarrow \mathbb{R}$ satisfying (21) can be approximated by real trigonometric polynomials and every function $f : \mathbb{R} \rightarrow \mathbb{C}$ satisfying (21) can be approximated by complex trigonometric polynomials. \square

12.2.29 Remark. Let \mathbb{T} denote the circle of diameter one centred at 0 in the euclidean space \mathbb{R}^2 with the subspace topology from \mathbb{R}^2 . Of course \mathbb{T} is a compact Hausdorff space. Further, any function $f : \mathbb{R} \rightarrow \mathbb{R}$ or $f : \mathbb{R} \rightarrow \mathbb{C}$ which satisfies (21) can be thought of as a function from \mathbb{T} to \mathbb{R} or from \mathbb{T} to \mathbb{C} . Further, f is a continuous function if and only if the corresponding function from \mathbb{T} to \mathbb{R} or \mathbb{C} is continuous. \square

12.2.30 Corollary. The algebra of all real trigonometric polynomials is dense in $C(\mathbb{T}, \mathbb{R})$ and the algebra of all complex trigonometric polynomials is dense in $C(\mathbb{T}, \mathbb{C})$.

Proof. These results follow from [The Real Stone-Weierstrass Theorem 12.2.20](#) and [The Complex Stone-Weierstrass Theorem 12.2.22](#). [Exercise] \square

12.2.31 Remark. Lord Kelvin⁴ (see Kelvin [234]), was interested in correcting the magnetic compass in ships, which usually had a lot of iron and steel, in order to get a true north reading and was also interested in predicting tides. Both of these problems were able to be addressed using trigonometric polynomial approximation. For a discussion see Sury [387].

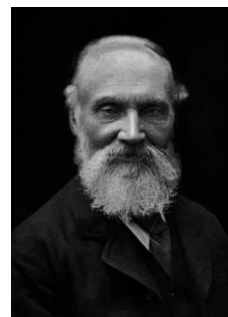

Kelvin

We conclude this section with an interesting remark, unrelated to the Stone-Weierstrass Theorem, on the spaces $C(X, \mathbb{R})$.

12.2.31 Remark. While $C([0, 1], \mathbb{R})$ is just one separable Banach space, the following result says it is much richer than you may have thought. Indeed it is a universal separable metric space, as described below.

Banach Mazur Theorem. Every separable Banach space is isometrically embeddable as a metric space in $C([0, 1], \mathbb{R})$.

From the Banach-Alaoglu Theorem, Exercises 10.3 #33 (vii) and the Hahn-Banach Theorem⁵ the following beautiful generalization can be deduced.

If B is any Banach space, then there exists a compact Hausdorff space X such that B is isometrically embeddable as a metric space in $C(X, \mathbb{R})$.

(See Maddox [271], Theorem 27.)

As a generalization of the concept of separability of a topological space, we introduce the following notion. The **density character** of a topological space X is the least cardinal number of a dense subspace of X . In 1969 Kleiber and Pervin [239] proved the next theorem:

The topological space $C([0, 1]^{\aleph}, \mathbb{R})$ with the uniform topology is a universal metric space of density character \aleph ; that is, $C([0, 1]^{\aleph}, \mathbb{R})$ has density character \aleph and every metric space of density character \aleph is isometrically embedded as a subspace of $C([0, 1]^{\aleph}, \mathbb{R})$.

⁴William Thompson (1824-1907), born in Belfast, Ireland, was the son of the Professor of Mathematics at Glasgow University. He attended university classes from the age of 10. He graduated from Cambridge University and at the age of 22 returned to Glasgow University to become Professor of Natural Sciences, a position he held for over half a century. He became a Lord in 1892, and took the name Kelvin.

⁵<https://tinyurl.com/zj9byaj>

Exercises 12.2

1. Verify that the subset S of $C([0, 1], \mathbb{R})$ consisting of all polynomials in $C[0, 1]$ with rational number coefficients is not a subalgebra of $C[0, 1]$.
2. Prove that the set M_n of all $n \times n$ matrices with real number entries is an algebra over \mathbb{R} in [Example 12.2.3](#) is a non-commutative associative unital algebra over \mathbb{R} .
3. Let X be a compact Hausdorff space, \mathcal{A} a subalgebra of $C(X, F)$, where F is \mathbb{C} or \mathbb{R} , and \mathcal{B} the closure in $C(X, F)$ of \mathcal{A} . Prove that
 - (i) \mathcal{B} is a subalgebra of $C(X, F)$;
 - (ii) if \mathcal{A} contains the conjugate of each of its functions, then so does \mathcal{B} .
4. Verify [Example 12.2.6 \(iii\)](#).
5. Verify [Example 7.2.9](#) is correct.
6. Prove [Proposition 12.2.10](#).
7. Verify [Lemma 7.2.16](#).
8. Let X be a locally compact Hausdorff space and f a continuous function from X into F , where F is \mathbb{C} or \mathbb{R} . Then f is said to **vanish at infinity** if for each $\varepsilon > 0$, there exists a compact subset K of X such that $|f(x)| < \varepsilon$, for all $x \in X \setminus K$. Let $C_0(X, F)$ be the Banach algebra of all continuous functions which vanish at infinity. Prove that $C_0(X, F)$ with the sup norm is a Banach algebra and is unital Banach algebra if and only if X is compact.

9. Let \mathcal{A} be a Banach algebra over \mathbb{C} . Then \mathcal{A} is said to be a **C*-algebra**^{6 7} if there is a map $*$: $\mathcal{A} \rightarrow \mathcal{A}$ which satisfies (i)–(v).

(i) $x^{**} = (x^*)^* = x$, for every $x \in \mathcal{A}$; that is $*$ is an involution;

(ii) $(x + y)^* = x^* + y^*$, for every $x, y \in \mathcal{A}$;

(iii) $(x \cdot y)^* = y^* \cdot x^*$, for every $x, y \in \mathcal{A}$;

(iv) $(\alpha x)^* = \bar{\alpha}x^*$, for every $x \in \mathcal{A}$ and $\alpha \in \mathbb{C}$, where $\bar{\alpha}$ denotes the complex conjugate of the complex number α ;

(v) $\|x^* \cdot x\| = \|x\|^2$, for every $x \in \mathcal{A}$.

For any $x \in \mathcal{A}$, x^* is called the **adjoint** of x .

(a) Using the fact that in any Banach algebra \mathcal{A} , $\|x \cdot y\| \leq \|x\| \|y\|$, for all $x, y \in \mathcal{A}$, verify that $\|x\| = \|x^*\|$.

(b) Prove that if X is a compact Hausdorff space, then the unital commutative associative Banach algebra $C(X, \mathbb{C})$ is a C*-algebra if for each $f \in C(X, \mathbb{C})$ we define $f^* : X \rightarrow \mathbb{C}$ by $f^*(x) = \overline{f(x)}$, for every $x \in X$, where $\overline{f(x)}$ denotes the complex conjugate of the complex number $f(x)$.

Let \mathcal{A} and \mathcal{B} be C*-algebras. Then \mathcal{A} is said to be **isomorphic as a C*-algebra** to \mathcal{B} if there is a surjective one-to-one mapping $\phi : \mathcal{A} \rightarrow \mathcal{B}$ such that $\phi(x + y) = \phi(x) + \phi(y)$, $\phi(\alpha x) = \alpha\phi(x)$, $\phi(x \cdot y) = \phi(x) \cdot \phi(y)$, and $\phi(x^*) = (\phi(x))^*$, for all $x, y \in \mathcal{A}$ and $\alpha \in \mathbb{C}$. The **Gelfand-Naimark Representation Theorem**, proved using the Stone-Weierstrass Theorem, says **every commutative unital C*-algebra \mathcal{A} is isomorphic as a C*-algebra to $C(X, \mathbb{C})$, for some compact Hausdorff space X .**

More generally, **every commutative C*-algebra \mathcal{A} is isomorphic as a C*-algebra to $C_0(X, \mathbb{C})$, for some locally compact Hausdorff space X .** (See Lang [252], Chapter 16, Theorem 3.3.)

It is also worth mentioning that $C(X, \mathbb{C})$ is isomorphic as a C*-algebra to $C(Y, \mathbb{C})$, for compact Hausdorff spaces X and Y , if and only if X is homeomorphic to Y . (See Lin [261], Theorem 1.3.9.)

⁶The concept of a C*-algebra has its roots in the work on quantum mechanics of Werner Karl Heisenberg (1901–1976), Erwin Rudolf Josef Alexander Schrödinger (1887–1961), and John von Neumann (1903–1957) in the 1920s. (See Landsman [251].)

⁷Gelfand and Naimark [151]

12.3 Credit for Images

1. Jacob Bernoulli. Public Domain.
2. Sergei Natanovich Bernstein. Public Domain.
3. Pierre Bezier portrait. Creative Commons. <https://commons.wikimedia.org/wiki/File:Pierre-bezier-portrait.jpg>
4. Ulisse Dini. Public Domain.
5. Paul Erdős. Photo taken by author November 23, 1979 at the University of Calgary.
6. Lipót Fejér. Public Domain.
7. Lord Kelvin (William Thompson). Public Domain
8. George Pólya. Public Domain.
9. Marcel Riesz. Public Domain.
10. Marshall Stone. Public Domain.
11. Gábor Szegő. Public Domain.
12. Pál Turán. Public Domain.
13. John von Neumann. Public Domain.
14. Rudolf Výborný. Privately owned photo.
15. Karl Weierstrass. Public Domain.

Appendix 1: Infinite Sets

§A1.0 Introduction	391
§A1.1 Countable Sets	393
§A1.2 Cardinal Numbers	404
§A1.3 Cardinal Arithmetic	409
§A1.4 Ordinals	415
§A1.5 Credits for Images	424

A1.0 Introduction

"The Infinite! No other question has ever moved so profoundly the spirit of man." - David Hilbert (1921)

Once upon a time in a far-off land there were two hotels, the Hotel Finite (an ordinary hotel with a finite number of rooms) and Hilbert's Hotel Infinite (an extraordinary hotel with an infinite number of rooms numbered $1, 2, \dots, n, \dots$). One day a visitor arrived in town seeking a room. She went first to the Hotel Finite and was informed that all rooms were occupied and so she could not be accommodated, but she was told that the other hotel, Hilbert's Hotel Infinite, can always find an extra room. So she went to Hilbert's Hotel Infinite and was told that there too all rooms were occupied. However, the desk clerk said at this hotel an extra guest can always be accommodated without evicting anyone. He moved the guest from room 1 to room 2, the guest from room 2 to room 3, and so on. Room 1 then became vacant!

From this cute example we see that there is an intrinsic difference between infinite sets and finite sets. The aim of this Appendix is to provide a gentle but very brief introduction to the theory of Infinite Sets⁸. This is a fascinating topic which, if you have not studied it before, will contain several surprises. We shall learn that "infinite sets were not created equal" - some are bigger than others. At first pass it is not at all clear what this statement could possibly mean. We will need to define the term "bigger". Indeed we will need to define what we mean by "two sets are the same size".

⁸There is available for free download a rather nice and gentle book on set theory. It is by Raymond L. Wilder and is called Introduction to the Foundations of Mathematics. It is available from <http://archive.org/details/IntroductionToTheFoundationsOfMathematics>

There are three videos which you should watch as they provide supplementary material to this Appendix. These videos are called “Topology Without Tears – Video 2a, 2b, and 2c – Infinite Set Theory”.

Part (a) is on YouTube at <http://youtu.be/9h83ZJeiecg> and on the Chinese Youku site at <http://tinyurl.com/m4dlzhh>.

Part (b) is on YouTube at <http://youtu.be/QPSRB4Fhzko> and on the Chinese Youku site at <http://tinyurl.com/kf9lp8e>.

Part (c) is on YouTube at <http://youtu.be/YvqUnjjQ3TQ> and on the Chinese Youku site at <http://tinyurl.com/mhlqe93>.

These videos include a discussion of the Zermelo-Fraenkel (ZF) axioms of Set Theory and a short proof showing that the Russell Paradox does not occur within ZF set theory.

A1.1 Countable Sets

A1.1.1 Definitions. Let A and B be sets. Then A is said to be **equipotent** to B , denoted by $A \sim B$, if there exists a function $f : A \rightarrow B$ which is both one-to-one and onto (that is, f is a **bijection** or a **one-to-one correspondence**).

A1.1.2 Proposition. Let A , B , and C be sets.

- (i) Then $A \sim A$.
- (ii) If $A \sim B$ then $B \sim A$.
- (iii) If $A \sim B$ and $B \sim C$ then $A \sim C$.

Outline Proof.

- (i) The identity function f on A , given by $f(x) = x$, for all $x \in A$, is a one-to-one correspondence between A and itself.
- (ii) If f is a bijection of A onto B then it has an inverse function g from B to A and g is also a one-to-one correspondence.
- (iii) If $f : A \rightarrow B$ is a one-to-one correspondence and $g : B \rightarrow C$ is a one-to-one correspondence, then their composition $gf : A \rightarrow C$ is also a one-to-one correspondence. □

Proposition A1.1.2 says that the relation “ \sim ” is reflexive (i), symmetric (ii), and transitive (iii); that is, “ \sim ” is an **equivalence relation**.

A1.1.3 Proposition. Let $n, m \in \mathbb{N}$. Then the sets $\{1, 2, \dots, n\}$ and $\{1, 2, \dots, m\}$ are equipotent if and only if $n = m$.

Proof. Exercise. □

Now we explicitly define the terms “finite set” and “infinite set”.

A1.1.4 Definitions. Let S be a set.

- (i) Then S is said to be **finite** if it is the empty set, \emptyset , or it is equipotent to $\{1, 2, \dots, n\}$, for some $n \in \mathbb{N}$.
- (ii) If S is not finite, then it is said to be **infinite**.
- (iii) If $S \sim \{1, 2, \dots, n\}$ then S is said to have **cardinality** n , which is denoted by **card** $S = n$.
- (iv) If $S = \emptyset$ then the cardinality is said to be 0, which is denoted by **card** $\emptyset = 0$.

The next step is to define the “smallest” kind of infinite set. Such sets will be called countably infinite. At this stage we do not know that there is any “bigger” kind of infinite set – indeed we do not even know what “bigger” would mean in this context.

A1.1.5 Definitions. Let S be a set.

- (i) The set S is said to be **countably infinite** (or **denumerable**) if it is equipotent to \mathbb{N} .
- (ii) The set S is said to be **countable** if it is finite or countably infinite.
- (iii) If S is countably infinite then it is said to have **cardinality** \aleph_0 , denoted by **card** $S = \aleph_0$.
- (iv) A set S is said to be **uncountable** if it is not countable.

A1.1.6 Remark. If the set S is countably infinite, then $S = \{s_1, s_2, \dots, s_n, \dots\}$ where $f : \mathbb{N} \rightarrow S$ is a one-to-one correspondence and $s_n = f(n)$, for all $n \in \mathbb{N}$. So we can **list** the elements of S . Of course if S is finite and non-empty, we can also list its elements by $S = \{s_1, s_2, \dots, s_n\}$. So we can list the elements of any countable set. Conversely, **if the elements of S can be listed, then S is countable** as the listing defines a one-to-one correspondence with \mathbb{N} or $\{1, 2, \dots, n\}$. \square

A1.1.7 Example. The set S of all even positive integers is countably infinite.

Proof. The function $f : \mathbb{N} \rightarrow S$ given by $f(n) = 2n$, for all $n \in \mathbb{N}$, is a one-to-one correspondence. \square

Example A1.1.7 is worthy of a little contemplation. We think of two sets being in one-to-one correspondence if they are “the same size”. But here we have the set \mathbb{N} in one-to-one correspondence with one of its proper subsets. This does not happen with finite sets. Indeed finite sets can be characterized as those sets which are not equipotent to any of their proper subsets.

A1.1.8 Example. The set \mathbb{Z} of all integers is countably infinite.

Proof. The function $f : \mathbb{N} \rightarrow \mathbb{Z}$ given by

$$f(n) = \begin{cases} m, & \text{if } n = 2m, m \geq 1 \\ -m, & \text{if } n = 2m + 1, m \geq 1 \\ 0, & \text{if } n = 1. \end{cases}$$

is a one-to-one correspondence. \square

A1.1.9 Example. The set S of all positive integers which are perfect squares is countably infinite.

Proof. The function $f : \mathbb{N} \rightarrow S$ given by $f(n) = n^2$ is a one-to-one correspondence. \square

Example A1.1.9 was proved about 1600 by the Italian astronomer, engineer, and physicist Galileo Galilei (1564–1642). It troubled him and suggested to him that the infinite is not man’s domain. Galileo has been described as the “father of modern physics”, the “father of the scientific method”, and the “father of modern science”.

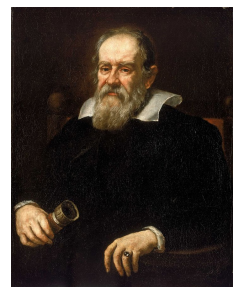

Galileo

A1.1.10 Proposition. If a set S is equipotent to a countable set then it is countable.

Proof. Exercise. \square

A1.1.11 Proposition. If S is a countable set and $T \subset S$ then T is countable.

Proof. Since S is countable we can write it as a list $S = \{s_1, s_2, \dots\}$ (a finite list if S is finite, an infinite one if S is countably infinite).

Let t_1 be the first s_i in T (if $T \neq \emptyset$). Let t_2 be the second s_i in T (if $T \neq \{t_1\}$). Let t_3 be the third s_i in T (if $T \neq \{t_1, t_2\}$), \dots

This process comes to an end only if $T = \{t_1, t_2, \dots, t_n\}$ for some n , in which case T is finite. If the process does not come to an end we obtain a list $\{t_1, t_2, \dots, t_n, \dots\}$ of members of T . This list contains every member of T , because if $s_i \in T$ then we reach s_i no later than the i^{th} step in the process; so s_i occurs in the list. Hence T is countably infinite. So T is either finite or countably infinite. \square

As an immediate consequence of [Proposition A1.1.11](#) and [Example A1.1.8](#) we have the following result.

A1.1.12 Corollary. Every subset of \mathbb{Z} is countable. \square

A1.1.13 Lemma. If $S_1, S_2, \dots, S_n, \dots$ is a countably infinite family of countably infinite sets such that $S_i \cap S_j = \emptyset$ for $i \neq j$, then $\bigcup_{i=1}^{\infty} S_i$ is a countably infinite set.

Proof. As each S_i is a countably infinite set, $S_i = \{s_{i1}, s_{i2}, \dots, s_{in}, \dots\}$. Now put the s_{ij} in a square array and list them by zigzagging up and down the short diagonals.

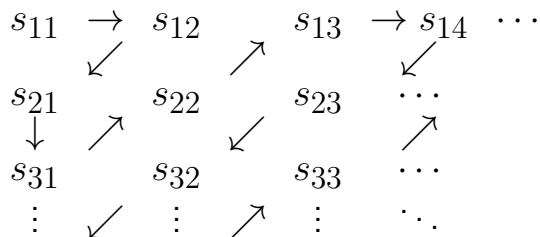

This shows that all members of $\bigcup_{i=1}^{\infty} S_i$ are listed, and the list is infinite because each S_i is infinite. So $\bigcup_{i=1}^{\infty} S_i$ is countably infinite. \square

In [Lemma A1.1.13](#) we assumed that the sets S_i were pairwise disjoint. If they are not pairwise disjoint the proof is easily modified by deleting repeated elements to obtain:

A1.1.14 Lemma. If $S_1, S_2, \dots, S_n, \dots$ is a countably infinite family of countably infinite sets, then $\bigcup_{i=1}^{\infty} S_i$ is a countably infinite set. \square

A1.1.15 Proposition. The union of any countable family of countable sets is countable.

Proof. Exercise. \square

A1.1.16 Proposition. If S and T are countably infinite sets then the product set $S \times T = \{\langle s, t \rangle : s \in S, t \in T\}$ is a countably infinite set.

Proof. Let $S = \{s_1, s_2, \dots, s_n, \dots\}$ and $T = \{t_1, t_2, \dots, t_n, \dots\}$. Then

$$S \times T = \bigcup_{i=1}^{\infty} \{\langle s_i, t_1 \rangle, \langle s_i, t_2 \rangle, \dots, \langle s_i, t_n \rangle, \dots\}.$$

So $S \times T$ is a countably infinite union of countably infinite sets and is therefore countably infinite. \square

A1.1.17 Corollary. Every finite product of countable sets is countable. \square

We are now ready for a significant application of our observations on countable sets.

A1.1.18 Lemma. The set, $\mathbb{Q}^{>0}$, of all positive rational numbers is countably infinite.

Proof. Let S_i be the set of all positive rational numbers (see Niven [317]) with denominator i , for $i \in \mathbb{N}$. Then $S_i = \left\{ \frac{1}{i}, \frac{2}{i}, \dots, \frac{n}{i}, \dots \right\}$ and $\mathbb{Q}^{>0} = \bigcup_{i=1}^{\infty} S_i$. As each S_i is countably infinite, [Proposition A1.1.15](#) yields that $\mathbb{Q}^{>0}$ is countably infinite. \square

We are now ready to prove that the set, \mathbb{Q} , of all rational numbers is countably infinite; that is, there exists a one-to-one correspondence between the set \mathbb{Q} and the (seemingly) very much smaller set, \mathbb{N} , of all positive integers.

A1.1.19 Theorem. The set \mathbb{Q} of all rational numbers is countably infinite.

Proof. Clearly the set $\mathbb{Q}^{<0}$ of all negative rational numbers is equipotent to the set, $\mathbb{Q}^{>0}$, of all positive rational numbers and so using [Proposition A1.1.10](#) and [Lemma A1.1.18](#) we obtain that $\mathbb{Q}^{<0}$ is countably infinite.

Finally observe that \mathbb{Q} is the union of the three sets $\mathbb{Q}^{>0}$, $\mathbb{Q}^{<0}$ and $\{0\}$ and so it too is countably infinite by [Proposition A1.1.15](#). \square

A1.1.20 Corollary. Every set of rational numbers is countable.

Proof. This is a consequence of [Theorem A1.1.19](#) and [Proposition A1.1.11](#). \square

A1.1.21 Definitions. A real number x is said to be an **algebraic number** if there is a natural number n and integers a_0, a_1, \dots, a_n with $a_0 \neq 0$ such that

$$a_0x^n + a_1x^{n-1} + \dots + a_{n-1}x + a_n = 0.$$

A real number which is not an algebraic number is said to be a **transcendental number**.

A1.1.22 Example. Every rational number is an algebraic number.

Proof. If $x = \frac{p}{q}$, for $p, q \in \mathbb{Z}$ and $q \neq 0$, then $qx - p = 0$; that is, x is an algebraic number with $n = 1$, $a_0 = q$, and $a_n = -p$. \square

A1.1.23 Example. The number $\sqrt{2}$ is an algebraic number which is not a rational number.

Proof. While $x = \sqrt{2}$ is irrational, it satisfies $x^2 - 2 = 0$ and so is algebraic. \square

A1.1.24 Remark. It is also easily verified that $\sqrt[4]{5} - \sqrt{3}$ is an algebraic number since it satisfies $x^8 - 12x^6 + 44x^4 - 288x^2 + 16 = 0$. Indeed any real number which can be constructed from the set of integers using only a finite number of the operations of addition, subtraction, multiplication, division and the extraction of square roots, cube roots, . . . , is algebraic. \square

A1.1.25 Remark. [Remark A1.1.24](#) shows that “most” numbers we think of are algebraic numbers. To show that a given number is transcendental can be extremely difficult. The first such demonstration was in 1844 when Liouville proved the transcendence of the number

$$\sum_{n=1}^{\infty} \frac{1}{10^{n!}} = 0.11000100000000000000000000100\dots$$

It was Charles Hermite who, in 1873, showed that e is transcendental. In 1882 Lindemann proved that the number π is transcendental thereby answering in the negative the 2,000 year old question about squaring the circle. (The question is: given a circle of radius 1, is it possible, using only a straight edge and compass, to construct a square with the same area? A full exposition of this problem and proofs that e and π are transcendental are to be found in the book, Jones, Morris, and Pearson [221].) \square

We now proceed to prove that the set \mathcal{A} of all algebraic numbers is also countably infinite. This is a more powerful result than [Theorem A1.1.19](#) which is in fact a corollary of this result.

A1.1.26 Theorem. The set \mathcal{A} of all algebraic numbers is countably infinite.

Proof. Consider the polynomial $f(x) = a_0x^n + a_1x^{n-1} + \cdots + a_{n-1}x + a_n$, where $a_0 \neq 0$ and each $a_i \in \mathbb{Z}$ and define its **height** to be $k = n + |a_0| + |a_1| + \cdots + |a_n|$.

For each positive integer k , let A_k be the set of all roots of all such polynomials of height k . Clearly $\mathcal{A} = \bigcup_{k=1}^{\infty} A_k$.

Therefore, to show that \mathcal{A} is countably infinite, it suffices by Proposition A1.1.15 to show that each A_k is finite.

If f is a polynomial of degree n , then clearly $n \leq k$ and $|a_i| \leq k$, for $i = 0, 1, 2, \dots, n$. So the set of all polynomials of height k is certainly finite.

Further, a polynomial of degree n has at most n roots. Consequently each polynomial of height k has no more than k roots. Hence the set A_k is finite, as required. \square

A1.1.27 Corollary. Every set of algebraic numbers is countable. \square

Note that [Corollary A1.1.27](#) has as a special case, [Corollary A1.1.20](#).

So far we have not produced any example of an uncountable set. Before doing so we observe that certain mappings will not take us out of the collection of countable sets.

A1.1.28 Proposition. Let X and Y be sets and f a map of X into Y .

- (i) If X is countable and f is surjective (that is, an onto mapping), then Y is countable.
- (ii) If Y is countable and f is injective (that is, a one-to-one mapping), then X is countable.

Proof. Exercise. \square

A1.1.29 Proposition. Let S be a countable set. Then the set of all finite subsets of S is also countable.

Proof. Exercise. □

A1.1.30 Definition. Let S be any set. The set of all subsets of S is said to be the **power set** of S and is denoted by $\mathcal{P}(S)$.

A1.1.31 Theorem. (Georg Cantor) For every set S , the power set, $\mathcal{P}(S)$, is not equipotent to S ; that is, $\mathcal{P}(S) \not\sim S$.

Proof. We have to prove that there is no one-to-one correspondence between S and $\mathcal{P}(S)$. We shall prove more: that there is not even any surjective function mapping S onto $\mathcal{P}(S)$.

Suppose that there exists a function $f: S \rightarrow \mathcal{P}(S)$ which is onto. For each $x \in S$, $f(x) \in \mathcal{P}(S)$, which is the same as saying that $f(x) \subseteq S$.

Let $T = \{x : x \in S \text{ and } x \notin f(x)\}$. Then $T \subseteq S$; that is, $T \in \mathcal{P}(S)$. So $T = f(y)$ for some $y \in S$, since f maps S onto $\mathcal{P}(S)$. Now $y \in T$ or $y \notin T$.

Case 1.

$$\begin{aligned} y \in T &\Rightarrow y \notin f(y) \quad (\text{by the definition of } T) \\ &\Rightarrow y \notin T \quad (\text{since } f(y) = T). \end{aligned}$$

So Case 1 is impossible.

Case 2.

$$\begin{aligned} y \notin T &\Rightarrow y \in f(y) \quad (\text{by the definition of } T) \\ &\Rightarrow y \in T \quad (\text{since } f(y) = T). \end{aligned}$$

So Case 2 is impossible.

As both cases are impossible, we have a contradiction. So our supposition is false and there does not exist any function mapping S onto $\mathcal{P}(S)$. Thus $\mathcal{P}(S)$ is not equipotent to S . □

A1.1.32 Lemma. If S is any set, then S is equipotent to a subset of its power set, $\mathcal{P}(S)$.

Proof. Define the mapping $f: S \rightarrow \mathcal{P}(S)$ by $f(x) = \{x\}$, for each $x \in S$. Clearly f is a one-to-one correspondence between the sets S and $f(S)$. So S is equipotent to the subset $f(S)$ of $\mathcal{P}(S)$. \square

A1.1.33 Proposition. If S is any infinite set, then $\mathcal{P}(S)$ is an uncountable set.

Proof. As S is infinite, the set $\mathcal{P}(S)$ is infinite. By [Theorem A1.1.31](#), $\mathcal{P}(S)$ is not equipotent to S .

Suppose $\mathcal{P}(S)$ is countably infinite. Then by [Proposition A1.1.11](#), [Lemma A1.1.32](#) and [Proposition A1.1.10](#), S is countably infinite. So S and $\mathcal{P}(S)$ are equipotent, which is a contradiction. Hence $\mathcal{P}(S)$ is uncountable. \square

[Proposition A1.1.33](#) demonstrates the existence of uncountable sets. However the sceptic may feel that the example is contrived. So we conclude this section by observing that important and familiar sets are uncountable.

A1.1.34 Lemma. The set of all real numbers in the half open interval $[1, 2)$ is not countable.

Proof. (Cantor's diagonal argument) We shall show that the set of all real numbers in $[1, 2)$ cannot be listed.

Let $L = \{r_1, r_2, \dots, r_n \dots\}$ be any list of real numbers each of which lies in the set $[1, 2)$. Write down their decimal expansions:

$$\begin{aligned} r_1 &= 1.r_{11}r_{12} \dots r_{1n} \dots \\ r_2 &= 1.r_{21}r_{22} \dots r_{2n} \dots \\ &\vdots \\ r_m &= 1.r_{m1}r_{m2} \dots r_{mn} \dots \\ &\vdots \end{aligned}$$

Consider the real number a defined to be $1.a_1a_2 \dots a_n \dots$ where, for each $n \in \mathbb{N}$,

$$a_n = \begin{cases} 1 & \text{if } r_{nn} \neq 1 \\ 2 & \text{if } r_{nn} = 1. \end{cases}$$

Clearly $a_n \neq r_{nn}$ and so $a \neq r_n$, for all $n \in \mathbb{N}$. Thus a does not appear anywhere in the list L . Thus there does not exist a listing of the set of all real numbers in $[1, 2)$; that is, this set is uncountable. \square

A1.1.35 Theorem. The set, \mathbb{R} , of all real numbers is uncountable.

Proof. Suppose \mathbb{R} is countable. Then by [Proposition A1.1.11](#) the set of all real numbers in $[1, 2)$ is countable, which contradicts [Lemma A1.1.34](#). Therefore \mathbb{R} is uncountable. \square

A1.1.36 Corollary. The set, \mathbb{I} , of all irrational numbers is uncountable.

Proof. Suppose \mathbb{I} is countable. Then \mathbb{R} is the union of two countable sets: \mathbb{I} and \mathbb{Q} . By [Proposition A1.1.15](#), \mathbb{R} is countable which is a contradiction. Hence \mathbb{I} is uncountable. \square

Using a similar proof to that in [Corollary A1.1.36](#) we obtain the following result.

A1.1.37 Corollary. The set of all transcendental numbers is uncountable. \square

A1.2 Cardinal Numbers

In the previous section we defined countably infinite and uncountable and suggested, without explaining what it might mean, that uncountable sets are “bigger” than countably infinite sets. To explain what we mean by “bigger” we will need the next theorem.

Our exposition is based on that in the book, Halmos [[168](#)]

A1.2.1 Theorem. (Cantor-Schröder-Bernstein) Let S and T be sets. If S is equipotent to a subset of T and T is equipotent to a subset of S , then S is equipotent to T .

Proof. Without loss of generality we can assume S and T are disjoint. Let $f : S \rightarrow T$ and $g : T \rightarrow S$ be one-to-one maps. We are required to find a bijection of S onto T .

We say that an element s is a **parent** of an element $f(s)$ and $f(s)$ is a **descendant** of s . Also t is a parent of $g(t)$ and $g(t)$ is a descendant of t . Each $s \in S$ has an infinite sequence of descendants: $f(s), g(f(s)), f(g(f(s)))$, and so on. We say that each term in such a sequence is an **ancestor** of all the terms that follow it in the sequence.

Now let $s \in S$. If we trace its ancestry back as far as possible one of three things must happen:

- (i) the list of ancestors is finite, and stops at an element of S which has no ancestor;
- (ii) the list of ancestors is finite, and stops at an element of T which has no ancestor;
- (iii) the list of ancestors is infinite.

Let S_S be the set of those elements in S which originate in S ; that is, S_S is the set $S \setminus g(T)$ plus all of its descendants in S . Let S_T be the set of those elements which originate in T ; that is, S_T is the set of descendants in S of $T \setminus f(S)$. Let S_∞ be the set of all elements in S with no parentless ancestors. Then S is the union of the three disjoint sets S_S, S_T and S_∞ . Similarly T is the disjoint union of the three similarly defined sets: T_T, T_S , and T_∞ .

Clearly the restriction of f to S_S is a bijection of S_S onto T_S .

Now let g^{-1} be the inverse function of the bijection g of T onto $g(T)$. Clearly the restriction of g^{-1} to S_T is a bijection of S_T onto T_T .

Finally, the restriction of f to S_∞ is a bijection of S_∞ onto T_∞ .

Define $h : S \rightarrow T$ by

$$h(s) = \begin{cases} f(s) & \text{if } s \in S_S \\ g^{-1}(s) & \text{if } s \in S_T \\ f(s) & \text{if } s \in S_\infty. \end{cases}$$

Then h is a bijection of S onto T . So S is equipotent to T . □

Our next task is to define what we mean by “cardinal number”.

A1.2.2 Definitions. A collection, \aleph , of sets is said to be a **cardinal number** if it satisfies the conditions:

- (i) Let S and T be sets. If S and T are in \aleph , then $S \sim T$;
- (ii) Let A and B be sets. If A is in \aleph and $B \sim A$, then B is in \aleph .

If \aleph is a cardinal number and A is a set in \aleph , then we write **card $A = \aleph$** .

Definitions A1.2.2 may, at first sight, seem strange. A cardinal number is defined as a collection of sets. So let us look at a couple of special cases:

If a set A has two elements we write $\text{card } A = 2$; the cardinal number 2 is the collection of all sets equipotent to the set $\{1, 2\}$, that is the collection of all sets with 2 elements.

If a set S is countable infinite, then we write $\text{card } S = \aleph_0$; in this case the cardinal number \aleph_0 is the collection of all sets equipotent to \mathbb{N} .

Let S and T be sets. Then S is equipotent to T if and only if $\text{card } S = \text{card } T$.

A1.2.3 Definitions. The cardinality of \mathbb{R} is denoted by **\mathfrak{c}** ; that is, $\text{card } \mathbb{R} = \mathfrak{c}$. The cardinality of \mathbb{N} is denoted by **\aleph_0** .

The symbol \mathfrak{c} is used in Definitions A1.2.3 as we think of \mathbb{R} as the “continuum”. We now define an ordering of the cardinal numbers.

A1.2.4 Definitions. Let m and n be cardinal numbers. Then the cardinal m is said to be less than or equal to n , that is **$m \leq n$** , if there are sets S and T such that $\text{card } S = m$, $\text{card } T = n$, and S is equipotent to a subset of T . Further, the cardinal m is said to be strictly less than n , that is **$m < n$** , if $m \leq n$ and $m \neq n$.

As \mathbb{R} has \mathbb{N} as a subset, $\text{card } \mathbb{R} = \mathfrak{c}$ and $\text{card } \mathbb{N} = \aleph_0$, and \mathbb{R} is not equipotent to \mathbb{N} , we immediately deduce the following result.

A1.2.5 Proposition. $\aleph_0 < \mathfrak{c}$. □

We also know that for any set S , S is equipotent to a subset of $\mathcal{P}(S)$, and S is not equipotent to $\mathcal{P}(S)$, from which we deduce the next result.

A1.2.6 Theorem. For any set S , $\text{card } S < \text{card } \mathcal{P}(S)$. □

The following is a restatement of the [Cantor-Schröder-Bernstein Theorem 1.2.1](#).

A1.2.7 Theorem. Let m and n be cardinal numbers. If $m \leq n$ and $n \leq m$, then $m = n$. □

A1.2.8 Remark. We observe that [there are an infinite number of infinite cardinal numbers](#). This is clear from the fact that:

$$(*) \quad \aleph_0 = \text{card } \mathbb{N} < \text{card } \mathcal{P}(\mathbb{N}) < \text{card } \mathcal{P}(\mathcal{P}(\mathbb{N})) < \dots \quad \square$$

The next result is an immediate consequence of [Theorem A1.2.6](#).

A1.2.9 Corollary. There is no largest cardinal number. □

Noting that if a finite set S has n elements, then its power set $\mathcal{P}(S)$ has 2^n elements, it is natural to introduce the following notation.

A1.2.10 Definition. If a set S has cardinality \aleph , then the cardinality of $\mathcal{P}(S)$ is denoted by 2^\aleph .

Thus we can rewrite $(*)$ above as:

$$(**) \quad \aleph_0 < 2^{\aleph_0} < 2^{2^{\aleph_0}} < 2^{2^{2^{\aleph_0}}} < \dots$$

When we look at this sequence of cardinal numbers there are a number of questions which should come to mind including:

- (1) Is \aleph_0 equal to one of the cardinal numbers on this list?
 (2) Are there any cardinal numbers strictly between \aleph_0 and 2^{\aleph_0} ?

These questions, especially (2), are not easily answered. Indeed they require a careful look at the axioms of set theory. It is not possible in this Appendix to discuss seriously the axioms of set theory. Nevertheless we will touch upon the above questions later in the appendix.

We conclude this section by identifying the cardinalities of a few more familiar sets.

A1.2.11 Lemma. Let a and b be real numbers with $a < b$. Then

- (i) $[0, 1] \sim [a, b]$;
- (ii) $(0, 1) \sim (a, b)$;
- (iii) $(0, 1) \sim (1, \infty)$;
- (iv) $(-\infty, -1) \sim (-2, -1)$;
- (v) $(1, \infty) \sim (1, 2)$;
- (vi) $\mathbb{R} \sim (-2, 2)$;
- (vii) $\mathbb{R} \sim (a, b)$.

Outline Proof. (i) is proved by observing that $f(x) = a + (b - a)x$ defines a one-to-one function of $[0, 1]$ onto $[a, b]$. (ii) and (iii) are similarly proved by finding suitable functions. (iv) is proved using (iii) and (ii). (v) follows from (iv). (vi) follows from (iv) and (v) by observing that \mathbb{R} is the union of the pairwise disjoint sets $(-\infty, -1)$, $[-1, 1]$ and $(1, \infty)$. (vii) follows from (vi) and (ii). \square .

A1.2.12 Proposition. Let a and b be real numbers with $a < b$. If S is any subset of \mathbb{R} such that $(a, b) \subseteq S$, then $\text{card } S = \mathfrak{c}$. In particular, $\text{card } (a, b) = \text{card } [a, b] = \mathfrak{c}$.

Proof. Using [Lemma A1.2.11](#) observe that

$$\text{card } \mathbb{R} = \text{card } (a, b) \leq \text{card } [a, b] \leq \text{card } \mathbb{R}.$$

So $\text{card } (a, b) = \text{card } [a, b] = \text{card } \mathbb{R} = \mathfrak{c}$. □.

A1.2.13 Proposition. If \mathbb{R}^2 is the set of points in the Euclidean plane, then $\text{card } (\mathbb{R}^2) = \mathfrak{c}$.

Outline Proof. By [Proposition A1.2.12](#), \mathbb{R} is equipotent to the half-open interval $[0, 1)$ and it is easily shown that it suffices to prove that $[0, 1) \times [0, 1) \sim [0, 1)$.

Define $f : [0, 1) \rightarrow [0, 1) \times [0, 1)$ by $f(x)$ is the point $\langle x, 0 \rangle$. Then f is a one-to-one mapping of $[0, 1)$ into $[0, 1) \times [0, 1)$ and so $\mathfrak{c} = \text{card } [0, 1) \leq \text{card } [0, 1) \times [0, 1)$.

By the [Cantor-Schröder-Bernstein Theorem A.2.1](#), it suffices then to find a one-to-one function g of $[0, 1) \times [0, 1)$ into $[0, 1)$. Define

$$g(\langle 0.a_1a_2 \dots a_n \dots, 0.b_1b_2 \dots b_n \dots \rangle) = 0.a_1b_1a_2b_2 \dots a_nb_n \dots$$

Clearly g is well-defined (as each real number in $[0, 1)$ has a unique decimal representation that does not end in $99 \dots 9 \dots$) and is one-to-one, which completes the proof. □

A1.3 Cardinal Arithmetic

We begin with a definition of addition of cardinal numbers. Of course, when the cardinal numbers are finite, this definition must agree with addition of finite numbers.

A1.3.1 Definition. Let α and β be any cardinal numbers and select disjoint sets A and B such that $\text{card } A = \alpha$ and $\text{card } B = \beta$. Then the **sum of the cardinal numbers α and β** is denoted by $\alpha + \beta$ and is equal to $\text{card } (A \cup B)$.

A1.3.2 Remark. Before knowing that the above definition makes sense and in particular does not depend on the choice of the sets A and B , it is necessary to verify that if A_1 and B_1 are disjoint sets and A and B are disjoint sets such that $\text{card } A = \text{card } A_1$ and $\text{card } B = \text{card } B_1$, then $A \cup B \sim A_1 \cup B_1$; that is, $\text{card}(A \cup B) = \text{card}(A_1 \cup B_1)$. This is a straightforward task and so is left as an exercise. \square

A1.3.3 Proposition. For any cardinal numbers α , β and γ :

- (i) $\alpha + \beta = \beta + \alpha$;
- (ii) $\alpha + (\beta + \gamma) = (\alpha + \beta) + \gamma$;
- (iii) $\alpha + 0 = \alpha$;
- (iv) If $\alpha \leq \beta$ then $\alpha + \gamma \leq \beta + \gamma$.

Proof. Exercise \square

A1.3.4 Proposition.

- (i) $\aleph_0 + \aleph_0 = \aleph_0$;
- (ii) $\mathfrak{c} + \aleph_0 = \mathfrak{c}$;
- (iii) $\mathfrak{c} + \mathfrak{c} = \mathfrak{c}$;
- (iv) For any finite cardinal n , $n + \aleph_0 = \aleph_0$ and $n + \mathfrak{c} = \mathfrak{c}$.

Proof.

- (i) The listing $1, -1, 2, -2, \dots, n, -n, \dots$ shows that the union of the two countably infinite sets \mathbb{N} and the set of negative integers is a countably infinite set.
- (ii) Noting that $[-2, -1] \cup \mathbb{N} \subset \mathbb{R}$, we see that $\text{card} [-2, -1] + \text{card } \mathbb{N} \leq \text{card } \mathbb{R} = \mathfrak{c}$. So $\mathfrak{c} = \text{card} [-2, -1] \leq \text{card} ([-2, -1] \cup \mathbb{N}) = \text{card} [-2, -1] + \text{card } \mathbb{N} = \mathfrak{c} + \aleph_0 \leq \mathfrak{c}$.
- (iii) Note that $\mathfrak{c} \leq \mathfrak{c} + \mathfrak{c} = \text{card} ((0, 1) \cup (1, 2)) \leq \text{card } \mathbb{R} = \mathfrak{c}$ from which the required result is immediate.
- (iv) Observe that $\aleph_0 \leq n + \aleph_0 \leq \aleph_0 + \aleph_0 = \aleph_0$ and $\mathfrak{c} \leq n + \mathfrak{c} \leq \mathfrak{c} + \mathfrak{c} = \mathfrak{c}$, from which the results follow. \square

Next we define multiplication of cardinal numbers.

A1.3.5 Definition. Let α and β be any cardinal numbers and select disjoint sets A and B such that $\text{card } A = \alpha$ and $\text{card } B = \beta$. Then the **product of the cardinal numbers α and β** is denoted by $\alpha\beta$ and is equal to $\text{card}(A \times B)$.

As in the case of addition of cardinal numbers, it is necessary, but routine, to check in [Definition A1.3.5](#) that $\alpha\beta$ does not depend on the specific choice of the sets A and B .

A1.3.6 Proposition. For any cardinal numbers α , β and γ

- (i) $\alpha\beta = \beta\alpha$;
- (ii) $\alpha(\beta\gamma) = (\alpha\beta)\gamma$;
- (iii) $1\alpha = \alpha$;
- (iv) $0\alpha = 0$;
- (v) $\alpha(\beta + \gamma) = \alpha\beta + \alpha\gamma$;
- (vi) For any finite cardinal n , $n\alpha = \alpha + \alpha + \dots + \alpha$ (n -terms);
- (vii) If $\alpha \leq \beta$ then $\alpha\gamma \leq \beta\gamma$.

Proof. Exercise

□

A1.3.7 Proposition.

- (i) $\aleph_0 \aleph_0 = \aleph_0$;
- (ii) $\mathfrak{c} \mathfrak{c} = \mathfrak{c}$;
- (iii) $\mathfrak{c} \aleph_0 = \mathfrak{c}$;
- (iv) For any finite cardinal n , $n \aleph_0 = \aleph_0$ and $n \mathfrak{c} = \mathfrak{c}$.

Outline Proof. (i) follows from [Proposition A1.1.16](#), while (ii) follows from [Proposition A1.2.13](#). To see (iii), observe that $\mathfrak{c} = \mathfrak{c} \cdot 1 \leq \mathfrak{c} \aleph_0 \leq \mathfrak{c} \mathfrak{c} = \mathfrak{c}$. The proof of (iv) is also straightforward. □

The next step in the arithmetic of cardinal numbers is to define exponentiation of cardinal numbers; that is, if α and β are cardinal numbers then we wish to define α^β .

A1.3.8 Definitions. Let α and β be cardinal numbers and A and B sets such that $\text{card } A = \alpha$ and $\text{card } B = \beta$. The set of all functions f of B into A is denoted by A^B . Further, α^β is defined to be $\text{card } A^B$.

Once again we need to check that the definition makes sense, that is that α^β does not depend on the choice of the sets A and B . We also check that if n and m are finite cardinal numbers, A is a set with n elements and B is a set with m elements, then there are precisely n^m distinct functions from B into A .

We also need to address one more concern: If α is a cardinal number and A is a set such that $\text{card } A = \alpha$, then we have two different definitions of 2^α . The above definition has 2^α as the cardinality of the set of all functions of A into the two point set $\{0, 1\}$. On the other hand, [Definition A1.2.10](#) defines 2^α to be $\text{card } (\mathcal{P}(A))$. It suffices to find a bijection θ of $\{0, 1\}^A$ onto $\mathcal{P}(A)$. Let $f \in \{0, 1\}^A$. Then $f: A \rightarrow \{0, 1\}$. Define $\theta(f) = f^{-1}(1)$. The task of verifying that θ is a bijection is left as an exercise.

A1.3.9 Proposition. For any cardinal numbers α , β and γ :

- (i) $\alpha^{\beta+\gamma} = \alpha^\beta \alpha^\gamma$;
- (ii) $(\alpha\beta)^\gamma = \alpha^\gamma \beta^\gamma$;
- (iii) $(\alpha^\beta)^\gamma = \alpha^{(\beta\gamma)}$;
- (iv) $\alpha \leq \beta$ implies $\alpha^\gamma \leq \beta^\gamma$;
- (v) $\alpha \leq \beta$ implies $\gamma^\alpha \leq \gamma^\beta$.

Proof. Exercise □

After [Definition A1.2.10](#) we asked three questions. We are now in a position to answer the second of these questions.

A1.3.10 Lemma. $\aleph_0^{\aleph_0} = \mathfrak{c}$.

Proof. Observe that $\text{card } \mathbb{N}^{\mathbb{N}} = \aleph_0^{\aleph_0}$ and $\text{card } (0, 1) = \mathfrak{c}$. As the function $f: (0, 1) \rightarrow \mathbb{N}^{\mathbb{N}}$ given by $f(0.a_1a_2 \dots a_n \dots) = \langle a_1, a_2, \dots, a_n, \dots \rangle$ is an injection, it follows that $\mathfrak{c} \leq \aleph_0^{\aleph_0}$.

By the [Cantor-Schröder-Bernstein Theorem A1.2.1](#), to conclude the proof it suffices to find an injective map g of $\mathbb{N}^{\mathbb{N}}$ into $(0, 1)$. If $\langle a_1, a_2, \dots, a_n, \dots \rangle$ is any element of $\mathbb{N}^{\mathbb{N}}$, then each $a_i \in \mathbb{N}$ and so we can write

$a_i = \dots a_{in} a_{i(n-1)} \dots a_{i2} a_{i1}$, where for some $M_i \in \mathbb{N}$, $a_{in} = 0$, for all $n > M_i$ [For example $187 = \dots 00 \dots 0187$ and so if $a_i = 187$ then $a_{i1} = 7$, $a_{i2} = 8$, $a_{i3} = 1$ and $a_{in} = 0$, for $n > M_i = 3$.] Then define the map g by

$$g(\langle a_1, a_2, \dots, a_n, \dots \rangle) = 0.a_{11}a_{12}a_{21}a_{13}a_{22}a_{31}a_{14}a_{23}a_{32}a_{41}a_{15}a_{24}a_{33}a_{42}a_{51}a_{16} \dots$$

(Compare this with the proof of [Lemma A1.1.13](#).)

Clearly g is an injection, which completes the proof. □

We now state a beautiful result, first proved by Georg Cantor.

A1.3.11 Theorem. $2^{\aleph_0} = \mathfrak{c}$.

Proof. Firstly observe that $2^{\aleph_0} \leq \aleph_0^{\aleph_0} = \mathfrak{c}$, by [Lemma A1.3.10](#). So we have to verify that $\mathfrak{c} \leq 2^{\aleph_0}$. To do this it suffices to find an injective map f of the set $[0, 1)$ into $\{0, 1\}^{\mathbb{N}}$. Each element x of $[0, 1)$ has a binary representation $x = 0.x_1x_2\dots x_n\dots$, with each x_i equal to 0 or 1. The binary representation is unique except for representations ending in a string of 1s; for example,

$$1/4 = 0.0100\dots 0\dots = 0.0011\dots 1\dots$$

Providing that in all such cases we choose the representation with a string of zeros rather than a string of 1s, the representation of numbers in $[0, 1)$ is unique. We define the function $f: [0, 1) \rightarrow \{0, 1\}^{\mathbb{N}}$ which maps $x \in [0, 1)$ to the function $f(x): \mathbb{N} \rightarrow \{0, 1\}$ given by $f(x)(n) = x_n$, $n \in \mathbb{N}$. To see that f is injective, consider any x and y in $[0, 1)$ with $x \neq y$. Then $x_m \neq y_m$, for some $m \in \mathbb{N}$. So $f(x)(m) = x_m \neq y_m = f(y)(m)$. Hence the two functions $f(x): \mathbb{N} \rightarrow \{0, 1\}$ and $f(y): \mathbb{N} \rightarrow \{0, 1\}$ are not equal. As x and y were arbitrary (unequal) elements of $[0, 1)$, it follows that f is indeed injective, as required. \square

A1.3.12 Corollary. If α is a cardinal number such that $2 \leq \alpha \leq \mathfrak{c}$, then $\alpha^{\aleph_0} = \mathfrak{c}$.

Proof. Observe that $\mathfrak{c} = 2^{\aleph_0} \leq \alpha^{\aleph_0} \leq \mathfrak{c}^{\aleph_0} = (2^{\aleph_0})^{\aleph_0} = 2^{\aleph_0 \cdot \aleph_0} = 2^{\aleph_0} = \mathfrak{c}$. \square

A1.4 Ordinal Numbers⁹

A1.4.1 Definitions. A partially ordered set (X, \leq) is said to be **linearly ordered** (or **totally ordered**) if every two elements are comparable. The order \leq is then said to be a **linear order** (or a **total order**.) The linear ordering is said to be a **strict linear ordering** (or a **strict total ordering**) if

$$a \leq b \text{ and } b \leq a \implies a = b, \text{ for } a, b \in X.$$

A1.4.2 Definitions. A strict totally ordered set (S, \leq) is said to be a **well-ordered set** if every non-empty subset of S has a least element. The total ordering is then said to be a **well-ordering**.

⁹For more detailed expositions of ordinal numbers see Abian [2], Ciesielski [83], Kamke [224], Roitman [344].

A1.4.3 Remark. Our next theorem says that every set can be well-ordered. While we call this a Theorem, it is equivalent to the [Axiom of Choice A6.1.26](#) and to [Zorn's Lemma 10.2.16](#). Usually we start set theory with the Zermelo-Fraenkel (ZF) Axioms. (See [Remark A6.1.26](#) and view my 3 videos on the Zermelo-Fraenkel Axioms:

Video 2a – <http://youtu.be/9h83ZJeiecg>,

Video 2b – <http://youtu.be/QPSRB4Fhzko>, &

Video 2c – <http://youtu.be/YvqUnjjQ3TQ>.)

In ZF, the Axiom of Choice cannot be proved. So the [Well-Ordering Theorem A1.2.4](#) cannot be proved in ZF. If we assume any one of the Axiom of Choice, Zorn's Lemma, or the Well-Ordering Theorem is true, then the other two can be proved. (For many equivalents of the Axiom of Choice, see Rubin and Rubin [348] and Rubin and Rubin [349].) If we add the Axiom of Choice to the Zermelo-Fraenkel Axioms, we get what is called ZFC. Many (but certainly not all) mathematicians work entirely within ZFC.

A1.4.4 Theorem. [Well-Ordering Theorem] Let S be any non-empty set. Then there exists a well-ordering \leq on S .

A1.4.5 Definitions. The partially ordered sets (X, \leq) and (Y, \preceq) are said to be **order isomorphic** (or have the **same order type**) if there is a bijection $f : X \rightarrow Y$ such that for $a, b \in X$, $a \leq b$ if and only if $f(a) \preceq f(b)$. The function f is said to be an **order isomorphism**.

A1.4.6 Proposition. Let (X, \leq) , (Y, \preceq) , and (Z, \ll) be partially ordered sets.

- (i) If $f : X \rightarrow Y$ is an order isomorphism, then the inverse function $f^{-1} : Y \rightarrow X$ is also an order isomorphism.
- (ii) If $f : X \rightarrow Y$ and $g : Y \rightarrow Z$ are order isomorphisms, then $g \circ f : X \rightarrow Z$ is also an order isomorphism.
- (iii) Let $f : X \rightarrow Y$ be an order isomorphism. If (X, \leq) is totally ordered, then (Y, \preceq) is totally ordered.
- (iv) Let $f : X \rightarrow Y$ be an order isomorphism. If (X, \leq) is well-ordered, then (Y, \preceq) is well-ordered.

Proof. Exercise. □

A1.4.7 Remark. We have indicated that we start with the ZF axioms of set theory. Next we need to define the natural numbers. We shall use induction. We begin by defining the number 0 as the empty set \emptyset . Then the number $1 = \{0\} = \{\emptyset\}$; the number $2 = \{0, 1\} = \{\emptyset, \{\emptyset\}\}$. Now using mathematical induction, we can define the number n to be $\{0, 1, 2, \dots, n-1\}$. Further, $\mathbb{N} = \{1, 2, \dots, n, \dots\}$. Thinking of the natural numbers as sets allows us to recognize that

- (i) n is well-ordered by \subseteq ;
- (ii) $n \notin n$;
- (iii) if $m \in n$, then $m \notin m$;
- (iv) if $m \in n$, then $m \subseteq n$.
- (v) if $m \in n$ and $p \in m$, then $p \in n$.

So with this in mind we see that each natural number n as well as \mathbb{N} is a set with a natural well-ordering.

This sets the stage for the definition of ordinal numbers first given by John von Neumann (1903-1957) in his 1923 paper, von Neumann [409]. See also von Neumann [410].

A1.4.8 Definition. A set α is said to be an **ordinal number** (or an **ordinal**) if it is the set of all ordinal numbers $\beta < \alpha$ well-ordered by \subseteq .

A1.4.9 Proposition. A set α is an ordinal number (or an **ordinal**) if and only if it has the following properties:

- (i) α is well-ordered by \subseteq ;
- (ii) $\alpha \notin \alpha$;
- (iii) if $\beta \in \alpha$, then $\beta \notin \beta$;
- (iv) if $\beta \in \alpha$, then $\beta \subseteq \alpha$;
- (v) if $\beta \in \alpha$ and $\gamma \in \beta$, then $\gamma \in \alpha$.

Proof. Exercise

□

A1.4.10 Remark. We see that each of the natural numbers $n \in \mathbb{N}$, regarded as a well-ordered set, is an ordinal number. Further, the definition of the set \mathbb{N} of all natural numbers satisfies [Definition A1.4.8](#) and so is an ordinal number, which will be denoted by ω .

A1.4.11 Remark. The relation \subseteq on an ordinal number is usually denoted by \leq . The relation $<$ is then clearly the same as \in .

We gather together in the next proposition several important results the proofs of which are straightforward.

A1.4.12 Proposition.

- (i) If α is an ordinal number and $\beta \in \alpha$, then β is also an ordinal number;
- (ii) for ordinal numbers α, β , if α is order isomorphic to β then $\alpha = \beta$;
- (iii) for ordinal numbers α, β , (a) $\alpha = \beta$ or (b) $\alpha < \beta$ or (c) $\beta < \alpha$;
- (iv) if \mathcal{S} is any non-empty set of ordinal numbers, then $\bigcup_{S_i \in \mathcal{S}} S_i$ is an ordinal number;
- (v) For every well-ordered set (S, \leq) , there exists exactly one ordinal number α that is order isomorphic to (S, \leq) .

Proof. Exercise. □

Now we shall define the sum and product of two ordinals α and β . In case α and β are not disjoint, for the sum we replace them by the equivalent sets $(\{0\} \times \alpha)$ and $(\{1\} \times \beta)$, then we define the ordering on the union of these two sets by keeping the original ordering on α and on β and making every element of α less than every element of β .

A1.4.13 Definitions. if α and β are ordinal numbers, then their **sum**, denoted by $\alpha + \beta$ is the order type of the well-ordered set

$$S = (\{0\} \times \alpha) \cup (\{1\} \times \beta)$$

ordered by $(i, \delta) \leq (j, \gamma)$ if and only if $i < j$ or $\delta \leq \gamma$.

The **product**, denoted by $\alpha\beta$ is the order type of the well-ordered set $\alpha \times \beta$ where the ordering is antilexicographic; that is,

$$(a, b) \leq (c, d) \text{ if and only if (i) } b < d \text{ or (ii) } b = d \text{ and } a \leq c.$$

A1.4.14 Remark. It is readily verified that **addition and multiplication of ordinal numbers is associative**; that is, for ordinal numbers α, β, γ , we have $\alpha + (\beta + \gamma) = (\alpha + \beta) + \gamma$ and $\alpha(\beta\gamma) = (\alpha\beta)\gamma$. However, **neither addition nor multiplication of ordinal numbers is commutative**. For example it is readily proved that

$$3 + \omega = \omega \neq \omega + 3 \quad \text{and} \quad \omega^2 = \omega + \omega \neq \omega = 2\omega.$$

The following table should prove helpful.

Sets	Ordinals
\emptyset	0
$\{0\}$	1
$\{0, 1\}$	2
$\{0, 1, 2\}$	3
...	...
$\{0, 1, 2, \dots, n, \dots\}$	ω
$\{0', 0, 1, 2, \dots, n, \dots\}$	$1 + \omega = \omega$
$\{0', 1', 2', \dots, (n' - 1), 0, 1, 2, \dots, n, \dots\}$	$n + \omega = \omega$
$\{0, 1, 0', 1', 0'', 1'', 0''', 1''', 0^{iv}, \dots\}$	$2\omega = \omega$
$\{0, 1, \dots, n, 0', 1', \dots, n', 0'', 1'', \dots, n'', 0''', 1''', \dots, n''', \dots\}$	$n\omega = \omega$
$\{0, 1, 2, \dots, n, \dots, 0'\}$	$\omega + 1 > \omega$
$\{0, 1, 2, \dots, n, \dots, 0', 1', \dots, \dots, (n' - 1)\}$	$\omega + n > \omega + 1 > \omega$
$\{0, 1, 2, \dots, n, \dots, 0', 1', 2', \dots, n', \dots\}$	$\omega + \omega > \omega + n$
$\{0, 1, \dots, n, \dots, 0', 1', \dots, n', \dots, 0'', 1'', \dots, n'', \dots, 0^{iv}, 1^{iv}, \dots, n^{iv}, \dots, \dots\}$	$\omega 2 > \omega + \omega > \omega$

A1.4.15 Remark. Every set of ordinal numbers is well-ordered by \leq .

A1.4.16 Definition. Let (S, \leq) be a partially ordered set. If $a \in S$, then the set of all elements $x \in S$ such that $x < a$ is said to be the **initial segment** of (S, \leq) determined by a .

A1.4.17 Remark. Every initial segment of an ordinal number is an ordinal number.

A1.4.18 Proposition. For any ordinal numbers α and β , precisely one of the following is true:

- (i) $\alpha = \beta$;
- (ii) α is an initial segment of β ;
- (iii) β is an initial segment of α .

Proof. Exercise. □

A1.4.19 Definitions. The **successor** of an ordinal number α , denoted by α^+ , is the smallest ordinal number β such that $\beta > \alpha$; that is $\alpha^+ = \alpha \cup \{\alpha\}$. The ordinal γ is said to be the **predecessor** of α , denoted by α^- , if α is the successor of γ . If $\alpha \neq 0$ and α has no predecessor, then it is said to be a **limit ordinal**.

A1.4.20 Remark. Clearly no finite ordinal is a limit ordinal. However ω is a limit ordinal. Of course the ordinal number $\omega + 1 = \omega^+$ and so $\omega + 1$ is not a limit ordinal. Indeed for each finite ordinal n , $\omega + n$ is not a limit ordinal, but $\omega + \omega$ is a limit ordinal.

A1.4.21 Proposition. If Γ is a set of ordinal numbers, then $\bigcup_{\gamma_i \in \Gamma} \gamma_i$ is an ordinal number and is the least upper bound of Γ that is, it is equal to $\sup \Gamma = \sup_{\gamma_i \in \Gamma} \gamma_i$.

If α is an ordinal number, then

- (i) $\bigcup_{\gamma_i \in \alpha} \gamma_i = \alpha$, if $\alpha = 0$ or α is a limit ordinal;
- (ii) $\bigcup_{\gamma_i \in \alpha} \gamma_i = \alpha^-$, if $\alpha \neq 0$ and α is not a limit ordinal.

Proof. Exercise. □

A1.4.22 Proposition. For every set Γ of ordinal numbers, there exists an ordinal number greater than every ordinal number in Γ .

Proof. Exercise. □

A1.4.23 Remark. The class of all ordinals is not a set, it is a proper class. □

A1.4.24 Remark. Now we turn to the notion of exponentiation of ordinal numbers; that is, for ordinal numbers α and β we wish to define the ordinal number α^β . This has to be done with considerable care in the case of infinite ordinals or the resulting set will not be well-ordered and so will not be an ordinal number.

A1.4.25 Definition. Let α and β be ordinal numbers. Let α^β be the set of all functions from the set β to the set α such that only a finite number of elements of the set β map to a non-zero member of the set α . Order the functions lexicographically as follows:

if $f, g \in \alpha^\beta$ then there exists a finite set $\{c_1 < c_2 < \dots < c_n\} \subseteq \beta$ such that for $b \in \beta$, $f(b) = 0$ and $g(b) = 0$ for $b \notin \{c_1, c_2, \dots, c_n\}$. Let c_i be the smallest member of $\{c_1, c_2, \dots, c_n\}$ such that $f(c_i) \neq g(c_i)$. Then define $f < g$ if $f(c_i) < g(c_i)$, otherwise define $g < f$.

A1.4.26 Remark. It needs to be checked that α^β as defined in [Definition A1.4.25](#) is indeed an ordinal number, and in particular is a well-ordered set. Without the finiteness restriction in the definition, this would not be the case.

A1.4.27 Theorem. [Transfinite Induction] Let $P(\gamma)$ be a proposition which is defined for all ordinals γ . If $P(0)$ is true and for each ordinal number α , $P(\beta)$ true for all $\beta < \alpha$ implies $P(\alpha)$ is true, then P is true for all ordinals.

A1.4.28 Proposition. If α and β are ordinal numbers, then

- (i) $\alpha^\beta = (\alpha^{\beta^-}) \alpha$ if $\beta > 0$ is not a limit ordinal;
- (ii) $\alpha^\beta = \sup_{\gamma < \beta} \alpha^\gamma$ if β is a limit ordinal and $\alpha > 0$.

Proof. Exercise.

A1.4.29 Remark. It is readily checked that

- (i) $\omega^2 = \omega \omega$;
- (ii) $\omega < \omega^2 < \dots < \omega^n$, for any natural number $n > 2$;
- (iii) $\omega^\omega = \sup_{n \in \omega} \omega^n$;
- (iv) $\omega < \omega^n < \omega^\omega$, for any natural number $n > 1$.

A1.4.30 Remark. Each of the ordinals $\omega, \omega^\omega, \omega^{\omega^\omega}, \dots$ is a countable ordinal; that is, each of the sets $\omega, \omega^\omega, \omega^{\omega^\omega}, \dots$ is a countable set. Further, the ordinal number ε_0 is defined to be $\sup\{\omega, \omega^\omega, \omega^{\omega^\omega}, \dots\}$ and it too is a countable ordinal. Clearly $\omega^{\varepsilon_0} = \varepsilon_0$. An ordinal number α which satisfies the equation $\omega^\alpha = \alpha$ are said to be an **ε -number**. The ordinal ε_0 is the smallest epsilon number. The next ordinal satisfying this equation is denoted by ε_1 and equals $\sup\{\varepsilon_0 + 1, \omega^{\varepsilon_0+1}, \omega^{\omega^{\varepsilon_0+1}}, \dots\}$. All the ε -numbers is also a countable ordinal.

Now we must of necessity be vague, because otherwise we would have to include quite a lot of deep material. (See Pohlers [327].) We can continue defining ordinals in a recursive way. The smallest ordinal which cannot be defined recursively in terms of smaller ordinals is called the **Church-Kleene ordinal** denoted by ω_1^{CK} . It too is a countable ordinal. The **first uncountable ordinal** is denoted ω_1 .

A1.4.31 Remark. How are cardinal numbers related to ordinal numbers? Every cardinal number is indeed an ordinal number. If we define $Z(\alpha)$ to consist of all the ordinal numbers $Z(\alpha)$ which are equipotent to the ordinal number α , we note that $Z(\alpha)$ is indeed a subset of the power set of the set α and so is a set. Further it has a smallest (or first) element, often called an **initial ordinal**. Each cardinal number is the initial ordinal of some ordinal α . We see that each cardinal number is a limit ordinal.

Having pointed out that ever cardinal number is an ordinal number, it is essential that we observe that **cardinal arithmetic is very different from ordinal arithmetic**. One need go no further than observing that the cardinal number \aleph_0 is the ordinal number ω . However, $\aleph_0^{\aleph_0}$ is uncountable, while ω^ω is countable. Ordinal addition and multiplication are not commutative while cardinal addition and cardinal multiplication are commutative.

We conclude this section by stating Cantor's Normal Form for ordinals.

A1.4.32 Proposition. [Cantor's Normal Form] Every ordinal number can be uniquely expressed in the form $\omega^{\beta_1}c_1 + \omega^{\beta_2}c_2 + \dots + \omega^{\beta_n}c_n$, where n is a natural number, c_1, c_2, \dots, c_n are positive integers, and $\beta_1 > \beta_2 > \dots \beta_n \geq 0$ are ordinal numbers.

A1.5 Credits for Images

1. Galileo Galilei: Public Domain.

Appendix 2: Topology Personalities

René Louis Baire	426
Stefan Banach	427
Luitzen Egbertus Jan Brouwer	428
Maurice Fréchet	430
Felix Hausdorff	431
Wacław Sierpiński	432
Credit for Images	434

The source for material extracted in this appendix is primarily *The MacTutor History of Mathematics Archive* [390], Bourbaki [51] and <http://en.wikipedia.org>. In fairness all of the material in this section should be treated as being essentially direct quotes from these sources, though I have occasionally changed the words slightly, and included here only the material that I consider pertinent to this book.

However, you might care to begin by reading the entertaining presentation by Barry Simon of California Institute of Technology entitled “Tales of our Forefathers” at <http://tinyurl.com/hr4cq3c>.

If you want to learn more about the History of Mathematics, you may care to watch some or all of the YouTube videos “Math History: A course in the history of mathematics” of Associate Professor Norman J. Wildberger of The University of New South Wales, Australia at <http://tinyurl.com/joelwmy>.

René-Louis Baire

René-Louis Baire was born in Paris, France in 1874. In 1905 he was appointed to the Faculty of Science at Dijon and in 1907 was promoted to Professor of Analysis. He retired in 1925 after many years of illness, and died in 1932. Reports on his teaching vary, perhaps according to his health: “Some described his lectures as very clear, but others claimed that what he taught was so difficult that it was beyond human ability to understand.”

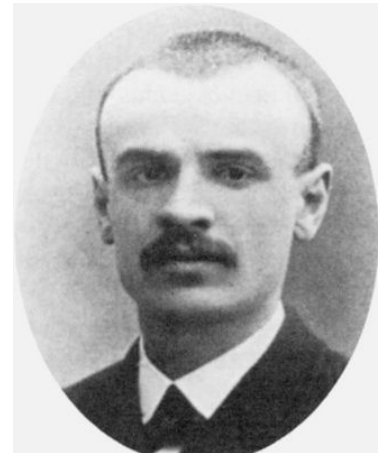

Baire

Stefan Banach

Stefan Banach was born in Ostrowsko, Austria-Hungary – now Poland – in 1892.

He lectured in mathematics at Lvov Technical University from 1920 where he completed his doctorate which is said to mark the birth of functional analysis. In his dissertation, written in 1920, he defined axiomatically what today is called a Banach space. The name 'Banach space' was coined by Fréchet. In 1924 Banach was promoted to full Professor. As well as continuing to produce a stream of important papers, he wrote textbooks in arithmetic, geometry and algebra for high school. Banach's Open Mapping Theorem of 1929 uses set-theoretic concepts which were introduced by Baire in his 1899 dissertation. The Banach-Tarski paradox appeared in a joint paper of the two mathematicians (Banach and Alfred Tarski) in 1926 in *Fundamenta Mathematicae* entitled *Sur la décomposition des ensembles de points en partiens respectivement congruent*. The puzzling paradox shows that a ball can be divided into subsets which can be fitted together to make two balls each identical to the first. The Axiom of Choice is needed to define the decomposition and the fact that it is able to give such a non-intuitive result has made some mathematicians question the use of the Axiom. The Banach-Tarski paradox was a major contribution to the work being done on axiomatic set theory around this period. In 1929, together with Hugo Dyonizy Steinhaus, he started a new journal *Studia Mathematica* and Banach and Steinhaus became the first editors. The editorial policy was ... to focus on research in functional analysis and related topics. The way that Banach worked was unconventional. He liked to do mathematical research with his colleagues in the cafés of Lvov. Stanislaw Ulam recalls frequent sessions in the Scottish Café (cf. Mauldin [278]): "It was difficult to outlast or outdrink Banach during these sessions. We discussed problems proposed right there, often with no solution evident even after several hours of thinking. The next day Banach was likely to appear with several small sheets of paper containing outlines of proofs he had completed." In

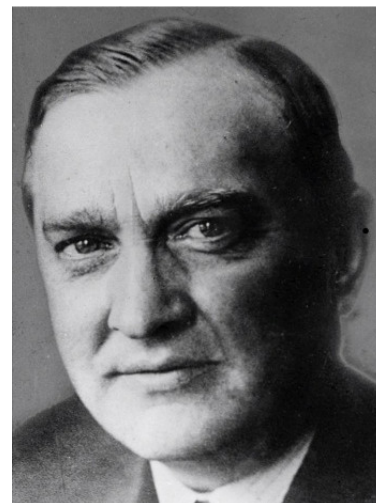

Banach

1939, just before the start of World War II, Banach was elected President of the Polish Mathematical Society. The Nazi occupation of Lvov in June 1941 meant that Banach lived under very difficult conditions. Towards the end of 1941 Banach worked feeding lice in a German institute dealing with infectious diseases. Feeding lice was to be his life during the remainder of the Nazi occupation of Lvov up to July 1944. Banach died in 1945.

Luitzen Egbertus Jan Brouwer

Luitzen Egbertus Jan Brouwer was born in 1881 in Rotterdam, The Netherlands. While an undergraduate at the University of Amsterdam he proved original results on continuous motions in four dimensional space. He obtained his Master's degree in 1904. Brouwer's doctoral dissertation, published in 1907, made a major contribution to the ongoing debate between Bertrand Russell and Jules Henri Poincaré on the logical foundations of mathematics. Brouwer quickly found that his philosophical ideas sparked controversy. Brouwer put a very large effort into studying various problems which he attacked because they appeared on David Hilbert's

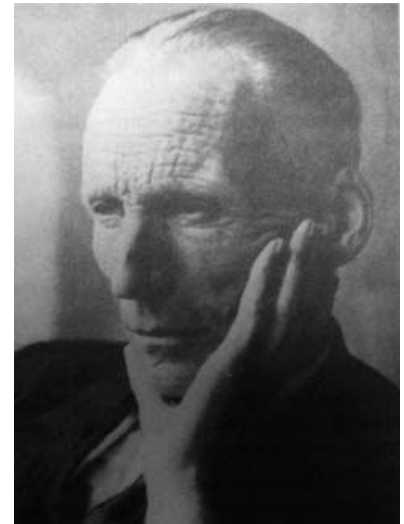

Brouwer

list of problems proposed at the Paris International Congress of Mathematicians in 1900. In particular Brouwer attacked Hilbert's fifth problem concerning the theory of Lie groups. He addressed the International Congress of Mathematicians in Rome in 1908 on the topological foundations of Lie groups. Brouwer was elected to the Royal Academy of Sciences in 1912 and, in the same year, was appointed extraordinary Professor of set theory, function theory and axiomatics at the University of Amsterdam; he would hold the post until he retired in 1951. Bartel Leendert van der Waerden, who studied at Amsterdam from 1919 to 1923, wrote about Brouwer as a lecturer: *Brouwer came [to the university] to give his courses but lived in Laren. He came only once a week. In general that would have not been permitted - he should have lived in Amsterdam - but for him an exception was made. ... I once interrupted him during a lecture to ask a question. Before the next week's lesson,*

his assistant came to me to say that Brouwer did not want questions put to him in class. He just did not want them, he was always looking at the blackboard, never towards the students. Even though his most important research contributions were in topology, Brouwer never gave courses on topology, but always on – and only on – the foundations of intuitionism. It seemed that he was no longer convinced of his results in topology because they were not correct from the point of view of intuitionism, and he judged everything he had done before, his greatest output, false according to his philosophy. As is mentioned in this quotation, Brouwer was a major contributor to the theory of topology and he is considered by many to be its founder. He did almost all his work in topology early in his career between 1909 and 1913. He discovered characterisations of topological mappings of the Cartesian plane and a number of fixed point theorems. His first fixed point theorem, which showed that an orientation preserving continuous one-one mapping of the sphere to itself always fixes at least one point, came out of his research on Hilbert's fifth problem. Originally proved for a 2-dimensional sphere, Brouwer later generalised the result to spheres in n dimensions. Another result of exceptional importance was proving the invariance of topological dimension. As well as proving theorems of major importance in topology, Brouwer also developed methods which have become standard tools in the subject. In particular he used simplicial approximation, which approximated continuous mappings by piecewise linear ones. He also introduced the idea of the degree of a mapping, generalised the Jordan curve theorem to n -dimensional space, and defined topological spaces in 1913. Van der Waerden, in the above quote, said that Brouwer would not lecture on his own topological results since they did not fit with mathematical intuitionism. In fact Brouwer is best known to many mathematicians as the founder of the doctrine of mathematical intuitionism, which views mathematics as the formulation of mental constructions that are governed by self-evident laws. His doctrine differed substantially from the formalism of Hilbert and the logicism of Russell. His doctoral thesis in 1907 attacked the logical foundations of mathematics and marks the beginning of the Intuitionist School. In his 1908 paper *The Unreliability of the Logical Principles* Brouwer rejected in mathematical proofs the Principle of the Excluded Middle, which states that any mathematical statement is either true or false. In 1918 he published a set theory developed without using the Principle of the Excluded Middle. He was made Knight

in the Order of the Dutch Lion in 1932. He was active setting up a new journal and he became a founding editor of *Compositio Mathematica* which began publication in 1934. During World War II Brouwer was active in helping the Dutch resistance, and in particular he supported Jewish students during this difficult period. After retiring in 1951, Brouwer lectured in South Africa in 1952, and the United States and Canada in 1953. In 1962, despite being well into his 80s, he was offered a post in Montana. He died in 1966 in Blaricum, The Netherlands as the result of a traffic accident.

Maurice Fréchet

Maurice Fréchet was born in France in 1878 and introduced the notions of metric space and compactness (see [Chapter 7](#)) in his dissertation in 1906. He held positions at a number of universities including the University of Paris from 1928–1948. His research includes important contributions to topology, probability, and statistics. He died in 1973.



Fréchet

Felix Hausdorff

One of the outstanding mathematicians of the first half of the twentieth century was **Felix Hausdorff**. He did groundbreaking work in topology, metric spaces, functional analysis, Lie algebras and set theory. He was born in Breslau, Germany – now Wrocław, Poland – in 1868. He graduated from, and worked at, University of Leipzig until 1910 when he accepted a Chair at the University of Bonn. In 1935, as a Jew, he was forced to leave his academic position there by the Nazi Nuremberg Laws. He continued to do research in mathematics for several years, but could publish his results only outside Germany. In 1942 he was scheduled to go to an internment camp, but instead he and his wife and sister committed suicide.



Hausdorff

Wacław Sierpiński

Wacław Sierpiński was born in 1882 in Warsaw, Russian Empire – now Poland. Fifty years after he graduated from the University of Warsaw, Sierpiński looked back at the problems that he had as a Pole taking his degree at the time of the Russian occupation: *... we had to attend a yearly lecture on the Russian language. ... Each of the students made it a point of honour to have the worst results in that subject. ... I did not answer a single question ... and I got an unsatisfactory mark. ... I passed all my examinations, then the lector suggested I should take a repeat examination, otherwise I would not be able to obtain the degree of a candidate for mathematical science. ... I refused him saying that this would be the first case at our University that someone having excellent marks in all subjects, having the dissertation accepted and a gold medal, would not obtain the degree of a candidate for mathematical science, but a lower degree, the degree of a 'real student' (strangely that was what the lower degree was called) because of one lower mark in the Russian language. Sierpiński was lucky for the lector changed the mark on his Russian language course to 'good' so that he could take his degree.* Sierpiński graduated in 1904 and worked as a school teacher of mathematics and physics in a girls' school. However when the school closed because of a strike, Sierpiński went to Kraków to study for his doctorate. At the Jagiellonian University in Kraków he received his doctorate and was appointed to the University of Lvov in 1908. In 1907 Sierpiński for the first time became interested in set theory. He happened across a theorem which stated that points in the plane could be specified with a single coordinate. He wrote to Tadeusz Banachiewicz asking him how such a result was possible. He received a one word reply (Georg) 'Cantor'. Sierpiński began to study set theory and in 1909 he gave the first ever lecture course devoted entirely to set theory. During the years 1908 to 1914, when he taught at the University of Lvov, he published three books in addition to many research papers. These books were *The theory of Irrational numbers* (1910), *Outline of Set Theory* (1912) and *The*



Sierpinski

Theory of Numbers (1912). When World War I began in 1914, Sierpiński and his family happened to be in Russia. Sierpiński was interned in Viatka. However Dimitri Feddrovich Egorov and Nikolai Nikolaevich Luzin heard that he had been interned and arranged for him to be allowed to go to Moscow. Sierpiński spent the rest of the war years in Moscow working with Luzin. Together they began the study of analytic sets. When World War I ended in 1918, Sierpiński returned to Lvov. However shortly after he was accepted a post at the University of Warsaw. In 1919 he was promoted to Professor spent the rest of his life there. In 1920 Sierpiński, together with his former student Stefan Mazurkiewicz, founded the important mathematics journal *Fundamenta Mathematica*. Sierpiński edited the journal which specialised in papers on set theory. From this period Sierpiński worked mostly in set theory but also on point set topology and functions of a real variable. In set theory he made important contributions to the axiom of choice and to the continuum hypothesis. He studied the Sierpiński curve which describes a closed path which contains every interior point of a square – a “space-filling curve”. The length of the curve is infinity, while the area enclosed by it is $5/12$ that of the square. Two fractals – Sierpiński triangle and Sierpiński carpet – are named after him. Sierpiński continued to collaborate with Luzin on investigations of analytic and projective sets. Sierpiński was also highly involved with the development of mathematics in Poland. In 1921 He had been honoured with election to the Polish Academy was made Dean of the faculty at the University of Warsaw. In 1928 he became Vice-Chairman of the Warsaw Scientific Society and, was elected Chairman of the Polish Mathematical Society. In 1939 life in Warsaw changed dramatically with the advent of World War II. Sierpiński continued working in the ‘Underground Warsaw University’ while his official job was a clerk in the council offices in Warsaw. His publications continued since he managed to send papers to Italy. Each of these papers ended with the words: *The proofs of these theorems will appear in the publication of Fundamenta Mathematica* which everyone understood meant ‘Poland will survive’. After the uprising of 1944 the Nazis burned his house destroying his library and personal letters. Sierpiński spoke of the tragic events of the war during a lecture he gave in 1945. He spoke of his students who had died in the war: *In July 1941 one of my oldest students Stanislaw Ruziewicz was murdered. He was a retired professor of Jan Kazimierz University in Lvov . . . an outstanding mathematician and an excellent teacher. In*

1943 one of my most distinguished students Stanislaw Saks was murdered. He was an Assistant Professor at Warsaw University, one of the leading experts in the world in the theory of the integral. . . In 1942 another student of mine was Adolf Lindenbaum was murdered. He was an Assistant Professor at Warsaw University and a distinguished author of works on set theory. After listing colleagues who were murdered in the war such as Juliusz Pawel Schauder and others who died as a result of the war such as Samuel Dickstein and Stanislaw Zaremba, Sierpiński continued: *Thus more than half of the mathematicians who lectured in our academic schools were killed. It was a great loss for Polish mathematics which was developing favourably in some fields such as set theory and topology . . . In addition to the lamented personal losses Polish mathematics suffered because of German barbarity during the war, it also suffered material losses. They burned down Warsaw University Library which contained several thousand volumes, magazines, mathematical books and thousands of reprints of mathematical works by different authors. Nearly all the editions of Fundamenta Mathematica (32 volumes) and ten volumes of Mathematical Monograph were completely burned. Private libraries of all the four Professors of mathematics from Warsaw University and also quite a number of manuscripts of their works and handbooks written during the war were burnt too.* Sierpiński was the author of the incredible number of 724 papers and 50 books. He retired in 1960 as Professor at the University of Warsaw but he continued to give a seminar on the theory of numbers at the Polish Academy of Sciences up to 1967. He also continued his editorial work, as Editor-in-Chief of Acta Arithmetica which he began in 1958, and as an editorial board member of Rendiconti dei Circolo Matimatico di Palermo, Compositio Mathematica and Zentralblatt für Mathematik. Andrzej Rotkiewicz, who was a student of Sierpiński's wrote: *Sierpiński had exceptionally good health and a cheerful nature. . . . He could work under any conditions.* Sierpiński died in 1969.

Credit for Images

1. René Louis Baire. Public Domain.
2. Stefan Banach. Copyright Hussein Abdulhakim. Creative Commons Licence.
https://en.wikipedia.org/wiki/Creative_Commons

3. Luitzen Egbertus Jan Brouwer. Public Domain.
4. Maurice Fréchet. Public Domain.
5. Felix Hausdorff. Public Domain.
6. Wacław Sierpiński. Public Domain.

Appendix 3: Chaos Theory and Dynamical Systems

§A3.0 Introduction	437
§A3.1 Iterates and Orbits	437
§A3.2 Fixed Points and Periodic Points	440
§A3.3 Phase Portraits, Attracting and Repelling Fixed Points	441
§A3.4 Graphical Analysis	444
§A3.5 Bifurcation	449
§A3.6 The Magic of Period 3: Period 3 Implies Chaos	455
§A3.7 Chaotic Dynamical Systems	460
§A3.8 Conjugate Dynamical Systems	466

§A3.0 Introduction

In this Appendix we give but a taste of dynamical systems and chaos theory. Most of the material is covered by way of exercises. Some parts of this Appendix require some knowledge of calculus. If you have not studied calculus¹⁰ you can skip this Appendix altogether or merely skim through it to get a flavour.

A3.1 Iterates and Orbits

A3.1.1 Definition. Let S be a set and f a function mapping the set S into itself; that is, $f: S \rightarrow S$. The functions $f^1, f^2, f^3, \dots, f^n, \dots$ are inductively defined as follows:

$f^1: S \rightarrow S$ is given by $f^1(x) = f(x)$; that is $f^1 = f$;

$f^2: S \rightarrow S$ is given by $f^2(x) = f(f(x))$; that is $f^2 = f \circ f$;

$f^3: S \rightarrow S$ is given by $f^3(x) = f(f(f(x)))$; that is, $f^3 = f \circ f \circ f = f \circ f^2$;

and if f^{n-1} is known then

$f^n: S \rightarrow S$ is defined by $f^n(x) = f(f^{n-1}(x))$; that is, $f^n = f \circ f^{n-1}$.

Each of the the functions $f^1, f^2, f^3, \dots, f^n, \dots$ is said to be an **iterate** of the function f .

Note that $f^{n+m} = f^n \circ f^m$, for $n, m \in \mathbb{N}$.

A3.1.2 Definitions. Let f be a function mapping the set S into itself. If $x_0 \in S$, then the sequence $x_0, f^1(x_0), f^2(x_0), \dots, f^n(x_0), \dots$ is called the **orbit** of the point x_0 . The point x_0 is called the **seed** of the orbit.

There are several possibilities for orbits, but the most important kind is a fixed point.

¹⁰If you would like to refresh your knowledge in this area, you might like to look at the classic book "A course of pure mathematics" by G.H. Hardy, which is available to download at no cost from Project Gutenberg at <http://www.gutenberg.org/ebooks/38769>.

A3.1.3 Definition. Let f be a mapping of a set S into itself. A point $a \in S$ is said to be a **fixed point** of f if $f(a) = a$.

A3.1.4 Example. Graphically, we can find all fixed points of a function $f: \mathbb{R} \rightarrow \mathbb{R}$, simply by sketching the curve $y = f(x)$ and seeing where it intersects the line $y = x$. At points of intersection, and only for these points, do we have $f(x) = x$.

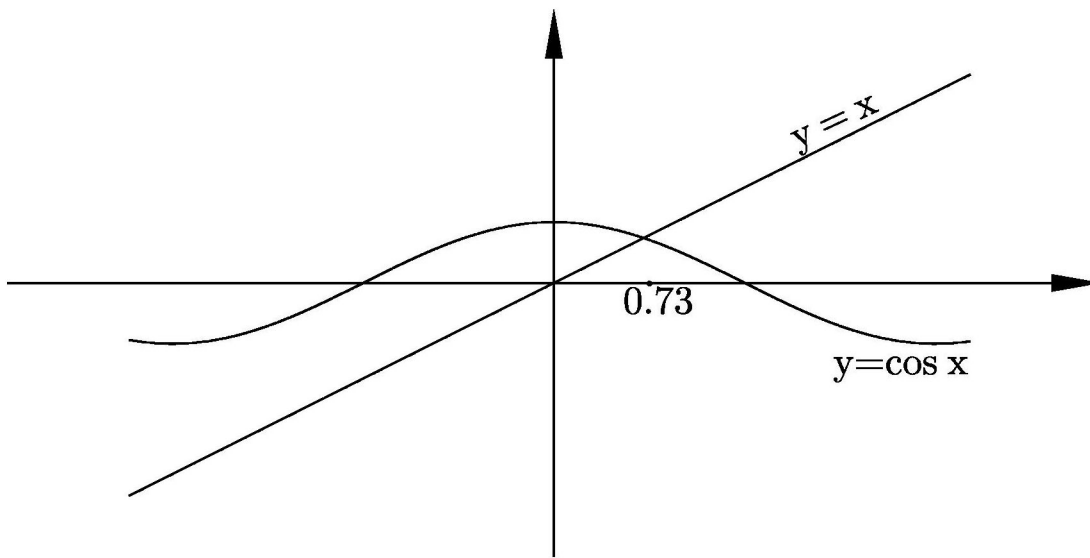

The fixed point of $f(x) = \cos x$ is $x = .739085133$ approximately

□

A3.1.5 Example.

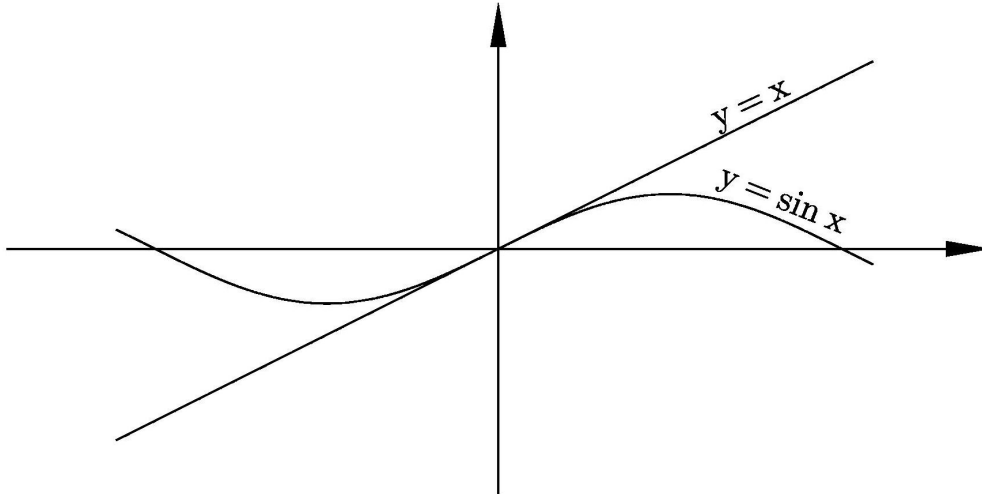

The fixed point of $f(x) = \sin x$ is $x = 0$

□

Exercises A3.1

1. Let the functions $f: \mathbb{R} \rightarrow \mathbb{R}$, $g: \mathbb{R} \rightarrow \mathbb{R}$ and $h: \mathbb{R} \rightarrow \mathbb{R}$ be given by $f(x) = x(1 - x)$, $g(x) = x \sin x$, and $h(x) = x^2 - 2$, for all $x \in \mathbb{R}$.
 - (a) Evaluate $f^1(x)$ and $f^2(x)$.
 - (b) Evaluate $g^2(x)$ and $g^2(1)$.
 - (c) Evaluate $h^2(x)$ and $h^3(x)$.
2. (a) If $C(x) = \cos(x)$, use your calculator [in radians to 4 decimal places] to compute $C^{10}(123)$, $C^{20}(123)$, $C^{30}(123)$, $C^{40}(123)$, $C^{50}(123)$, $C^{60}(123)$, $C^{70}(123)$, $C^{80}(123)$, $C^{90}(123)$, $C^{100}(123)$, $C^{100}(500)$ and $C^{100}(1)$. What do you notice?
 - (b) If $S(x) = \sin(x)$, use your calculator to compute $S^{10}(123)$, $S^{20}(123)$, $S^{30}(123)$, $S^{40}(123)$, $S^{50}(123)$, $S^{60}(123)$, $S^{70}(123)$, $S^{80}(123)$, $S^{90}(123)$, $S^{100}(123)$. What do you notice?

3. Let the function $h: \mathbb{R} \rightarrow \mathbb{R}$ be given by $h(x) = x^2$, for all $x \in \mathbb{R}$. Calculate the orbits for the function h of each of the following seeds: 0, 1, -1 , 0.5, 0.25.
4. Find all the fixed points of the function f in [Exercise 1 above](#).
5. Let $f: \mathbb{R} \rightarrow \mathbb{R}$ be given by $f(x) = x^3 - 3x$. Find all the fixed points of the function f .

A3.2 Fixed Points and Periodic Points

A3.2.1 Definition. Let f be a mapping of a set S into itself. A point $a \in S$ is said to be **eventually fixed** if a is not a fixed point, but some point on the orbit of a is a fixed point.

A3.2.2 Definitions. Let f be a function mapping the set S into itself. If $x \in S$, then the point $x \in S$ is said to be **periodic** if there exists a positive integer p such that $f^p(x) = x$. If m is the least $n \in \mathbb{N}$ such that $f^n(x) = x$, then m is called the **prime period** of x .

A3.2.3 Definition. Let f be a function mapping the set S into itself. Then the point $x_0 \in S$ is said to be **eventually periodic** if x_0 is not periodic itself, but some point in the orbit of x_0 is periodic.

A3.2.4 Remark. We have seen that points may be fixed, eventually fixed, periodic, or eventually periodic. However, it is important to realize that most points are not in any of these classes. □

Exercises A3.2

1. Verify that the point -1 is an eventually fixed point of $f(x) = x^2$.
2. Find the eventually fixed points of the function $f: \mathbb{R} \rightarrow \mathbb{R}$ given by $f(x) = |x|$.

3. If $f: \mathbb{R} \rightarrow \mathbb{R}$ is given by $f(x) = -\frac{3}{2}x^2 + \frac{5}{2}x + 1$, verify that $f(0) = 1$, $f(1) = 2$, and $f(2) = 0$, so that the orbit of 0 is $0, 1, 2, 0, 1, 2, \dots$. Hence 0 is a periodic point of prime period 3.
4. Prove that if x is a periodic point of prime period m of the function $f: S \rightarrow S$, then the orbit of x has precisely m points.
- [Hint: Firstly write down the orbit of the point x and then deduce that it has at most m points in it. Next suppose that there are fewer than m distinct points in the orbit of x and show that this leads to a contradiction to x having period m .]
5. Let $f: \mathbb{R} \rightarrow \mathbb{R}$ be given by $f(x) = x^2 - 1$. Verify that the points $\sqrt{2}$ and 1 are eventually periodic.
6. Consider the function $f: \mathbb{R} \rightarrow \mathbb{R}$ given by $f(x) = |1 - x|$.
- (i) Find all of the fixed points of f .
 - (ii) If m is an odd integer, what can you say about the orbit of m ?
 - (iii) If m is an even integer, what can you say about the orbit of m ?

A3.3 Phase Portraits, Attracting and Repelling Fixed Points

We wish to study dynamical systems, that is processes in motion. Such processes include for example the motion of planets, but other systems to which this theory is applied include the weather and population growth. Some even feel the study of dynamical systems will help us to understand stock market movements.

A very good method for depicting all orbits of a dynamical system is the phase portrait of the system. This is a picture on the real line of the orbits.

In the phase portrait we represent fixed points by **solid dots** and the dynamics along orbits by **arrows**.

A3.3.1 Example. If $f(x) = x^3$, then the fixed points are 0, 1, and -1 . If $|x_0| < 1$ then the orbit of x_0 is a sequence which tends to 0; we write this $f^n(x_0) \rightarrow 0$. If $|x_0| > 1$, then the orbit is a sequence which diverges to ∞ ; that is, $f^n(x_0) \rightarrow \pm\infty$. The phase portrait is given below:

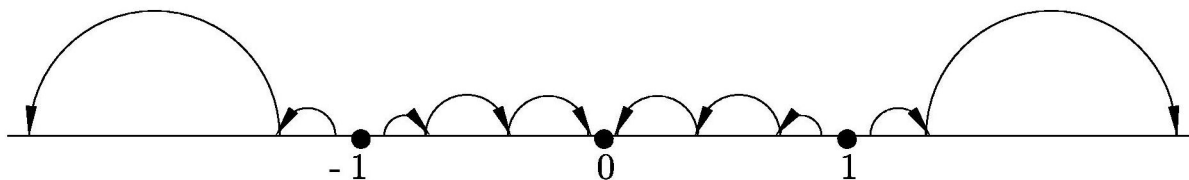

Phase portrait of $f(x) = x^3$

□

A3.3.2 Definition. Let a be a fixed point of the function $f: \mathbb{R} \rightarrow \mathbb{R}$. The point a is said to be an **attracting fixed point of f** if there is an open interval I containing a such that if $x \in I$, then $f^n(x) \rightarrow a$ as $n \rightarrow \infty$.

A3.3.3 Definition. Let a be a fixed point of the function $f: \mathbb{R} \rightarrow \mathbb{R}$. The point a is said to be a **repelling fixed point of f** if there is an open interval I containing a such that if $x \in I$ with $x \neq a$ then there is an integer n such that $f^n(x) \notin I$.

A3.3.4 Example. Observe that 0 is an attracting fixed point of $f(x) = x^3$, while -1 and 1 are repelling fixed points of this function. □

A3.3.5 Definition. A fixed point which is neither repelling nor attracting is called a **neutral fixed point**.

Exercises A3.3

1. Verify that the picture below is a correct phase portrait of $f(x) = x^2$ and identify whether the fixed points are repelling, attracting or neutral.

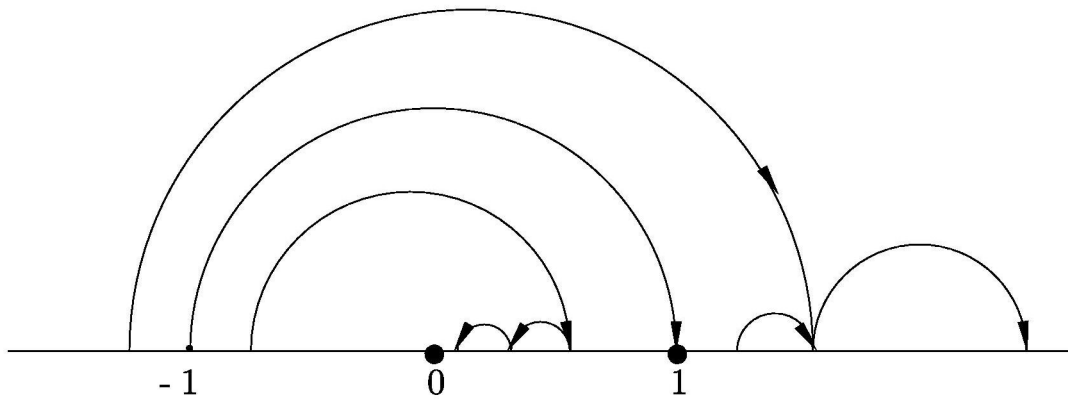

Phase portrait of $f(x) = x^2$

2. Do phase portraits for each of the following functions $f: \mathbb{R} \rightarrow \mathbb{R}$. Determine whether any fixed points are attracting, repelling or neutral.
- (i) $f(x) = -x^3$.
 - (ii) $f(x) = 4x$.
 - (iii) $f(x) = x - x^2$.
 - (iv) $f(x) = \sin x$.

3. Let $D: [0, 1) \rightarrow \mathbb{R}$ be the **doubling function** defined by

$$D(x) = \begin{cases} 2x, & 0 \leq x < \frac{1}{2} \\ 2x - 1, & \frac{1}{2} \leq x < 1. \end{cases}$$

[We could define D more succinctly by $D(x) = 2x \pmod{1}$.]

- (i) Verify that the point $\frac{1}{99}$ is a periodic point and find its prime period.
 - (ii) Explain why $\frac{1}{n}$ is either a periodic point or an eventually periodic point for each positive integer n .
 - (iii) Explain why $\frac{1}{2^n}$ is eventually fixed, for every positive integer n .
 - (iv) Write an explicit formula for $D^2(x)$ and $D^3(x)$, for $0 \leq x < 1$.
 - (v) Find all fixed points of D^2 and D^3 .
4. Do a phase portrait of the function $f(x) = 2x(1 - x)$. [This is an example of a so-called **logistic function** which arises naturally in the study of population growth and ecology.]

A3.4 Graphical Analysis

A3.4.1 Remark. We have used phase portraits to determine whether a point x_0 is fixed, periodic, eventually periodic etc. This method is particularly useful when we are dealing with more than one dimension. But for functions $f: \mathbb{R} \rightarrow \mathbb{R}$, we can use **graphical analysis**. This is done as follows.

Given a function $f: \mathbb{R} \rightarrow \mathbb{R}$, we are asked to determine the nature of the point $x_0 \in \mathbb{R}$. What we do is find the orbits of points a near to x_0 . We begin by sketching the function f and superimposing on its graph the graph of the line $y = x$.

To find the orbit of the point a , plot the point (a, a) . Next draw a vertical line to meet the graph of f at the point $(a, f(a))$. Then draw a horizontal line to meet the line $y = x$ at the point $f(a), f(a)$. Now draw a vertical line to meet the graph of f at the point $(f(a), f^2(a))$. Once again draw a horizontal line to meet the line $y = x$ at the point $(f^2(a), f^2(a))$. We continue this process and the points $a, f(a), f^2(a), f^3(a), \dots$ form the orbit of a . \square

A3.4.2 Example. We will now consider the function $f: \mathbb{R} \rightarrow \mathbb{R}$, given by $f(x) = x^4$. We sketch the curve $y = x^4$ and superimpose the line $y = x$. To find the fixed points we can solve $f(x) = x$; that is, solve $x^4 = x$.

It is readily seen that the fixed points are 0 and 1. We will consider points near each of these and do a graphical analysis, as described above, to find the orbits of points near 0 and near 1. The analysis in the diagram below shows what happens to points near to 1.

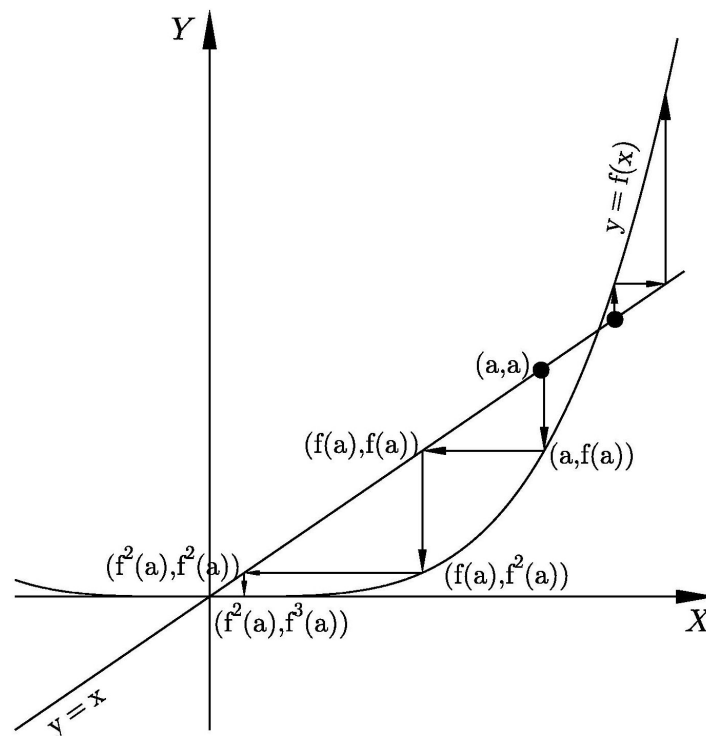

□

The next examples show graphical analyses of two more functions to indicate how different these can be for different functions. You will then get experience doing graphical analysis yourself.

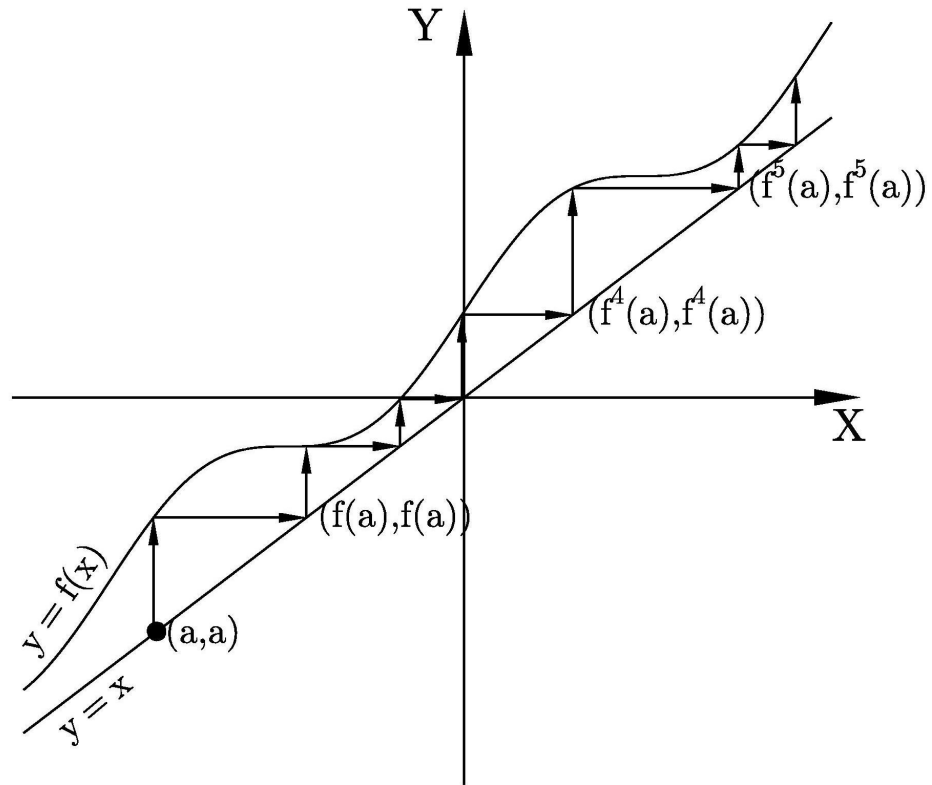
A3.4.3 Example.

In the above figure $f(x) = \sin x + x + 2$.

□

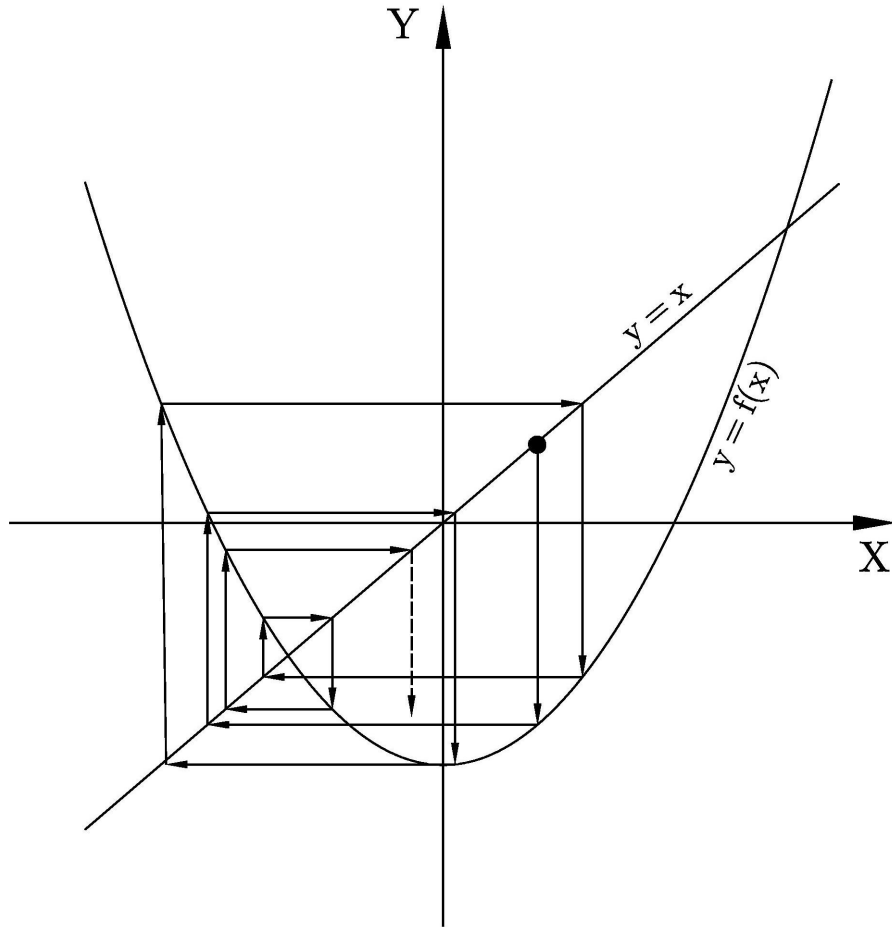
A3.4.4 Example.

In the above figure $f(x) = x^2 - 1.5$.

□

Exercises A3.4

1. Determine by graphical analysis whether each fixed point of $f(x) = x^4$ is an attracting fixed point, a repelling fixed point, or a neutral fixed point.
2. Use graphical analysis to describe the orbits of the function $f(x) = 2x$ and to determine the type of fixed point it has.
3. Find the fixed points of the function $f(x) = \sqrt{x}$ and use graphical analysis to determine their nature (that is, whether they are attracting, repelling, or neutral fixed points).
4. Use graphical analysis to describe the fate of all orbits of the function $f(x) = x - x^2$.
5. Use graphical analysis to describe the fate of all orbits of the function $f(x) = e^x$.
6. Let $f(x) = |x - 2|$. Use graphical analysis to display a variety of orbits of f . It may help to use different colours; for example, one colour for periodic orbits, another colour for eventually periodic orbits and yet another for eventually fixed orbits.
7. Let $D : [0, 1) \rightarrow [0, 1)$ be the doubling function given by $D(x) = 2x \bmod(1)$.
 - (i) Prove that $x \in [0, 1)$ is a rational number if and only if x is either a periodic point or an eventually periodic point of D .
 - (ii) Verify that the set of all periodic points of D is

$$P = \bigcup_{n=1}^{\infty} \left\{ 0, \frac{1}{2^n - 1}, \frac{2}{2^n - 1}, \frac{3}{2^n - 1}, \dots, \frac{2^n - 2}{2^n - 1} \right\}.$$

[Hint. It may be helpful to write down a formula for D^n and to calculate the points of intersection of the graph of D^n with the line $y = x$.]

- (iii) Verify that the set of periodic points of D is dense in $[0, 1)$. [We shall see that this is one of the two conditions required to show that the dynamical system $([0, 1), D)$ is chaotic.]

A3.5 Bifurcation

A3.5.1 Remark. It is natural to ask if every continuous function $f: S \rightarrow \mathbb{R}$ has a fixed point, where $S \subseteq \mathbb{R}$? The answer is easily seen to be **no**. For example, if $f: \mathbb{R} \rightarrow \mathbb{R}$ is given by $f(x) = x + 1$, then obviously there are no fixed points. Therefore it is remarkable that we can guarantee the existence of fixed points of **all** continuous functions of $[0, 1]$ into itself. More precisely, we have already seen and proved the following corollary:

5.2.11 Corollary. (Fixed Point Theorem) Let f be a continuous mapping of $[0, 1]$ into $[0, 1]$. Then there exists a $z \in [0, 1]$ such that $f(z) = z$.

Of course the above corollary does not help us to find the fixed point, rather it tells us only that at least one fixed point exists.

It would also be nice to have a simple way of establishing whether a particular fixed point is attracting, repelling, or neutral. For well-behaved functions [Theorems A3.5.2](#) and [A3.5.3](#) will be very useful in this regard. □

A3.5.2 Theorem. Let S be an interval in \mathbb{R} and a be a point in the interior of S . Further, let a be a fixed point of a function $f: S \rightarrow \mathbb{R}$. If f is differentiable at the point a and $|f'(a)| < 1$, then a is an attracting fixed point of f .

Proof. As $|f'(a)| < 1$, we have $|f'(a)| < k < 1$, where k is the positive real number given by $k = \frac{|f'(a)|+1}{2}$.

By definition, $f'(a) = \lim_{x \rightarrow a} \frac{f(x)-f(a)}{x-a}$. So for x “close enough” to a , we have $|\frac{f(x)-f(a)}{x-a}| \leq k$; more precisely, there exists an interval $I = [a - \delta, a + \delta]$, for some $\delta > 0$, such that $|\frac{f(x)-f(a)}{x-a}| \leq k$, for all $x \in I$ with $x \neq a$.

Since a is a fixed point, $f(a) = a$. So

$$|f(x) - a| \leq k|x - a|, \quad \text{for all } x \in I. \quad (1)$$

This implies that $f(x)$ is closer to a than x is, and so $f(x)$ is in I too. So we can repeat the same argument with $f(x)$ replacing x and obtain

$$|f^2(x) - a| \leq k|f(x) - a|, \quad \text{for all } x \in I. \quad (2)$$

From (1) and (2), we obtain

$$|f^2(x) - a| \leq k^2|x - a|, \quad \text{for all } x \in I. \quad (3)$$

Noting that $|k| < 1$ implies that $k^2 < 1$, we can repeat the argument again. By mathematical induction we obtain,

$$|f^n(x) - a| \leq k^n|x - a|, \quad \text{for all } x \in I \text{ and } n \in \mathbb{N}. \quad (4)$$

As $|k| < 1$, $\lim_{n \rightarrow \infty} k^n = 0$. By (4) this implies that $f^n(x) \rightarrow a$ as $n \rightarrow \infty$. And we have proved that a is an attracting fixed point. \square

The proof of [Theorem A3.5.3](#) is analogous to that of [Theorem A3.5.2](#) and so is left as an exercise.

A3.5.3 Theorem. Let S be an interval in \mathbb{R} and a an interior point of S . Further, let a be a fixed point of a function $f: S \rightarrow \mathbb{R}$. If f is differentiable at the point a and $|f'(a)| > 1$, then a is a repelling fixed point of f .

A3.5.4 Remark. It is important to note that [Theorem A3.5.2](#) and [Theorem A3.5.3](#) do not give necessary and sufficient conditions. Rather they say that if f' exists and $|f'(x)| < 1$ in an interval containing the fixed point a , then a is an attracting fixed point; and if $|f'(x)| > 1$ in an interval containing the fixed point a , then a is a repelling fixed point. If neither of these conditions is true we can say nothing! For example, it is possible that f is not differentiable at a but f still has an attracting fixed point at a . (This is the case, for example for $f(x) = \begin{cases} x^2 & \text{for } x \in \mathbb{Q} \\ -x^2 & \text{for } x \in \mathbb{R} \setminus \mathbb{Q}, \end{cases}$ which has 0 as an attracting fixed point.)

Even if f is differentiable at a , [Theorems A3.1.17](#) and [A3.1.18](#) tell us absolutely nothing if $f'(a) = 1$. Consider $f(x) = \sin x$. This function is differentiable at 0 with $f'(0) = \cos(0) = 1$. So [Theorems A3.1.17](#) and [A3.1.18](#) tell us nothing. However, 0 is an attracting fixed point of f . □

A3.5.5 Remark. One of the most important family of functions in this theory is the family of **quadratic maps** $Q_c: \mathbb{R} \rightarrow \mathbb{R}$, where $c \in \mathbb{R}$, and $Q_c(x) = x^2 + c$. For each different value of c we get a different quadratic function. But the surprising feature is that the dynamics of Q_c changes as c changes. The following theorem indicates this. We leave the proof of the theorem as an exercise.

A3.5.6 Theorem. (The First Bifurcation Theorem) Let Q_c be the quadratic function for $c \in \mathbb{R}$.

- (i) If $c > \frac{1}{4}$, then all orbits tend to infinity; that is, for all $x \in \mathbb{R}$, $(Q_c)^n(x) \rightarrow \infty$ as $n \rightarrow \infty$.
- (ii) If $c = \frac{1}{4}$, then Q_c has precisely one fixed point at $x = \frac{1}{2}$ and this is a neutral fixed point.
- (iii) If $c < \frac{1}{4}$, then Q_c has two fixed points $a_+ = \frac{1}{2}(1 + \sqrt{1 - 4c})$ and $a_- = \frac{1}{2}(1 - \sqrt{1 - 4c})$.
 - (a) The point a_+ is always repelling.
 - (b) If $-\frac{3}{4} < c < \frac{1}{4}$, then a_- is attracting.
 - (c) If $c < -\frac{3}{4}$, then a_- is repelling.

A3.5.7 Remark. The term **bifurcation** means a division into two. We see in the above theorem that for $c > \frac{1}{4}$ there are no fixed points; for $c = \frac{1}{4}$ there is precisely one fixed point; but for $c < \frac{1}{4}$ this fixed point splits into two — one at a_+ and one at a_- . We will say more about bifurcation presently.

A3.5.8 Definition. Let f be a function mapping the set S into itself. If the point $x \in S$ has prime period m , then the orbit of x is $\{x, f(x), \dots, f^{m-1}(x)\}$ and the orbit is called an **m -cycle**.

A3.5.9 Definitions. Let a be a periodic point of a function $f: S \rightarrow S$ of prime period m , for some $m \in \mathbb{N}$. [So a is clearly a fixed point of $f^m: S \rightarrow S$.] Then a is said to be an **attracting periodic point** of f if it is an attracting fixed point of f^m . Similarly a is said to be a **repelling periodic point** of f if it is a repelling fixed point of f^m .

The following theorem is left as an exercise.

A3.5.10 Theorem. (The Second Bifurcation Theorem) Let Q_c be the quadratic function for $c \in \mathbb{R}$.

- (a) If $-\frac{3}{4} \leq c < \frac{1}{4}$, then Q_c has no 2-cycles.
- (b) If $-\frac{5}{4} < c < -\frac{3}{4}$, then Q_c has an attracting 2-cycle, $\{q_-, q_+\}$, where $q_+ = \frac{1}{2}(-1 + \sqrt{-4c - 3})$ and $q_- = \frac{1}{2}(-1 - \sqrt{-4c - 3})$.
- (c) If $c < -\frac{5}{4}$, then Q_c has a repelling 2-cycle $\{q_-, q_+\}$.

A3.5.11 Remark. In The Second Bifurcation Theorem we saw a new kind of bifurcation called a **period doubling bifurcation**. As c decreases below $-\frac{3}{4}$, two things happen: the fixed point a_- changes from attracting to repelling and a new 2-cycle, $\{q_-, q_+\}$ appears. Note that when $c = -\frac{3}{4}$, we have $q_- = q_+ = -\frac{1}{2} = a_-$. So these two new periodic points originated at a_- when $c = -\frac{3}{4}$.

We will have more to say about period doubling bifurcations when we consider one-parameter families of functions (such as $Q_c: \mathbb{R} \rightarrow \mathbb{R}$, which depends on the parameter c , and the logistic functions $f_\lambda(x) = \lambda x(1 - x)$, which depend on the parameter λ). □

Exercises A3.5

1. Prove [Theorem A3.5.3](#).
2. Using [Theorems A3.5.2](#) and [A3.5.3](#) determine the nature of the fixed points of each of the following functions:
 - (i) $f_1(x) = 3x$.
 - (ii) $f_2(x) = \frac{1}{4x}$.
 - (iii) $f_3(x) = x^3$.
3. Prove [The First Bifurcation Theorem A3.5.6](#).

4. Let x be a periodic point of period 2 of the quadratic map Q_c . Prove that

(i) Prove that $x^4 + 2cx^2 - x + c^2 + c = 0$.

(ii) Why do the points $a_+ = \frac{1}{2}(1 + \sqrt{1 - 4c})$ and $a_- = \frac{1}{2}(1 - \sqrt{1 - 4c})$ satisfy the equation in (i)?

[Hint. Use [The First Bifurcation Theorem A3.5.6](#).]

(iii) Using (ii), show that if x is a periodic point of prime period 2 of Q_c , then $x^2 + x + c + 1 = 0$.

(iv) Deduce that if x is a periodic point of prime period 2, then x is one of the points

$$q_+ = \frac{1}{2}(-1 + \sqrt{-4c - 3}) \text{ and } q_- = \frac{1}{2}(-1 - \sqrt{-4c - 3}).$$

(v) Deduce that Q_c has a 2-cycle if and only if $c < -\frac{3}{4}$. [Be careful to eliminate the case $c = -\frac{3}{4}$.]

(vi) Using [Theorem A3.1.17](#) show that the quadratic function Q_c has q_- and q_+ as attracting periodic points if $|\frac{dQ_c^2(x)}{dx}| = |4x^3 + 4cx| < 1$ at $x = q_-$ and $x = q_+$.

(vii) Noting that q_- and q_+ both satisfy the equation $x^2 + x + c + 1 = 0$ (from (iii) and (iv) above), show that

$$4x^3 + 4cx = 4x(x^2 + c) = 4x(-1 - x) = 4(c + 1).$$

(viii) Using (vi), (vii), and (v) show that for $-\frac{5}{4} < c < -\frac{3}{4}$, q_+ and q_- are attracting periodic points of Q_c .

(ix) Similarly show that for $c < -\frac{5}{4}$, q_+ and q_- are repelling periodic points.

(x) Deduce the [Second Bifurcation Theorem A3.5.10](#) from what has been proved above in this exercise.

A3.6 The Magic of Period 3: Period 3 Implies Chaos

A3.6.1 Remark. In 1964, the Soviet mathematician A.N. Sarkovskii published the paper (Sarkovskii [356]) in Russian in a Ukrainian journal. There he proved a remarkable theorem which went unnoticed. In 1975 James Yorke and T-Y. Li published the paper (Yorke and Li [427]) in the *American Mathematical Monthly*. Even though the term “chaos” had previously been used in scientific literature, it was this paper that initiated the popularisation of the term. The main result of the paper, The Period Three Theorem, is astonishing, but is a very special case of Sarkovskii’s Theorem, proved a decade earlier. The discussion here of The Period Three Theorem is based on the presentation by Robert L. Devaney in his book (Devaney [101]).

A3.6.2 Theorem. (The Period Three Theorem) Let $f: \mathbb{R} \rightarrow \mathbb{R}$ be a continuous function. If f has a periodic point of prime period 3, then for each $n \in \mathbb{N}$ it has a periodic point of prime period n .

Proof. Exercises A3.6 #1–4.

□

A3.6.3 Remark. The Period Three Theorem is remarkable. But as stated earlier, a much more general result is true. It is known as Sarkovskii's Theorem. We shall not give a proof, but simply point out that the proof is of a similar nature to that above.

To state Sarkovskii's Theorem we need to order the natural numbers in the following curious way known as **Sarkovskii's ordering of the natural numbers**:

$$\begin{aligned}
 &3, 5, 7, 9, \dots \\
 &2 \cdot 3, 2 \cdot 5, 2 \cdot 7, \dots \\
 &2^2 \cdot 3, 2^2 \cdot 5, 2^2 \cdot 7, \dots \\
 &2^3 \cdot 3, 2^3 \cdot 5, 2^3 \cdot 7, \dots \\
 &\quad \vdots \\
 &\dots, 2^n, 2^{n-1}, \dots, 2^3, 2^2, 2^1, 1.
 \end{aligned}$$

A3.6.4 Theorem. (Sarkovskii's Theorem) Let $f: \mathbb{R} \rightarrow \mathbb{R}$ be a continuous function. If f has a periodic point of prime period n and n precedes k in Sarkovskii's ordering of the natural numbers, then f has a periodic point of prime period k .

A3.6.5 Remarks. (i) Firstly observe that as 3 appears first in Sarkovskii's ordering of the natural numbers, Sarkovskii's Theorem implies The Period Three Theorem.

- (ii) Secondly note that as the numbers of the form 2^n constitute the tail of Sarkovskii's ordering of the natural numbers, it follows that if f has only a finite number of periodic points, then they must all be of the form 2^n .
- (iii) Thirdly note that [Sarkovskii's Theorem](#) applies to continuous functions from \mathbb{R} into itself. If \mathbb{R} is replaced by other spaces the theorem may become false. However, \mathbb{R} can be replaced by any closed interval $[a, b]$. To see this let $f: [a, b] \rightarrow [a, b]$ be a continuous function. Then extend f to a continuous function $f': \mathbb{R} \rightarrow \mathbb{R}$ by defining $f'(x) = f(x)$, for $x \in [a, b]$; $f'(x) = f(a)$ if $x < a$; and $f'(x) = f(b)$, if $x > b$. Then the Theorem for f can be deduced from the Theorem for f' .

It is remarkable that the converse of Sarkovskii's Theorem is also true but we shall not prove it here. See (Dunn [116])

A3.6.6 Theorem. (Converse of Sarkovskii's Theorem) Let $n \in \mathbb{N}$ and l precede n in Sarkovskii's ordering of the natural numbers. Then there exists a continuous function $f: \mathbb{R} \rightarrow \mathbb{R}$ which has a periodic point of prime period n , but no periodic point of prime period l .

A3.6.7 Remark. From the [Converse of Sarkovskii's Theorem](#) it follows, for example, that there exists a continuous function of \mathbb{R} into itself which has a periodic point of prime period 6, and hence a periodic point of prime period of each even number, but no periodic point of odd prime period except 1.

Exercises A3.6

- Let f be a continuous mapping of an interval I into \mathbb{R} . Using [Propositions 4.3.5](#) and [5.2.1](#), prove that $f(I)$ is an interval.

2. Use the [Weierstrass Intermediate Value Theorem 5.2.9](#) to prove the following result:

Proposition A. *Let $a, b \in \mathbb{R}$ with $a < b$ and $f: I = [a, b] \rightarrow \mathbb{R}$ a continuous function. If $f(I) \supseteq I$, prove that f has a fixed point in I .*

[Hints. (i) Show that there exists points $s, t \in [a, b]$ such that $f(s) = c \leq a \leq s$ and $f(t) = d \geq b \geq t$.

(ii) Put $g(x) = f(x) - x$ and observe that g is continuous and $g(s) \leq 0$ and $g(t) \geq 0$.

(iii) Apply the [Weierstrass Intermediate Value Theorem](#) to g .]

3. Use the [Weierstrass Intermediate Value Theorem 5.2.9](#) to prove the following result:

Proposition B. *Let $a, b \in \mathbb{R}$ with $a < b$. Further, let $f: [a, b] \rightarrow \mathbb{R}$ be a continuous function and $f([a, b]) \supseteq J = [c, d]$, for $c, d \in \mathbb{R}$ with $c < d$. Prove that there is a subinterval $I' = [s, t]$ of $I = [a, b]$ such that $f(I') = J$.*

[Hints. (i) Verify that $f^{-1}(\{c\})$ and $f^{-1}(\{d\})$ are non-empty closed sets.

(ii) Using (i) and [Lemma 3.3.2](#) verify that there is a largest number s such that $f(s) = c$.

(ii) Consider the case that there is some $x > s$ such that $f(x) = d$. Verify that there is a smallest number such that $t > s$ and $f(t) = d$.

(iii) Suppose that there is a $y \in [s, t]$ such that $f(y) < c$. Use the Weierstrass Intermediate Value Theorem to obtain a contradiction.

(iv) Show also in a similar fashion that there is no $z \in [s, t]$ such that $f(z) > d$.

(v) Deduce that, under the condition in (ii), $f([s, t]) = [c, d] = J$, as required.

(vi) Now consider the case that there is no $x > s$ such that $f(x) = d$. Let s' be the largest number such that $f(s') = d$. Clearly $s' < s$. Let t' be the smallest number such that $t' > s'$ and $f(t') = c$. Verify that $f([s', t']) = [c, d] = J$, as required.]

4. Let f be as in [The Period Three Theorem A3.6.2](#). So there exists a point a in \mathbb{R} of prime period 3. So $f(a) = b$, $f(b) = c$, and $f(c) = a$, where $a \neq b$, $a \neq c$, and $b \neq c$. We shall consider the case $a < b < c$. The other cases are similarly handled. Put $I_0 = [a, b]$ and $I_1 = [b, c]$.

(i) Using [Exercise 1 above](#), verify that $f(I_0) \supseteq I_1$.

(ii) Using [Exercise 1 above](#) again, verify that $f(I_1) \supseteq I_0 \cup I_1$.

(iii) Deduce from (ii) and Proposition B above that there is a closed interval $A_1 \subseteq I_1$, such that $f(A_1) = I_1$.

(iv) Noting that $f(A_1) = I_1 \supseteq A_1$, use Proposition B above again to show there exists a closed interval $A_2 \subseteq A_1$ such that $f(A_2) = A_1$.

(v) Observe that $A_2 \subseteq A_1 \subseteq I_1$ and $f^2(A_2) = I_1$.

(vi) Use mathematical induction to show that for $n \geq 3$ there are closed intervals A_1, A_2, \dots, A_{n-2} such that

$$A_{n-2} \subseteq A_{n-3} \subseteq \dots \subseteq A_2 \subseteq A_1 \subseteq I_1$$

such that $f(A_i) = A_{i-1}$, $i = 2, \dots, n-2$, and $f(A_1) = I_1$.

(vii) Deduce from (vi) that $f^{n-2}(A_{n-2}) = I_1$ and $A_{n-2} \subseteq I_1$.

(viii) Noting that $f(I_0) \supseteq I_1 \supseteq A_{n-2}$, show that there is a closed interval $A_{n-1} \subseteq I_0$ such that $f(A_{n-1}) = A_{n-2}$.

(ix) Finally, using the fact that $f(I_1) \supseteq I_0 \supseteq A_{n-1}$, show that there is a closed interval $A_n \subseteq I_1$ such that $f(A_n) = A_{n-1}$.

(x) Putting the above parts together we see

$$A_n \xrightarrow{f} A_{n-1} \xrightarrow{f} \dots \xrightarrow{f} A_1 \longrightarrow I_1$$

with $f(A_i) = A_{i-1}$ and $f^n(A_n) = I_1$. Use the fact that $A_n \subseteq I_1$ and Proposition A to show that there is a point $x_0 \in A_n$ such that $f^n(x_0) = x_0$.

(xi) Observe from (x) that the point x_0 is a periodic point of f of period n . [We have yet to show that x_0 is of **prime** period n .]

(xii) Using the fact that $f(x_0) \in A_{n-1} \subseteq I_0$ and $f^i(x_0) \in I_1$, for $i = 2, \dots, n$, and $I_0 \cap I_1 = \{b\}$, show that x_0 is of prime period n . [Note the possibility that $f(x_0) = b$ needs to be eliminated. This can be done by observing that $f^3(x_0) \in I_1$, but $f^2(b) = a \notin I_1$.]

(xiii) From (xi) and (xii) and (vi), deduce that f has a periodic point of prime period n for every $n \geq 3$. [We deal with the cases $n = 1$ and $n = 2$ below.]

- (xiv) Use Proposition A and the fact that $f(I_1) \supseteq I_1$ to show there is a fixed point of f in I_1 ; that is there exists a periodic point of prime period 1.
- (xv) Note that $f(I_0) \supseteq I_1$ and $f(I_1) \supseteq I_0$. Using Proposition B show that there is a closed interval $B \subseteq I_0$ such that $f(B) = I_1$. Then, observe that $f^2(B) \supseteq I_0$, and from Proposition A, deduce that there exists a point $x_1 \in B$ such that $f^2(x_1) = x_1$. Verify that $x_1 \in B \subseteq I_0 = [a, b]$ while $f(x_1) \in f(B) = I_1 = [b, c]$ and $x_1 \neq b$. Deduce that x_1 is a periodic point of prime period 2 of f . This completes the proof of [The Period Three Theorem A3.6.2](#).

5. (i) Show that [The Period Three Theorem 3.6.2](#) would be false if \mathbb{R} were replaced by \mathbb{R}^2 .
[Hint. Consider a rotation about the origin.]
- (ii) Show that [The Period Three Theorem A3.6.2](#) would be false if \mathbb{R} were replaced by \mathbb{R}^n , $n \geq 2$.
- (iii) Show that [The Period Three Theorem A3.6.2](#) would be false if \mathbb{R} were replaced by S^1 , where S^1 is the circle centred at the origin of radius 1 in \mathbb{R}^2 .
6. Why is the [Sarkovskii Theorem A3.6.4](#) true when \mathbb{R} is replaced by the open interval (a, b) , for $a, b \in \mathbb{R}$ with $a < b$? [Hint. It's easy to deduce from Sarkovskii's Theorem for \mathbb{R} .]

A3.7 Chaotic Dynamical Systems

A3.7.1 Remarks. Today there are literally thousands of published research papers and hundreds of books dealing with chaotic dynamical systems. These are related to a variety of disciplines including art, biology, economics, ecology and finance. It would be folly to try to give a definitive history of chaos, a term used in the book of Genesis in the Bible and Hun-Tun (translated as chaos) in Taoism (Girardot [159]), a philosophical tradition dating back 2,200 years in China to the Han Dynasty. Here we focus on the twentieth century.

It would also be folly to try here to give the “correct” definition of the mathematical concept of chaos. Rather, we shall give one reasonable definition,

noting there are others which are inequivalent. Indeed some mathematicians assert that no existing definition captures precisely what we want chaos to be.

As stated earlier, the 1975 paper of Yorke and Li [427] triggered widespread interest in chaotic dynamical systems. However the previous year the Australian scientist Robert M. May, later Lord Robert May and President of the prestigious Royal Society of London published the paper [279] in which he stated **“Some of the simplest nonlinear difference equations describing the growth of biological populations with nonoverlapping generations can exhibit a remarkable spectrum of dynamical behavior, from stable equilibrium points, to stable cyclic oscillations between 2 population points, to stable cycles with 4, 8, 16, . . . points, through to a chaotic regime in which (depending on the initial population value) cycles of any period, or even totally aperiodic but bounded population fluctuations, can occur.”**

Jules Henri Poincaré (1854–1912), one of France’s greatest mathematicians, is acknowledged as one of the founders of a number of fields of mathematics including modern nonlinear dynamics, ergodic theory, and topology. His work laid the foundations for chaos theory. He stated in his 1903 book, a translated version of which was republished in 2003 (Poincarè [328]): **“If we knew exactly the laws of nature and the situation of the universe at its initial moment, we could predict exactly the situation of that same universe at a succeeding moment. But even if it were the case that the natural laws had no longer any secret for us, we could still only know the initial situation approximately. If that enabled us to predict the succeeding situation with the same approximation, that is all we require, and we should say that the phenomenon had been predicted, that it is governed by laws. But it is not always so; it may happen that small differences in the initial conditions produce very great ones in the final phenomena. A small error in the former will produce an enormous error in the latter. Prediction becomes impossible”**. What Poincaré described quite precisely has subsequently become known colloquially as the *butterfly effect*, an essential feature of chaos.

In 1952 Collier's magazine published a short story called "A Sound of Thunder" by the renowned author, Ray Bradbury (1920–2012). In the story, http://www.lasalle.edu/~didio/courses/hon462/hon462_assets/sound_of_thunder.htm a party of rich businessmen use time travel to journey back to a prehistoric era and go on a safari to hunt dinosaurs. However, one of the hunters accidentally kills a prehistoric butterfly, and this innocuous event dramatically changes the future world that they left. This was perhaps the incentive for a meteorologist's presentation in 1973 to the American Association for the Advancement of Science in Washington, D.C. being given the name "Predictability: Does the flap of a butterfly's wings in Brazil set off a tornado in Texas?" The meteorologist was Edward Norton Lorenz (1917–2008) and the flapping wing represented a tiny change in initial conditions causing enormous changes later. Lorenz discovered sensitivity to initial conditions by accident. He was running on a computer a mathematical model to predict the weather. Having run a particular sequence, he decided to replicate it. He re-entered the number from his printout, taken part-way through the sequence, and let it run. What he found was that the new results were radically different from his first results. Because his printout rounded to three decimal places, he had entered the number .506 than the six digit number .506127. Even so, he would have expected that the resulting sequence would differ only slightly from the original run. Since repeated experimentation proved otherwise, Lorenz concluded that the slightest difference in initial conditions made a dramatic difference to the outcome. So prediction was in fact impossible. Sensitivity to initial conditions, or the butterfly effect, had been demonstrated to be not just of theoretical importance but in fact of practical importance in meteorology. It was a serious limitation to predicting the weather – at least with that model. Perhaps this effect was evident also in a variety of other practical applications.

The American mathematicians George David Birkhoff (1884–1944) and Harold Calvin Marston Morse (1892–1977) continued Poincaré's work on dynamical systems. While Poincaré had made use of topology in the theory of dynamical systems, Birkhoff, in particular, supplemented this by the use of Lebesgue measure theory. In 1931 Birkhoff and P.A. Smith in their paper [43] introduced the concept of metric transitivity which is central in ergodic theory and was used by Robert L. Devaney in 1986 in his widely published definition of, and approach to, chaos.

The three conditions: transitivity, sensitivity to initial conditions, and density of periodic points as appeared in [The Period Three Theorem](#), were precisely what Devaney used in his definition of chaos. \square

A3.7.2 Definition. Let (X, d) be a metric space and $f: X \rightarrow X$ a mapping of the set X into itself. Then (X, f) is said to be a **dynamical system**.

A3.7.3 Remark. It would be much more appropriate to denote the dynamical system as (X, d, f) , however in the literature the convention is not do this.

A3.7.4 Definition. Let (X, d) be a metric space and $f: X \rightarrow X$ a mapping of X into itself. Then the dynamical system (X, f) is said to be **transitive** if given $x, y \in X$, and any $\varepsilon > 0$, there exists a $z \in X$ and an $n \in \mathbb{N}$, such that $d(z, y) < \varepsilon$ and $d(f^n(z), x) < \varepsilon$.

A3.7.5 Remark. Roughly speaking, transitivity says that there is a point z “close” to y such that some point in the orbit of z is “close” to x .

A3.7.6 Remark. At long last we shall define chaos. However, care needs to be taken as there is a number of inequivalent definitions of chaos in the literature as well as many writers who are vague about what they mean by chaos. Our definition is that used by Robert L. Devaney, with a modification resulting from the work of a group of Australian mathematicians, Banks et al. [31], in 1992.

A3.7.7 Definition. The dynamical system (X, f) is said to be **chaotic** if

- (i) the set of all periodic points of f is dense in the set X , and
- (ii) (X, f) is transitive.

A3.7.8 Remark. Until 1992 it was natural to add a third condition in the definition of chaotic dynamical systems. This condition is that in the dynamical system (X, f) , f depends sensitively on initial conditions. However in 1992 a group of mathematicians from La Trobe University in Melbourne, Australia proved that this condition is automatically true if the two conditions in [Definition A3.7.7](#) hold. Their work appeared in the paper "On Devaney's definition of chaos" by the authors John Banks, Gary Davis, Peter Stacey, Jeff Brooks and Grant Cairns in the American Mathematical Monthly (Banks et al. [31]). See also (Banks et al. [32]).

A3.7.9 Definition. The dynamical system (X, f) is said to **depend sensitively on initial conditions** if there exists a $\beta > 0$ such that for any $x \in X$ and any $\varepsilon > 0$ there exists $n \in \mathbb{N}$ and $y \in X$ with $d(x, y) < \varepsilon$ such that $d(f^n(x), f^n(y)) > \beta$.

A3.7.10 Remark. This definition says that no matter which x we begin with and how small a neighbourhood of x we choose, there is always a y in this neighbourhood whose orbit separates from that of x by at least β . [And β is independent of x .]

A3.7.11 Remark. What we said in [Remark A3.7.8](#) is that **every chaotic dynamical system depends sensitively on initial conditions**. We shall not prove this here. But we will show in [Exercises A3.7 #2](#) that the doubling map does indeed depend sensitively on initial conditions.

A3.7.12 Remark. In 1994, Michel Vellekoop and Raoul Berglund [402] proved that in the special case that (X, d) is a finite or infinite interval with the Euclidean metric, then transitivity implies condition (ii) in [Definition A3.7.7](#), namely that the set of all periodic points is dense. However, David Asaf and Steve Gadbois [213] showed this is not true for general metric spaces.

Exercises A3.7

1. Let $D: [0, 1) \rightarrow [0, 1)$ given by $D(x) = 2x \pmod{1}$ be the doubling map. Prove that the dynamical system $([0, 1), D)$ is chaotic.

[Hints. Recall that in [Exercises A3.4 #7](#) it was proved that the set of all periodic points of D is

$$P = \bigcup_{n=1}^{\infty} \left\{ 0, \frac{1}{2^n - 1}, \frac{2}{2^n - 1}, \frac{3}{2^n - 1}, \dots, \frac{2^n - 2}{2^n - 1} \right\}.$$

and that the set P is dense in $[0, 1)$. So condition (i) of [Definition A3.7.7](#) is satisfied. To verify condition (ii) use the following steps:

- (a) Let $x, y \in [0, 1)$ and $\varepsilon > 0$ be given. Let $n \in \mathbb{N}$ be such that $2^{-n} < \varepsilon$. For $k \in \{1, 2, \dots, n\}$, let

$$J_{k,n} = \left[\frac{k-1}{2^n}, \frac{k}{2^n} \right).$$

Show that there exists a $k \in \{1, 2, \dots, n\}$, such that $x \in J_{k,n}$.

- (b) Verify that $f^n(J_{k,n}) = [0, 1)$.
 (c) Deduce from (b) that there exists a $z \in J_{k,n}$ such that $f^n(z) = y$.
 (d) Deduce that z has the required properties of [Definition A3.7.4](#) and so $([0, 1), D)$ is a transitive dynamical system.
 (e) Deduce that $([0, 1), D)$ is a chaotic dynamical system.]

2. Prove that the doubling map of [Exercise 1 above](#) depends sensitively on initial conditions.

[Hints. Let $\beta = \frac{1}{4}$. Given any $\varepsilon > 0$, let $n \in \mathbb{N}$ be such that $2^{-n} < \varepsilon$. Put $s = f^n(x) + 0.251 \pmod{1}$. Firstly, verify that $d(f^n(x), s) > \beta$. As observed in [Exercise 1\(a\)](#), $x \in J_{k,n}$, for some $k \in \{1, 2, \dots, n\}$. But by [Exercise 1\(b\)](#), $f^n(J_{k,n}) = [0, 1)$. Let $y \in J_{k,n}$ be such that $f^n(y) = s$. Now verify that y has the required properties (i) $d(x, y) < \varepsilon$ and (ii) $d(f^n(x), f^n(y)) > \beta$.]

3. Let m be a (fixed) positive integer and consider the dynamical system $([0, 1), f_m)$ where $f_m(x) = mx \pmod{1}$. Prove that $([0, 1), f_m)$ is chaotic.

[Hint. See [Exercise 1 above](#).]

4. Let (X, \mathcal{T}) be a topological space and f a continuous mapping of X into itself. Then f is said to be **topologically transitive** if for any pair of non-empty open sets U and V in (X, \mathcal{T}) there exists an $n \in \mathbb{N}$ such that $f^n(U) \cap V \neq \emptyset$. For (X, d) a metric space and \mathcal{T} the topology induced by the metric d , prove that f is transitive if and only if it is topologically transitive.

A3.8 Conjugate Dynamical Systems

A3.8.1 Definition. Let (X_1, d_1) and (X_2, d_2) be metric spaces and (X_1, f_1) and (X_2, f_2) dynamical systems. Then (X_1, f_1) and (X_2, f_2) are said to be **conjugate dynamical systems** if there is a homeomorphism $h: (X_1, d_1) \rightarrow (X_2, d_2)$ such that $f_2 \circ h = h \circ f_1$; that is, $f_2(h(x)) = h(f_1(x))$, for all $x \in X_1$. The map h is called a **conjugate map**.

3A.8.2 Remark. In [Exercises A3.8 #2](#) it is verified that if (X_1, f_1) and (X_2, f_2) are conjugate dynamical systems, then (X_2, f_2) and (X_1, f_1) are conjugate dynamical systems. So we see that the order in which the dynamical systems are considered is of no importance. \square

A3.8.3 Remark. Conjugate dynamical systems are equivalent in the same sense that homeomorphic topological spaces are equivalent. The next theorem demonstrates this fact. Very often it will be possible to analyze a complex dynamical system by showing it is conjugate to one we already understand. \square

A3.8.4 Theorem. Let (X_1, f_1) and (X_2, f_2) be conjugate dynamical systems, where h is the conjugate map.

- (i) A point $x \in X_1$ is a fixed point of f_1 in X_1 if and only if $h(x)$ is a fixed point of f_2 in X_2 .
- (ii) A point $x \in X_1$ is a periodic point of period $n \in \mathbb{N}$ of f_1 in X_1 if and only if $h(x)$ is a periodic point of period n of f_2 in X_2 .
- (iii) The dynamical system (X, f_1) is chaotic if and only if the dynamical system (X, f_2) is chaotic.

Proof. (i) and (ii) are straightforward and left as exercises for you.

To see (iii), assume that (X_1, f_1) is chaotic. Let P be the set of periodic points of f_1 . As (X_1, f_1) is chaotic, P is dense in X_1 . As h is a continuous, it is easily seen that $h(P)$ is dense in the set $h(X_1) = X_2$. As $h(P)$ is the set of periodic points of (X_2, f_2) , it follows (X_2, f_2) satisfies condition (i) of [Definition A3.7.7](#).

To complete the proof, we need to show that (X_2, f_2) is transitive. To this end, let $\varepsilon > 0$ and $u, v \in X_2$. Then there are $x, y \in X_1$ such that $h(x) = u$ and $h(y) = v$. Since h is continuous, it is continuous at the points $x, y \in X_1$. Thus, there exists a $\delta > 0$ such that

$$z \in X_1 \quad \text{and} \quad d_1(x, z) < \delta \Rightarrow d_2(h(x), h(z)) < \varepsilon, \quad (12.1)$$

and

$$z' \in X_1 \quad \text{and} \quad d_1(y, z') < \delta \Rightarrow d_2(h(y), h(z')) < \varepsilon. \quad (12.2)$$

As (X_1, f_1) is transitive, there is a $z \in X_1$ and $n \in \mathbb{N}$, such that

$$d_1(x, z) < \delta \Rightarrow d_1(f_1^n(z), y) < \delta. \quad (12.3)$$

Let z be chosen so that (12.3) holds, and put $w = h(z)$. Using this value for z in (12.1), and taking $f_1^n(z)$ as z' in (12.2), we obtain

$$d_2(u, w) = d_2(h(x), h(z)) < \varepsilon, \quad \text{from (12.1) and (12.3)} \quad (12.4)$$

and

$$\begin{aligned} d_2(f_2^n(w), v) &= d_2(f_2^n(h(z)), h(y)), \\ &= d_2(h(f_1^n(z)), h(y)), \quad \text{as } h \circ f_1 = f_2 \circ h, \\ &< \varepsilon, \end{aligned} \quad (12.5)$$

from (2) and (3). Now from (12.4) and (12.5) it follows that (X_2, f_2) is transitive. \square

Exercises A3.8

1. Let $T: [0, 1] \rightarrow [0, 1]$ be the **tent function** given by

$$T(x) = \begin{cases} 2x, & \text{for } 0 \leq x \leq \frac{1}{2}, \\ 2 - 2x, & \text{for } \frac{1}{2} \leq x \leq 1. \end{cases}$$

- (i) Sketch the graph of T .
 - (ii) Calculate the formula for T^2 and sketch the graph of T^2 .
 - (iii) Calculate the formula for T^3 and sketch the graph of T^3 .
 - (iv) Let $I_{k,n} = [\frac{k-1}{2^n}, \frac{k}{2^n}]$, for $k \in \{1, 2, \dots, 2^n - 1\}$, $n \in \mathbb{N}$. Verify that $T^n(I_{k,n}) = [0, 1]$.
 - (v) Using Proposition A of Exercises 3.6 #2, show that T^n has a fixed point in each $I_{k,n}$.
 - (vi) Deduce from (v) that there is a periodic point of T in each $I_{k,n}$.
 - (vii) Using the above results show that $(T, [0, 1])$ is a chaotic dynamical system.
2. Verify that if (X_1, f_1) and (X_2, f_2) are conjugate dynamical systems then (X_2, f_2) and (X_1, f_1) are conjugate dynamical systems. (So the order in which the dynamical systems are considered is of no importance.)
3. Let $L: [0, 1] \rightarrow [0, 1]$ be the logistic function given by $L(x) = 4x(1 - x)$.
- (i) Show that the map $h: [0, 1] \rightarrow [0, 1]$ given by $h(x) = \sin^2(\frac{\pi}{2}x)$, is a homeomorphism of $[0, 1]$ onto itself such that $h \circ T = L \circ h$, where T is the tent function.
 - (ii) Deduce that $([0, 1], T)$ and $([0, 1], L)$ are conjugate dynamical systems.
 - (iii) Deduce from (ii), [Theorem A3.8.4](#) and [Exercise 1 above](#) that $([0, 1], L)$ is a chaotic dynamical system.
4. Consider the quadratic map $Q_{-2}: [-2, 2] \rightarrow [-2, 2]$, where $Q_{-2}(x) = x^2 - 2$.
- (i) Prove that the dynamical systems $([-2, 2], Q_{-2})$ and $([0, 1], L)$ of Exercise 3 above are conjugate.
 - (ii) Deduce that $([-2, 2], Q_{-2})$ is a chaotic dynamical system.

Appendix 4: Hausdorff Dimension

§A4.0 Introduction	470
§A4.1 Hausdorff Dimension	470

§A4.0 Introduction

In this section we introduce the notion of Hausdorff Dimension which plays an important role in the study of fractals.

A4.1 Hausdorff Dimension

We begin by warning the reader that this section is significantly more complicated than much of the material in the early chapters of this book. Further, an understanding of this section is not essential to the understanding of the rest of the book.

We think of points as 0-dimensional, lines as 1-dimensional, squares as 2-dimensional, cubes as 3-dimensional etc. So intuitively we think we know what the notion of dimension is. For arbitrary topological spaces there are competing notions of topological dimension. In “nice” spaces, the different notions of topological dimension tend to coincide. However, even the well-behaved euclidean spaces, \mathbb{R}^n , $n > 1$, have surprises in store for us.

In 1919 Felix Hausdorff [172] introduced the notion of Hausdorff dimension of a metric space. A surprising feature of Hausdorff dimension is that it can have values which are not integers. This topic was developed by Abram Samoilovitch Besicovitch [40] a decade or so later, but came into prominence in the 1970s with the work of Benoit Mandelbrot on what he called fractal geometry and which spurred the development of chaos theory. Fractals and chaos theory have been used in a very wide range of disciplines including economics, finance, meteorology, physics, and physiology.

We begin with a discussion of Hausdorff measure (or what some call Hausdorff-Besicovitch measure). Some readers will be familiar with the related notion of Lebesgue measure, however such an understanding is not essential here.

A4.1.1 Definition. Let Y be a subset of a metric space (X, d) . Then the number $\sup\{d(x, y) : x, y \in Y\}$ is said to be the **diameter** of the set Y and is denoted $\text{diam } Y$.

A4.1.2 Definition. Let Y be a subset of a metric space (X, d) , I an index set, ε a positive real number, and $\{U_i : i \in I\}$ a family of subsets of X such that $Y \subseteq \bigcup_{i \in I} U_i$ and, for each $i \in I$, $\text{diam } U_i < \varepsilon$. Then $\{U_i : i \in I\}$ is said to be an **ε -covering** of the set Y .

We are particularly interested in ε -coverings which are countable. So we are led to ask: which subsets of a metric space have countable ε -coverings for all $\varepsilon > 0$? The next Proposition provides the answer.

A4.1.3 Proposition. Let Y be a subset of a metric space (X, d) and d_1 the induced metric on Y . Then Y has a countable ε -covering for all $\varepsilon > 0$ if and only if (Y, d_1) is separable.

Proof. Assume that Y has a countable ε -covering for all $\varepsilon > 0$. In particular Y has a countable $(1/n)$ -covering, $\{U_{n,i} : i \in \mathbb{N}\}$, for each $n \in \mathbb{N}$. Let $y_{n,i}$ be any point in $Y \cap U_{n,i}$. We shall see that the countable set $\{y_{n,i} : i \in \mathbb{N}, n \in \mathbb{N}\}$ is dense in Y . Clearly for each $y \in Y$, there exists an $i \in \mathbb{N}$, such that $d(y, y_{n,i}) < 1/n$. So let O be any open set intersecting Y non-trivially. Let $y \in O \cap Y$. Then O contains an open ball B centre y of radius $1/n$, for some $n \in \mathbb{N}$. So $y_{n,i} \in O$, for some $i \in \mathbb{N}$. Thus $\{y_{n,i} : i \in \mathbb{N}, n \in \mathbb{N}\}$ is dense in Y and so Y is separable.

Conversely, assume that Y is separable. Then it has a countable dense subset $\{y_i : i \in \mathbb{N}\}$. Indeed, given any $y \in Y$ and any $\varepsilon > 0$, there exists a y_i , $i \in \mathbb{N}$, such that $d(y, y_i) < \varepsilon/2$. So the family of all $\{U_i : i \in \mathbb{N}\}$, where U_i is the open ball centre y_i and radius $\varepsilon/2$ is an ε -covering of Y , as required. \square

We are now able to define the Hausdorff s -dimensional measure of a subset of a metric space. More precisely, we shall define this measure for separable subsets of a metric space. Of course, if (X, d) is a separable metric space, such as \mathbb{R}^n , for any $n \in \mathbb{N}$, then all of its subsets are separable. (See [Exercises 6.3 #15.](#))

A4.1.4 Definition. Let Y be a separable subset of a metric space (X, d) and s a positive real number. For each positive real number $\varepsilon < 1$, put

$$\mathcal{H}_\varepsilon^s(Y) = \inf \left\{ \sum_{i \in \mathbb{N}} (\text{diam } U_i)^s : \{U_i : i \in \mathbb{N}\} \text{ is an } \varepsilon\text{-covering of } Y \right\}, \text{ and}$$

$$\mathcal{H}^s(Y) = \begin{cases} \lim_{\substack{\varepsilon \rightarrow 0 \\ \varepsilon > 0}} \mathcal{H}_\varepsilon^s(Y), & \text{if the limit exists;} \\ \infty, & \text{otherwise.} \end{cases}$$

Then $\mathcal{H}^s(Y)$ is said to be the **s -dimensional Hausdorff outer measure** of the set Y .

A4.1.5 Remark. Note that in [Definition A4.1.4](#), if $\varepsilon_1 < \varepsilon_2$, then $\mathcal{H}_{\varepsilon_1}^s(Y) \geq \mathcal{H}_{\varepsilon_2}^s(Y)$. So as ε tends to 0, either the limit of $\mathcal{H}_\varepsilon^s(Y)$ exists or it tends to ∞ . This helps us to understand the definition of $\mathcal{H}^s(Y)$. \square

A4.1.6 Remark. It is important to note that if d_1 is the metric induced on Y by the metric d on X , then $\mathcal{H}^s(Y)$ depends only on the metric d_1 on Y . In other words if Y is also a subset of the metric space (Z, d_2) and d_2 induces the same metric d_1 on Y , then $\mathcal{H}^s(Y)$ is the same when considered as a subset of (X, d) or (Y, d_2) . So, for example, the s -dimensional Hausdorff outer measure is the same for the closed interval $[0,1]$ whether considered as a subset of \mathbb{R} or of \mathbb{R}^2 or indeed of \mathbb{R}^n , for any positive integer n . \square

A4.1.7 Lemma. Let Y be a separable subset of a metric space (X, d) , s and t positive real numbers with $s < t$, and ε a positive real number < 1 . Then

- (i) $H_\varepsilon^t(Y) \leq H_\varepsilon^s(Y)$, and
- (ii) $H_\varepsilon^t(Y) \leq \varepsilon^{t-s} H_\varepsilon^s(Y)$.

Proof. Part (i) is an immediate consequence of the fact that $\varepsilon < 1$ and so each $\text{diam } U_i < 1$, which implies $(\text{diam } U_i)^t < (\text{diam } U_i)^s$. Part (ii) follows from the fact that $\text{diam } U_i < \varepsilon < 1$ and so $(\text{diam } U_i)^t < \varepsilon^{t-s} (\text{diam } U_i)^s$. \square

A4.1.8 Proposition. Let Y be a separable subset of a metric space (X, d) and s and t positive real numbers with $s < t$.

- (i) If $\mathcal{H}^s(Y) < \infty$, then $\mathcal{H}^t(Y) = 0$.
- (ii) If $0 \neq \mathcal{H}^t(Y) < \infty$, then $\mathcal{H}^s(Y) = \infty$.

Proof. These follow immediately from [Definition A4.1.3](#) and [Lemma A4.1.7ii](#). \square

A4.1.9 Remark. From [Proposition A4.1.8](#) we see that \square $\mathcal{H}^s(Y)$ is finite and non-zero for some value of s , then for all larger values of s , $\mathcal{H}^s(Y)$ equals 0 and for all smaller values of s , $\mathcal{H}^s(Y)$ equals ∞ . \square

[Proposition A4.1.8](#) allows us to define Hausdorff dimension.

A4.1.10 Definition. Let Y be a separable subset of a metric space (X, d) . Then

$$\dim_H(Y) = \begin{cases} \inf\{s \in [0, \infty) : \mathcal{H}^s(Y) = 0\}, & \text{if } \mathcal{H}^s(Y) = 0 \text{ for some } s > 0; \\ \infty, & \text{otherwise} \end{cases}$$

is called the **Hausdorff dimension** of the set Y .

We immediately obtain the following Proposition.

A4.1.11 Proposition. Let Y be a separable subset of a metric space (X, d) . Then

(i)
$$\dim_H(Y) = \begin{cases} 0, & \text{if } \mathcal{H}^s(Y) = 0 \text{ for all } s; \\ \sup\{s \in [0, \infty) : \mathcal{H}^s(Y) = \infty\}, & \text{if the supremum exists;} \\ \infty, & \text{otherwise.} \end{cases}$$

(ii)
$$\mathcal{H}^s(Y) = \begin{cases} 0, & \text{if } s > \dim_H(Y); \\ \infty, & \text{if } s < \dim_H(Y). \end{cases}$$

□

The calculation of the Hausdorff dimension of a metric space is not an easy exercise. But here is an instructive example.

A4.1.12 Example. Let Y be any finite subset of a metric space (X, d) . Then $\dim_H(Y) = 0$.

Proof. Put $Y = \{y_1, y_2, \dots, y_N\}$, $N \in \mathbb{N}$. Let $O_\varepsilon(i)$ be the open ball centre y_i and radius $\varepsilon/2$. Then $\{O_i : i = 1, \dots, N\}$ is an ε -covering of Y . So

$$\begin{aligned} \mathcal{H}_\varepsilon^s(Y) &= \inf \left\{ \sum_{i \in \mathbb{N}} (\text{diam } U_i)^s : \{U_i\} \text{ an open covering of } Y \right\} \\ &\leq \sum_{i=1}^N (\text{diam } O_i)^s = \varepsilon^s \cdot N^{s+1} / 2^s. \end{aligned}$$

Thus $\mathcal{H}^s(Y) \leq \lim_{\substack{\varepsilon \rightarrow 0 \\ \varepsilon > 0}} \varepsilon^s \cdot N^{s+1} / 2^s = 0$. So $\mathcal{H}^s(Y) = 0$, for all $s > 0$. Hence $\dim_H(Y) = 0$. □

The next Proposition is immediate.

A4.1.13 Proposition. If (Y_1, d_1) and (Y_2, d_2) are isometric metric spaces, then

$$\dim_H(Y_1) = \dim_H(Y_2).$$

A4.1.14 Proposition. Let Z and Y be separable subsets of a metric space (X, d) . If $Z \subset Y$, then $\dim_H(Z) \leq \dim_H(Y)$.

Proof. Exercise. □

A4.1.15 Lemma. Let $Y = \bigcup_{i \in \mathbb{N}} Y_i$ be a separable subset of a metric space (X, d) . Then

$$\mathcal{H}^s(Y) \leq \sum_{i=1}^{\infty} \mathcal{H}^s(Y_i).$$

Proof. Exercise. □

A4.1.16 Proposition. Let $Y = \bigcup_{i \in \mathbb{N}} Y_i$ be a separable subset of a metric space (X, d) . Then

$$\dim_H(Y) = \sup\{\dim_H(Y_i) : i \in \mathbb{N}\}.$$

Proof. It follows immediately from [Lemma A4.1.15](#) that

$$\dim_H(Y) \leq \sup\{\dim_H(Y_i) : i \in \mathbb{N}\}.$$

However, by [Proposition A4.1.14](#), $\dim_H(Y) \geq \dim_H(Y_i)$, for each $i \in \mathbb{N}$. Putting these two observations together completes the proof of the Proposition. □

A4.1.17 Proposition. If Y is a countable subset of a metric space (X, d) , then $\dim_H(Y) = 0$.

Proof. This follows immediately from [Proposition A4.1.16](#) and [Example A4.1.12](#) □

In particular, [Proposition A4.1.17](#) tells us that $\dim_H(\mathbb{Q}) = 0$.

A4.1.18 Example. Let $[a, a + 1]$, $a \in \mathbb{R}$ be a closed interval in \mathbb{R} , where \mathbb{R} has the euclidean metric. Then $\dim_H[a, a + 1] = \dim_H[0, 1] = \dim_H(\mathbb{R})$.

Proof. Let d_a be the metric induced on $[a, a + 1]$ by the euclidean metric on \mathbb{R} . Then $([a, a + 1], d_a)$ is isometric to $([0, 1], d_0)$, and so by [Proposition A4.1.13](#), $\dim_H[a, a + 1] = \dim_H[0, 1]$.

Now observe that $\mathbb{R} = \bigcup_{a=-\infty}^{\infty} [a, a + 1]$. So

$$\dim_H(\mathbb{R}) = \sup\{\dim_H[a, a + 1] : a = \dots, -n, \dots, -2, -1, 0, 1, 2, \dots, n, \dots\} = \dim_H[0, 1],$$

as each $\dim_H[a, a + 1] = \dim_H[0, 1]$. □

A4.1.19 Proposition. Let (X, d_1) and (Y, d_2) be separable metric spaces and $f : X \rightarrow Y$ a surjective function. If there exist positive real numbers a and b , such that for all $x_1, x_2 \in X$,

$$a \cdot d_1(x_1, x_2) \leq d_2(f(x_1), f(x_2)) \leq b \cdot d_1(x_1, x_2),$$

then $\dim_H(X, d_1) = \dim_H(Y, d_2)$.

Proof. Exercise □

A4.1.20 Remark. In some cases [Proposition A4.1.19](#) is useful in calculating the Hausdorff dimension of a space. See [Exercises 6.6 #7](#) and [#8](#).

Another useful device in calculating Hausdorff dimension is to refine the definition of the s -dimensional Hausdorff outer measure as in the following Proposition, where all members of the ε -covering are open sets.

A4.1.21 Proposition. Let Y be a separable subset of a metric space (X, d) and s a positive real number. If for each positive real number $\varepsilon < 1$,

$$\mathcal{O}_\varepsilon^s(Y) = \inf \left\{ \sum_{i \in \mathbb{N}} (\text{diam } O_i)^s : \{O_i : i \in \mathbb{N}\} \text{ is an } \varepsilon\text{-covering of } Y \text{ by open sets } O_i \right\}$$

then $\mathcal{O}_\varepsilon^s(Y) = \mathcal{H}_\varepsilon^s(Y)$.

$$\text{Further } \mathcal{H}^s(Y) = \begin{cases} \lim_{\varepsilon \rightarrow 0} \mathcal{O}_\varepsilon^s(Y), & \text{if the limit exists;} \\ \infty, & \text{otherwise.} \end{cases}$$

Proof. Exercise.

A4.1.22 Lemma. Let Y be a connected separable subset of a metric space (X, d) . If $\{O_i : i \in \mathbb{N}\}$ is a covering of Y by open sets O_i , then

$$\sum_{i \in \mathbb{N}} \text{diam } O_i \geq \text{diam } Y$$

Proof. Exercise. □

A4.1.23 Example. Show $\mathcal{H}^1[0, 1] \geq 1$.

Proof. If we put $Y = [0, 1]$ in [Lemma A4.1.22](#) and $s = 1$ in [Proposition A4.1.21](#), noting $\text{diam}[0, 1] = 1$ yields $\mathcal{H}_\varepsilon^1[0, 1] \geq 1$, for all $\varepsilon > 0$. This implies the required result. □

A4.1.24 Proposition. Let $[0, 1]$ denote the closed unit interval with the euclidean metric. Then $\dim_H[0, 1] = 1$.

Proof. From [Proposition A4.1.11](#), it suffices to show that $0 \neq \mathcal{H}^1[0, 1] < \infty$. This is the case if we show $\mathcal{H}^1[0, 1] = 1$.

For any $1 > \varepsilon > 0$, it is clear that the interval $[0, 1]$ can be covered by n_ε intervals each of diameter less than ε , where $n_\varepsilon \leq 2 + 1/\varepsilon$. So $\mathcal{H}_\varepsilon^1[0, 1] \leq \varepsilon(2 + 1/\varepsilon)$; that is, $\mathcal{H}_\varepsilon^1[0, 1] \leq 1 + 2\varepsilon$. Thus $\mathcal{H}^1[0, 1] \leq 1$. From [Example A4.1.23](#), we now have $\mathcal{H}^1[0, 1] = 1$, from which the Proposition follows. \square

A similar argument to that above shows that if $a, b \in \mathbb{R}$ with $a < b$, where \mathbb{R} has the euclidean metric, then $\dim_H[a, b] = 1$. The next Corollary includes this result and is an easy consequence of combining [Proposition A4.1.24](#), [Example A4.1.18](#), [Proposition A4.1.14](#), [Proposition 4.3.5](#), and the definition of totally disconnected in [Exercises 5.2 #10](#).

A4.1.25 Corollary. Let \mathbb{R} denote the set of all real numbers with the euclidean metric.

- (i) $\dim_H \mathbb{R} = 1$.
- (ii) If $S \subset \mathbb{R}$, then $\dim_H S \leq 1$.
- (iii) If S contains a non-trivial interval (that is, is not totally disconnected), then $\dim_H S = 1$.
- (iv) If S is a non-trivial interval in \mathbb{R} , then $\dim_H S = 1$.

Proof. Exercise \square

A4.1.26 Remark. In fact if \mathbb{R}^n has the euclidean metric, with $n \in \mathbb{N}$, then it is true that $\dim_H \mathbb{R}^n = n$. This is proved in [Exercises A4.1 #15](#). However, the proof there depends on the [Generalized Heine-Borel Theorem 8.3.3](#) which is not proved until [Chapter 8](#). \square

This appendix on Hausdorff dimension is not yet complete. From time to time please check for updates. \square

Exercises A4.1

1. Let Y be a subset of a metric space (X, d) and \bar{Y} its closure. Prove that $\text{diam } Y = \text{diam } \bar{Y}$.
2. Prove [Proposition A4.1.14](#).
[Hint. Use [Definitions A4.1.4](#) and [A4.1.10](#).]
3. Prove [Lemma A4.1.15](#).
4. If $Y = \bigcup_{i=1}^n Y_i$, for some $n \in \mathbb{N}$, is a separable subset of a metric space (X, d) , show that $\dim_H(Y) = \sup\{\dim_H(Y_i) : i = 1, 2, \dots, n\}$.
5. (i) Let $n \in \mathbb{N}$, and $a, b \in \mathbb{R}^n$. Show that if r and s are any positive real numbers, then the
open balls $B_r(a)$ and $B_s(b)$ in \mathbb{R}^n with the euclidean metric satisfy

$$\dim_H B_r(a) = \dim_H B_s(b).$$
- (ii) Using the method of [Example A4.1.18](#), show that $\dim_H B_r(a) = \dim \mathbb{R}^n$.
- (ii) If S_1 is the open cube $\{\langle x_1, x_2, \dots, x_n \rangle \in \mathbb{R}^n : 0 < x_i < 1, i = 1, \dots, n\}$, prove that $\dim_H S_1 = \dim_H \mathbb{R}^n$.
- (iii)* Using the method of [Proposition A4.1.24](#), show that if $n = 2$ then $\mathcal{H}^2(S_1) \leq 2$ and so $\dim_H(S_1) \leq 2$.
- (iv) Prove that $\dim_H \mathbb{R}^2 \leq 2$.
- (v)* Using an analogous argument, prove that $\dim_H \mathbb{R}^n \leq n$, for all $n > 2$.
6. Prove [Proposition A4.1.19](#).
[Hint. Prove that $a^s \cdot \mathcal{H}^s(X) \leq \mathcal{H}^s(Y) \leq b^s \cdot \mathcal{H}^s(X)$.]

7. Let $f: \mathbb{R} \rightarrow \mathbb{R}^2$ be the function given by $f(x) = \langle x, x^2 \rangle$. Using [Proposition A4.1.19](#), show that $\dim_H f[0, 1] = \dim_H[0, 1]$. Deduce from this and [Proposition A4.1.16](#) that if Y is the graph in \mathbb{R}^2 of the function $\theta: \mathbb{R} \rightarrow \mathbb{R}$ given by $\theta(x) = x^2$, then $\dim_H(Y) = \dim_H[0, 1]$.
8. Using an analogous argument to that in [Exercise 7 above](#), show that if Z is the graph in \mathbb{R}^2 of any polynomial $\phi(x) = a_n x^n + a_{n-1} x^{n-1} + \dots + a_2 x^2 + a_1 x + a_0$, where $a_n \neq 0$, then $\dim_H Z = \dim_H[0, 1]$.
- 9.* Let $g: \mathbb{R} \rightarrow \mathbb{R}$ be a function such that the n^{th} -derivative $g^{(n)}$ exists, for each $n \in \mathbb{N}$. Further assume that there exists a $K \in \mathbb{N}$, $|g^{(n)}(x)| < K$, for all $n \in \mathbb{N}$ and all $x \in [0, 1]$. (Examples of such functions include $g = \exp$, $g = \sin$, $g = \cos$, and g is a polynomial.) Using the Taylor series expansion of g , extend the method of [Exercises 7 and 8 above](#) to show that if $f: \mathbb{R} \rightarrow \mathbb{R}^2$ is given by $f(x) = \langle x, g(x) \rangle$, then $\dim_H f[0, 1] = \dim_H[0, 1]$.
10. Prove [Proposition A4.1.21](#).
[Hint. Firstly prove that if z is any positive real number greater than 1, and U_i is any set in (X, d) of diameter less than ε , then there exists an open set O_i such that (i) $U_i \subseteq O_i$, (ii) $\text{diam } O_i < \varepsilon$, and (iii) $\text{diam } O_i \leq z \cdot \text{diam } U_i$. Use this to show that $\mathcal{O}_\varepsilon^s(Y) \leq z^s \cdot \mathcal{H}_\varepsilon^s(Y)$, for all $z > 1$.]
11. Prove [Lemma A4.1.22](#).
[Hint. First assume that Y is covered by 2 open sets and prove the analogous result. Then consider the case that Y is covered by a finite number of open sets. Finally consider the case of an infinite covering remembering a sum of an infinite number of terms exists (and is finite) if and only if the limit of the finite sums exist.]
12. Show that if \mathbb{P} denotes the set of all irrational numbers with the euclidean metric, then $\dim_H \mathbb{P} = 1$
13. Fill in the details of the proof of [Corollary A4.1.25](#).

14. The [Generalized Heine-Borel Theorem 8.3.3](#) proved in [Chapter 8](#), implies that if $\{O_i : i \in \mathbb{N}\}$ is an ε -covering of the open cube S_1 of [Example 5](#) above, then there exists an $N \in \mathbb{N}$, such that $\{O_1, O_2, \dots, O_N\}$ is also an ε -covering of S_1 . Using this, extend [Proposition A4.1.21](#) to say that: For every positive real number ε ,

$$\mathcal{H}_\varepsilon^s(S_1) = \inf \left\{ \sum_{i=1}^N (\text{diam } O_i)^s \right\}$$

where $N \in \mathbb{N}$ and O_1, \dots, O_N is an open ε covering of S_1 .

Warning: Note that this Exercise depends on a result not proved until [Chapter 8](#).

15. (i) Show that if O is a subset of \mathbb{R}^2 with the euclidean metric, and A is its area,

$$\text{then } A \leq \frac{\pi}{4} \cdot (\text{diam } O)^2.$$

- (ii) Deduce from (i) that if O_1, O_2, \dots, O_N is an ε -covering of S_1 in \mathbb{R}^2 of [Example 5](#) above, then

$$\sum_{i=1}^N (\text{diam } O_i)^2 \geq \frac{4}{\pi}.$$

- (iii) Deduce from (ii) and Exercise 14 above that $\mathcal{H}^2(S_1) \geq \frac{4}{\pi}$.
- (iv) Using (iii) and [Exercise 5](#), prove that $\dim_H(S_1) = \dim_H \mathbb{R}^2 = 2$.
- (v) Using an analogous method to that above, prove that $\dim_H \mathbb{R}^n = n$, where \mathbb{R}^n has the euclidean metric.
- (vi) Prove that if S is any subset of \mathbb{R}^n with the euclidean metric, such that S contains a non-empty open ball in \mathbb{R}^n , the $\dim_H S = n$.

Warning: Note that (iii), (iv), (v), and (vi) of this Exercise depend on a result proved in [Chapter 8](#).

Appendix 5: Topological Groups: A Graduate Course

Contents of Appendix 5: Topological Groups

§A5.0 Introduction	484
§A5.1 Topological Groups	512
§A5.2 Subgroups and Quotient Groups of Topological Groups	519
§A5.3 Embedding in Divisible Groups	529
§A5.4 Baire Category and Open Mapping Theorems	534
§A5.5 Subgroups and Quotient Groups of \mathbb{R}^n	537
§A5.6 Uniform Spaces	550
§A5.7 Dual Groups	556
§A5.8 Pontryagin–van Kampen Duality Theorem: Introduction	562
§A5.9 Dual Groups of Subgroups, Quotients, and Finite Products	565
§A5.10 Peter-Weyl Theorem	571
§A5.11 The Duality Theorem for Compact Groups and Discrete Groups	574
§A5.12 Monothetic LCA-groups and Compactly Generated LCA-groups	580
§A5.13 The Duality Theorem and the Principal Structure Theorem	590
§A5.14 Consequences of the Duality Theorem Part One: Kronecker’s Theorem	601
§A5.15 Consequences of the Duality Theorem Part Two: Connected and Totally Disconnected LCA-Groups	607
§A5.99 Credit for Images	??

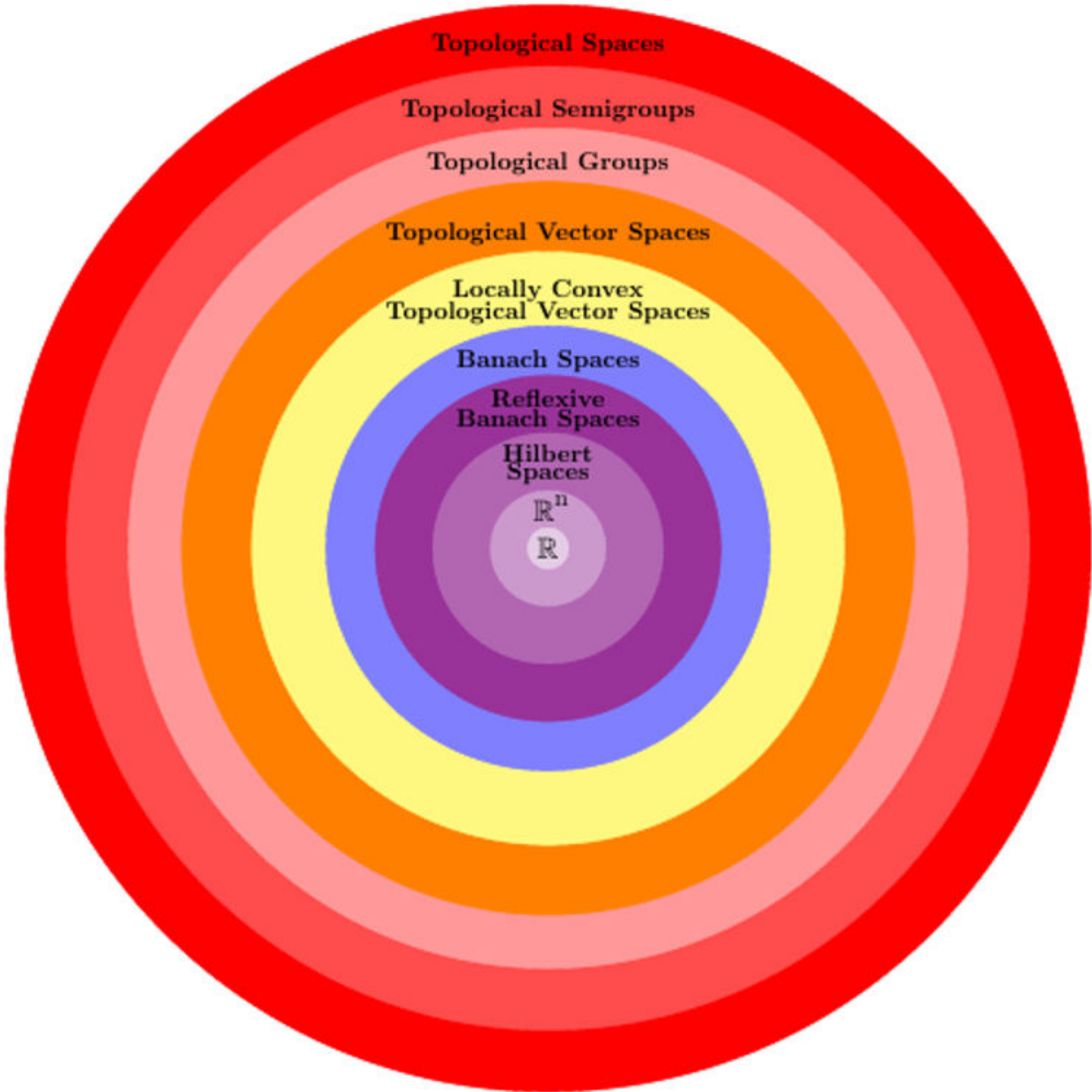

A5.0 Introduction

In this Appendix we give an introduction to the theory of topological groups, the Pontryagin-van Kampen duality and structure theory of locally compact abelian groups¹¹. It assumes that the reader is familiar with the notion of **group** as is included in an introductory course on group theory or usually in an introductory course on abstract algebra¹².

We shall begin by **Meandering Through a Century of Topological Groups**.

This sets the stage for the study of topological groups, however the impatient reader can move onto [§A5.1](#).

¹¹Most of the material in this Appendix is taken from Morris [293].

¹²A beautiful book on group theory is available as a free download. It is Macdonald [268].

In 1872 (**Christian**) **Felix Klein**, aged 23, was appointed to a full Professorship at Erlangen in Germany. In his first year as Professor he published the ‘Erlangen Program’¹³.

In his 1925 obituary of Klein, Richard Courant¹⁴ wrote, this is “perhaps the most influential and widely read paper in the second half of the nineteenth century”.

In 1940 Julian Lowell Coolidge¹⁵ wrote that it “probably influenced geometrical thinking more than any other work since the time of Euclid, with the exception of Gauss and Riemann”.

Klein was influenced by Julius Plücker (1801–1868) and Rudolf Friedrich Alfred Clebsch (1833–1872), both of whom had made significant contributions to geometry.

Klein completed his PhD in 1868 at the age of 19, shortly after his (first) PhD adviser, Julius Plücker¹⁶, died.

After Plücker’s death, Klein came under the influence of Rudolf Clebsch¹⁷, who assisted Klein obtain the Professorship at Erlangen. [Clebsch died in 1872 before the publication of the Erlangen Program.] When Clebsch died, most of his PhD students moved to Erlangen and became students¹⁸ of Klein.



Klein



Plücker



Clebsch

¹³‘Erlanger Programm’ in German,

¹⁴“Felix Klein”, Jahresbericht der Deutschen Math. Vereinigung 34 (1925), 197–213.

¹⁵“A History of Geometrical Methods”, Oxford: Clarendon Press, 1940.

¹⁶Plücker was a mathematical descendant of Carl Friedrich Gauss. Klein was also a mathematical descendant of Leonhard Euler via his second PhD adviser Rudolf Otto Sigismund Lipschitz

¹⁷Clebsch and Carl Neumann founded ‘Mathematische Annalen’ and Klein made it one of the best mathematics journals.

¹⁸Klein had a total of 57 PhD students and now has over 30,000 mathematical descendants [including Karl Hofmann with whom I have coauthored books on compact groups and pro-Lie groups].

The Mathematical Genealogy Project

www.genealogy.math.ndsu.nodak.edu

has the following information, where we see for example that Klein supervised the PhD research of Lindemann who in turn supervised the PhD research of Hilbert.

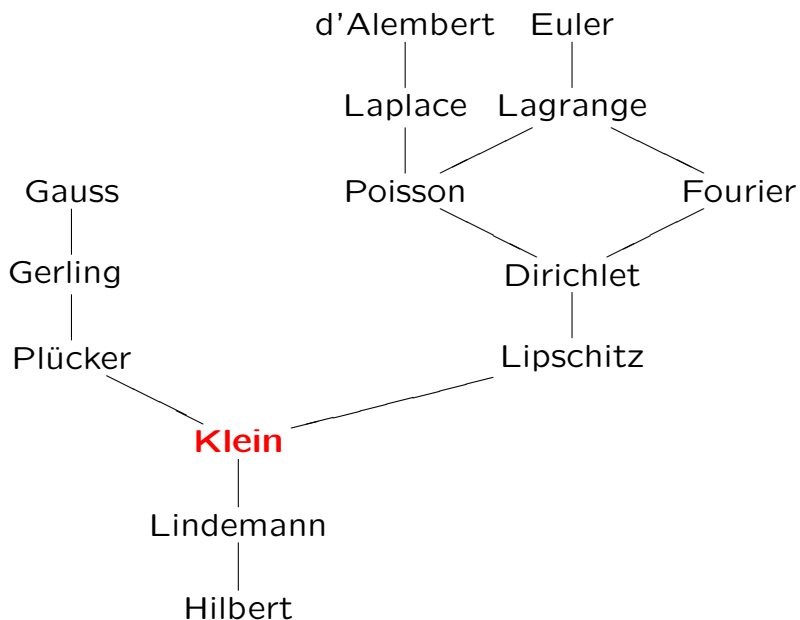

Amongst these students who transferred to Klein was **Ferdinand Lindemann**, who in 1882 proved that π is a [transcendental number](#); that is, π is not a root of any polynomial with rational number coefficients.

It was known that if π were transcendental, then the 2,000 year old problem of *squaring the circle* by compass and straightedge would be solved in the negative.

Three ancient problems,

- (i) **Delian problem – doubling the cube**, i.e. constructing a cube of volume double that of a given cube,
- (ii) **trisecting any given angle**,
- (iii) **squaring the circle (or quadrature of the circle)**, that is constructing a square whose area equals that of a given circle,

in each case using only a straight edge and compass, fascinated professional & amateur mathematicians alike. (See Jones et al. [221].)

In 1775 the Paris Academy found it necessary to pass a resolution that *no more solutions of any of these problems or of machines exhibiting perpetual motion were to be examined.*

Why did it take so long for these problems to be solved?

It was because an understanding came not from geometry but from abstract algebra (actually field theory) a subject not born until the 19th century. The first two problems were solved by Pierre Laurent Wantzel (1814–1848) in 1837 and the third by Carl Louis Ferdinand von Lindemann.



Wantzel



Lindemann

The field theory used in solving these ancient problems was also used by Robert Henry Risch in the Risch Algorithm, https://en.wikipedia.org/wiki/Risch_algorithm, in 1968 which transforms the problem of indefinite integration into a problem in algebra. The algorithm is partly implemented in the popular computer algebra package Maple¹⁹.

So we see abstract algebra played a vital role in solving geometry problems dating back 2,000 years and played a key role in the progress of computer algebra.

Now we set the stage for the Erlangen Program of Felix Klein.

We have all met Euclidean geometry which has points, lines, angles, and a metric (distance) and of course the famous Pythagoras theorem for right angled triangles which says that the square of the length of the hypotenuse equals the sum of the squares of the lengths of the other two sides.

In Euclidean geometry every two points determine a line. However two lines do not necessarily determine a point: if they are not parallel, they do determine a point (of intersection) but if they are parallel, they don't determine a point. This is a little disappointing.

¹⁹See www.maplesoft.com.

But a greater disappointment comes from art (or rather perspective): if we have a two dimensional picture/sketch/representation of a 3-dimensional object, then distances, angles, & parallel lines are not preserved. This can be easily seen in the two pictures on the next page. (See [Credit for Images.](#))

In 1413 the Renaissance architect Filippo Brunelleschi introduced the geometrical method of perspective. In 1435, italian author, artist, architect, poet, priest, linguist, philosopher and cryptographer Leon Battista Alberti wrote *Della pittura*, a treatise on how to represent distance in painting. He used classical optics to explain perspective in art.



Brunelleschi



Alberti



“School of Athens” by Renaissance artist, Raphael
(Raffaello *Sanzio* da Urbino, 1483 – 1520)



The branch of geometry dealing with the properties of geometric figures that remain invariant under projection is called **projective geometry**, and in earlier literature – descriptive geometry.

A5.0.1 Definitions. Let V be a vector space. The **projective space**, $P(V)$, is the set of one-dimensional vector subspaces of V .

If the vector space V has dimension $n + 1$, then $P(V)$ is said to be a **projective space of dimension n** .

A one-dimensional projective space is called a **projective line**, and a two-dimensional projective space is called a **projective plane**.

(See [Examples 11.3.4](#) for a further discussion of the real projective plane and real projective space.)

If V is the 3-dimensional vector space over the field \mathbb{R} of real numbers, the projective space $P^2(\mathbb{R})$ has as its **“points”** the 1-dimensional vector subspaces and its **“lines”** are the 2-dimensional vector subspaces.

A “point” S is said to **lie on a “line” L** if the space S is contained in the space L . Note that

- (i) any two distinct “points” determine a unique “line”;
 - (ii) any two distinct “lines” determine a unique “point”.
- There are no parallel “lines”.
 - There is a duality between “points” & “lines”; theorems remain true with “point” and “line” interchanged.

Using so-called **homogeneous co-ordinates**, we can represent points in the projective plane as the set of all triples (u, v, w) , except $(0, 0, 0)$, where $u, v, w \in \mathbb{R}$, and for any $c \in \mathbb{R} \setminus \{0\}$, the points (u, v, w) and (cu, cv, cw) are identified.

Of these points (u, v, w) , those with $w \neq 0$ can be regarded as points $\left(\frac{u}{w}, \frac{v}{w}\right)$ in the Euclidean plane, whereas the points $(u, v, 0)$, can be thought of as points at infinity.

So the projective plane can be thought of as consisting of the euclidean plane plus points at infinity.

Formally this says, $P^2(\mathbb{R}) = \mathbb{R}^2 \cup P^1(\mathbb{R})$.

We are now in a position to say a few words about the Erlangen Program²⁰ of Felix Klein.

In 1869, Klein went to Berlin and in his own words "The most important event of my stay in Berlin was certainly that, toward the end of October, at a meeting of the Berlin Mathematical Society, I made the acquaintance of the Norwegian, Sophus Lie. Our work had led us from different points of view finally to the same questions, or at least to kindred ones. Thus it came about that we met every day and kept up an animated exchange of ideas."

"The E.P. itself.. was composed in October, 1872... Lie visited me for two months beginning September 1. Lie, who on October 1 accompanied me to Erlangen... had daily discussions with me ... entered eagerly into my idea of classifying the different approaches to geometry on a group-theoretic basis."²¹

Vergleichende Betrachtungen

über

neuere geometrische Forschungen

von

Dr. Felix Klein,

o. ö. Professor der Mathematik an der Universität Erlangen.

Programm

zum Eintritt in die philosophische Facultät und den Senat
der k. Friedrich-Alexanders-Universität
zu Erlangen.

Erlangen.

Verlag von Andreas Deichert.
1872.

Erlangen Programm

²⁰See <http://tinyurl.com/jxbctma> for the original Erlangen Program and <http://tinyurl.com/hb8pmtn> for an English translation, and Klein [240]

²¹See Garrett Birkhoff and M. K. Bennett, Felix Klein and his "Erlanger Programm", in History and Philosophy of Modern Mathematics, eds. W. Aspray and P. Kitcher, Minnesota Stud. Philos. Sci. XI, University of Minnesota Press, Minneapolis (1988), 145-176. <http://tinyurl.com/8mjstzd>

Klein suggested that not only euclidean geometry, but also the “new” non-Euclidean geometries, can be regarded as “sub-geometries” of projective geometry²²

He also suggested each geometry can be characterized by the invariants of its associated transformation group.

In euclidean geometry, figures F_1 & F_2 are “equal” if they are congruent; i.e., F_2 is obtained from F_1 by a rigid motion (translation, rotation, & reflection) of euclidean space. So the transformation group associated with euclidean geometry is the group consisting of the transformations corresponding to rigid motions.

Each geometry is similarly characterized by its symmetries using the group of geometric transformations of a space each of which take any figure onto an “equal” figure in that geometry.

The set of geometric transformations should have certain natural properties, such as

- (1) every figure F is ‘equal’ to itself;
- (2) if a figure F_1 is ‘equal’ to F_2 , then F_2 is ‘equal’ to F_1 ; and
- (3) if F_1 is ‘equal’ to F_2 and F_2 is ‘equal’ to F_3 , then F_1 is ‘equal’ to F_3 .

So we are led to insist that the set of transformations is in fact a group.

²²Klein proposed to mathematical physicists that even a moderate cultivation of the projective purview might bring substantial benefits. A major success was when Klein’s colleague, Hermann Minkowski (1864–1909), showed that the essence of Einstein’s Special Theory of Relativity is captured by the (spacetime) geometry of the Lorentz group. (See https://en.wikipedia.org/wiki/Lorentz_group for a discussion of the Lorentz group.)

Nobel Laureate Eugene Paul Wigner (1902–1995) advocated extending the Erlangen Program to physics and demonstrated that **symmetries expose the deepest secrets of physics**. Quark theory, (See <https://en.wikipedia.org/wiki/Quark> for a description of quarks.) and even the Higgs boson particle (See https://en.wikipedia.org/wiki/Higgs_boson.) theory, are consequences of this approach. See Amir D. Aczel, “It’s a Boson! The Higgs as the Latest Offspring of Math & Physics”, <http://tinyurl.com/bqaonns>.

A5.0.2 Definitions. A set, G , together with an operation \cdot , such that for all $a, b \in G$, $a \cdot b \in G$, is said to be a **group** if

- (i) $(a \cdot b) \cdot c = a \cdot (b \cdot c)$, $\forall a, b, c \in G$; [associativity]
- (ii) there exists an element 1 in G , such that $1 \cdot a = a \cdot 1 = a$, for every element $a \in G$; The (unique) element $1 \in G$ with this property is said to be the **identity** of the group.
- (iii) for each a in G , there exists an element b in G such that $a \cdot b = b \cdot a = 1$. The (unique) element b is called the **inverse** of a in G and is written a^{-1} .

A group G is said to be an **abelian group** if $a \cdot b = b \cdot a$, for all $a, b \in G$.

A5.0.3 Examples. We list some important examples:

- (i) the group, \mathbb{R} , of all real numbers with the operation of addition; [Note that the set of real numbers with the operation of multiplication is not a group as the element 0 has no inverse.]
- (ii) the group, \mathbb{Q} , of all rational numbers with the operation of addition; We call \mathbb{Q} a **subgroup** of \mathbb{R} as $\mathbb{Q} \subset \mathbb{R}$ and the group operation on \mathbb{Q} is the restriction of the group operation on \mathbb{R} . A subgroup N of a group G is called a **normal subgroup** if for all $n \in N$ and $g \in G$, $gng^{-1} \in N$.
- (iii) the subgroup, \mathbb{Z} , of \mathbb{R} consisting of all integers;
- (iv) the group, \mathbb{T} , consisting of all complex numbers of modulus 1 (i.e. the set of numbers $e^{2\pi ix}$, $0 \leq x < 1$) with the group operation being multiplication of complex numbers. Then \mathbb{T} is called the **circle group**.

All of the above groups are abelian groups. □

For a plethora of examples of nonabelian groups, we turn to groups of matrices.

Recall that an $n \times n$ matrix M is said to be **nonsingular** (or **invertible**) if there is an $n \times n$ matrix M^{-1} such that $MM^{-1} = M^{-1}M = I$, where I is the $n \times n$ **identity matrix** (with 1s on the diagonal and 0 elsewhere).

A5.0.4 Definition. The multiplicative group of all nonsingular $n \times n$ matrices with complex number entries is called the **general linear group over \mathbb{C}** and is denoted by **$GL(n, \mathbb{C})$** . $GL(n, \mathbb{C})$ and its subgroups are called **matrix groups**.

As matrix multiplication is not commutative (i.e., $M_1.M_2$ does not necessarily equal $M_2.M_1$), each $GL(n, \mathbb{C})$ is a nonabelian group.

A5.0.5 Definition. The subgroup of $GL(n, \mathbb{C})$ consisting of all matrices M such that $M.M^t = M^t.M = I$ (i.e., $M^{-1} = M^t$), where t denotes transpose, is called the **orthogonal group** and is denoted by **$O(n, \mathbb{C})$** .

A5.0.6 Definition. If G and H are groups, then $G \times H$ is a group with the group operation being coordinatewise multiplication; i.e., if $g_1, g_2 \in G$ and $h_1, h_2 \in H$, then $(g_1, h_1) \cdot (g_2, h_2) = (g_1 \cdot g_2, h_1 \cdot h_2)$, where \cdot denotes the group operation on G , H and $G \times H$. The set $G \times H$ with this operation is called the **product group**.

If I is any index set, the infinite product of groups $G_i : i \in I$, $\prod_{i \in I} G_i$, is defined analogously.

A5.0.7 Definitions. Let G and H be groups and $f : G \rightarrow H$ a map

- (i) f is called a **homomorphism** if $f(g_1 \cdot g_2) = f(g_1) \cdot f(g_2)$, for all $g_1, g_2 \in G$.
- (ii) If f is also surjective (i.e., $f(G) = H$), then H is said to be a **quotient group** of G , written $H = G/N$, where the **kernel** $N = \{g \in G : f(g) = 1\}$.
- (iii) If f is bijective (i.e. injective [$f(x) = f(y) \Rightarrow x = y$] and surjective), then f is called an **isomorphism**.

Let G be a group with identity element 1 , N a normal subgroup of G and H a subgroup of G . The following statements are equivalent:

- (i) $G = NH$ and $N \cap H = \{1\}$.
- (ii) Every element of G can be written uniquely as a product of an element of N and an element of H .

If one (= both) of these is true, then G is called a **semidirect product of N and H** , written $G = N \rtimes H$.

Semidirect product is more general than product; if H is also a normal subgroup, then $N \rtimes H = N \times H$.

Pertinent to our earlier discussion are

- (i) the **projective group**, $\mathbf{PGL}(n, \mathbb{R})$ which is defined as the quotient group $\mathrm{GL}(n, \mathbb{R})/K$, where the kernel, K , is $\{\lambda I_n : \lambda \in \mathbb{R}\}$ and I_n denotes the $n \times n$ identity matrix; and
- (ii) the **euclidean group**, $\mathbf{E}(2)$, of all rigid motions of the plane, \mathbb{R}^2 , is a semidirect product of the abelian group \mathbb{R}^2 (which describes translations) and the orthogonal group $\mathrm{O}(2, \mathbb{R})$ (which describes rotations and reflections which fix the origin $(0,0)$).

Felix Klein focussed on “discontinuous” groups and Sophus Lie focussed on “continuous” groups.

A5.0.8 Definition. Let G be a group with a topology \mathcal{T} . Then G is said to be a **topological group** if the maps $G \rightarrow G$ given by $g \mapsto g^{-1}$ and $G \times G \rightarrow G$ given by $(g_1, g_2) \mapsto g_1 \cdot g_2$ are continuous.

A5.0.9 Examples. (i) Let G be any group with the discrete topology. Then G is a topological group. In particular, if G is any finite group with the discrete topology then G is a compact topological group.

(ii) $\mathbb{R}, \mathbb{T}, \mathbb{Z}, \mathbb{Q}, \mathbb{R}^a \times \mathbb{T}^b \times \mathbb{Z}^c$, for any non-negative integers a, b and c with the usual topologies and the usual group operations are topological groups.

(iii) For each $n \in \mathbb{N}$, the group $\text{GL}(n, \mathbb{C})$ and all of its subgroups can be regarded as subsets of \mathbb{C}^{n^2} and so have subspace topologies and with these topologies they are topological groups.

(iv) With the above topology, each $\text{O}(n, \mathbb{C})$ is a compact group, which is **Hausdorff**²³.

A5.0.10 Definition. Topological groups G and H are said to be **topologically isomorphic** if there exists a mapping $f : G \rightarrow H$ such that f is a homeomorphism and an isomorphism. This is written $G \cong H$.

A5.0.11 Definition. A topological group is said to be a **compact Lie group** if it is topologically isomorphic to a closed subgroup of an orthogonal group, $\text{O}(n)$, for some $n \in \mathbb{N}$.

More generally, a **Lie group** is a group which is also a differentiable manifold, with the property that the group operations are compatible with the smooth structure. [See <http://tinyurl.com/jeo75r7> for a description of differentiable manifolds.]



(Marius) Sophus Lie

²³All topological groups from here on **in this introductory section** are assumed to be Hausdorff.

The Lorentz group, already mentioned in the context of Einstein's Special Relativity, and the Heisenberg group²⁴ which plays a key role in Quantum Mechanics²⁵ are Lie groups²⁶

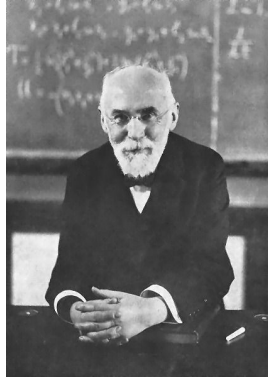
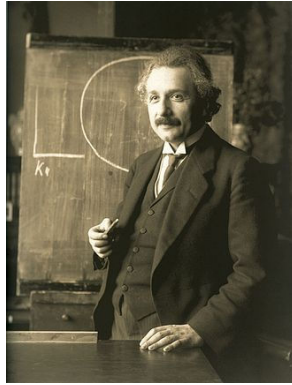
Lorentz²⁷Einstein²⁸Heisenberg²⁹

Recall that a topological group G is called **locally euclidean** if it has an open set containing 1 which is homeomorphic to an open set containing 0 in \mathbb{R}^n , $n \in \mathbb{N}$.

Note that for topological groups

- (i) compact \Rightarrow locally compact;
- (ii) locally euclidean \Rightarrow locally compact;
- (iii) \mathbb{R}^n , $n \in \mathbb{N}$, are not compact;
- (iv) $\mathbb{R}^a \times \mathbb{T}^b \times \mathbb{Z}^c$, a, b, c nonnegative integers, and all Lie groups are locally euclidean.

In 1976 Jean Alexandre Eugène Dieudonné³⁰ (1906–1992) quipped “Les groupes de Lie sont devenus le centre de mathématique. On ne peut rien faire de sérieux sans eux.” (Lie groups have moved to the centre of mathematics. One cannot seriously undertake anything without them.) Here “Lie theory” meant the structure theory of Lie algebras and Lie groups, and in particular how the latter is based on the former.



Dieudonné

²⁴See https://en.wikipedia.org/wiki/Heisenberg_group for a description of the Heisenberg group

²⁵See <http://citeseerx.ist.psu.edu/viewdoc/download?doi=10.1.1.419.4136&rep=rep1&type=pdf> for a discussion of the Heisenberg group and Quantum Mechanics.

²⁶For a fascinating article on the Higgs Boson, and unifying General Relativity & Quantum Mechanics and their relation to the Exceptional Simple Lie Group E_8 , see A.G. Lisi and J.O. Weatherall, “A Geometric Theory of Everything”, Scientific American 303(2010) 54–61.

²⁷Hendrik Antoon Lorentz (1853–1928)

²⁸Albert Einstein (1879–1955)

²⁹Werner Heisenberg (1901–1976)

³⁰Dieudonné was a member of the Bourbaki group. See <http://tinyurl.com/nl9k58s>.

At the International Congress of Mathematicians in 1900, David Hilbert (1862–1943) presented 23 problems that set the course for much of the mathematical creativity of the 20th century.

Hilbert's fifth problem asked whether (in later terminology) a locally euclidean topological group is in fact a Lie group. **It required half a century of effort on the part of several generations of eminent mathematicians until it was settled in the affirmative.**

The most influential book on the solution of Hilbert's fifth problem and the structure of locally compact groups was Montgomery and Zippin [288].

A recent presentation of this work, and winner of the 2015 Prose Award for Best Mathematics Book, is by the UCLA³¹ academic, Australian born Flinders University³² graduate and 2006 Fields Medalist, Terence Chi-Shen Tao [389]³³.

Tao points out striking applications: Gromov's celebrated theorem on groups of polynomial growth, and to the classification of finite approximate groups and to the geometry of manifolds.



Hilbert



Tao

³¹<http://www.ucla.edu/>

³²<http://www.flinders.edu.au/>

³³Terry Tao is a mathematical descendant of Leonhard Euler

For 5 years Per Enflo looked at extending Hilbert's Fifth Problem to nonlocally compact groups and he said this "turned out to be useful for solving famous problems in Functional Analysis" – he solved "the approximation problem" and the "basis problem" in Enflo [129] and the "invariant space problem" in Enflo [128].

For problem 153 in the Scottish Problem Book, https://en.wikipedia.org/wiki/Scottish_Book, which was later recognized as being closely related to Stefan Banach's "basis problem", Stanisław Mazur offered the prize of a live goose. This problem was solved only in 1972 by Per Enflo, who was presented with the live goose in a ceremony that was broadcast throughout Poland.

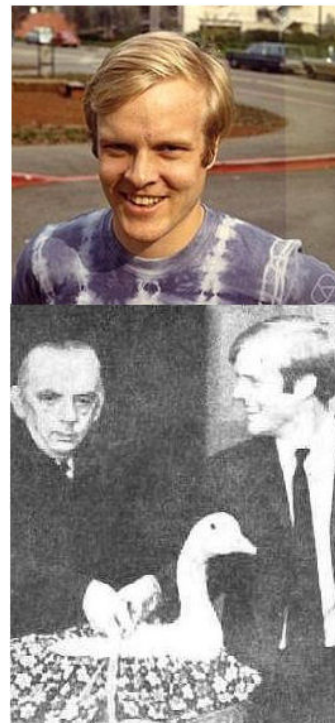

Per Enflo and
Mazur, goose, and Enflo

At the beginning of the translation of the Scottish Problem Book, <http://tinyurl.com/jmrmuuh>, Stanisław Marcin Ulam writes: “The enclosed collection of mathematical problems has its origin in a notebook which was started in Lwów, in Poland in 1935. If I remember correctly, it was S. Banach who suggested keeping track of some of the problems occupying the group of mathematicians there. The mathematical life was very intense in Lwów. Some of us met practically every day, informally in small groups, at all times of the day to discuss problems of common interest, communicating to each other the latest work and results. Apart from the more official meetings of the local sections of the Mathematical Society (which took place Saturday evenings, almost every week!), there were frequent informal discussions mostly held in one of the coffee houses located near the University building - one of them a coffee house named “Roma”, and the other “The Scottish Coffee House”. This explains the name of the collection. A large notebook was purchased by Banach and deposited with the headwaiter of the Scottish Coffee House, who, upon demand, would bring it out of some secure hiding place, leave it at the table, and after the guests departed, return it to its secret location.

Many of the problems date from years before 1935, They were discussed a great deal among the persons whose names are included in the text, and then gradually inscribed into the book in ink.” ...

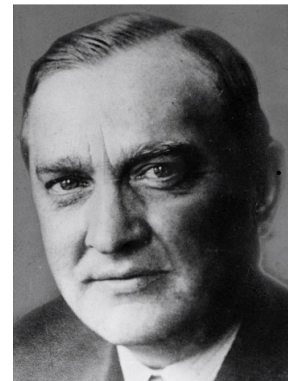

Banach



Mazur



Ulam

“As most readers will realize, the city of Lwów, and with it the Scottish Book, was fated to have a very stormy history within a few years of the book’s inception. A few weeks after the outbreak of World War II, the city was occupied by the Russians. From items at the end of this collection, it will be seen that some Russian mathematicians must have visited the town; they left several problems (and prizes for their solutions). The last date figuring in the book is May 31, 1941. Item Number 193 contains a rather cryptic set of numerical results, signed by (Władysław Hugo Dionizy) Steinhaus, dealing with the distribution of the number of matches in a box! After the start of war between Germany and Russia, the city was occupied by German troops that same summer and the inscriptions ceased.”



Steinhaus



Weyl

Partial solutions to Hilbert’s Fifth Problem came as the structure of topological groups was understood better: in 1923 Hermann Weyl (1885–1955) and his student Fritz Peter laid the foundations of the representation and structure theory of compact groups, and a positive answer to Hilbert’s Fifth Problem **for compact groups** was a consequence, drawn by John von Neumann (1903–1957) in 1932.



von Neumann

A5.0.12 Theorem. [Peter-Weyl Theorem] Let G be any compact group. Then G is topologically isomorphic to a (closed) subgroup of a product of orthogonal groups.

Lev Semyonovich Pontryagin (1908–1988) and Egbert Rudolf van Kampen (1908–1942) developed in 1932, resp., 1936, the duality theory of locally compact abelian groups laying the foundations for abstract harmonic analysis which flourished throughout the second half of the 20th century.

Pontryagin-van Kampen Duality³⁴ provided the central method for attacking the structure theory of locally compact abelian groups. A positive response to Hilbert's question for locally euclidean abelian groups followed in the wash.



Pontryagin



van Kampen

A5.0.13 Definition. If A is any abelian group, then the group $\text{Hom}(A, \mathbb{T})$ of all group homomorphisms of A into the circle group \mathbb{T} (no continuity involved!) given the subspace topology from the product space \mathbb{T}^A (of all maps of A into \mathbb{T}) is called the **dual group** of A and is written \hat{A} .

As the dual group is clearly a closed subset of \mathbb{T}^A , we obtain:

A5.0.14 Proposition. The dual group of any abelian group is an abelian compact group.

A5.0.15 Definition. If G is any abelian compact group, then the abelian group (without topology) $\text{Hom}(G, \mathbb{T})$ of all continuous homomorphisms of G into \mathbb{T} is called the **dual group** of the abelian compact group G and is written \hat{G} .

So if G is an abelian compact group, then its dual group, \hat{G} , is an abelian group and the dual group of that dual group, $\hat{\hat{G}}$, is again an abelian compact group.

³⁴See Morris [293].

Further there is a natural evaluation map from G into its second dual, namely $\eta : G \rightarrow \widehat{\widehat{G}}$, where for each $g \in G$, $\eta(g) = \eta_g : \widehat{G} \rightarrow \mathbb{T}$ and for each $\gamma \in \widehat{G}$, $\eta_g(\gamma) = \gamma(g) \in \mathbb{T}$.

A5.0.16 Theorem. [Pontryagin-van Kampen Duality for Compact Groups]

If G is any abelian compact group, then the evaluation map $\eta : G \rightarrow \widehat{\widehat{G}}$ is a topological group isomorphism.

A5.0.17 Remark. The above theorem implies that no information about G is lost in going to the dual group. But the dual group is just an abelian group without topology. From this we deduce the fact that **every piece of information about G can be expressed in terms of algebraic information about its dual group.** So questions about compact abelian groups are reduced to ones about abelian groups.

The next proposition provides some examples of this:

A5.0.18 Proposition. Let G be an abelian compact group.

- (i) The weight, $w(G)$, of G equals the cardinality of its dual group \widehat{G} ;
- (ii) G is metrizable if and only if its dual group \widehat{G} is countable;
- (iii) G is connected if and only if its dual group \widehat{G} is torsion-free (i.e., it has no nontrivial finite subgroups);
- (iv) G is torsion-free if and only if its dual group \widehat{G} is divisible (i.e., if $g \in \widehat{G}$, then there is an $h_n \in \widehat{G}$ with $(h_n)^n = g$, for all positive integers n .)

The next theorem is quite surprising.

A5.0.19 Theorem. If abelian connected compact groups G_1 and G_2 are homeomorphic, then they are topologically isomorphic.

A topological group G is said to be a **protorus** if it is compact connected and abelian. So **Theorem A5.0.19** can be restated: **Two protori are topologically isomorphic if and only if they are homeomorphic.**

We now present the main structure theorem for locally compact abelian groups which follows from Pontryagin van-Kampen Duality and answers Hilbert's fifth problem for locally compact abelian groups.

A5.0.20 Theorem. Every connected locally compact abelian group is topologically isomorphic to $\mathbb{R}^n \times K$, where K is a compact connected abelian group and n is a nonnegative integer.

One of the most significant papers on topological groups was published in 1949 by Kenkichi Iwasawa (1917–1998), 3 years before Hilbert's Fifth Problem was finally settled by the concerted contributions of Andrew Mattei Gleason (1921–2008), Dean Montgomery (1909–1992), Leon Zippin (1905–1995), and Hidehiko Yamabe (1923–1960).

It was Iwasawa who recognized for the first time that the structure theory of locally compact groups reduces to that of compact groups and Lie groups provided one knew that they happen to be approximated by Lie groups in the sense of projective limits, in other words, if they were pro-Lie groups. [See Hofmann and Morris [190].]

And this is what Yamabe established in 1953 for all locally compact groups G which are almost connected (i.e., the quotient group of G by its connected identity component is compact), e.g. connected locally compact groups or compact groups.

In 1976 the Council of the Australian Mathematical Society resolved to bring a high calibre speaker from overseas for each Annual Meeting. The first of these invited speakers, in 1977, was Karl Heinrich Hofmann³⁵.



Iwasawa



Montgomery



Zippin



Gleason



Yamabe

³⁵Hofmann is a mathematical grandson of David Hilbert.

Hofmann was aware that in 1957 Richard Kenneth Lashof (1922–2010) recognized that not only Lie groups, but any locally compact group G has a Lie algebra \mathfrak{g} . Hofmann believed that this observation was the nucleus of a complete and rich, although infinite dimensional, Lie theory which had never been exploited.

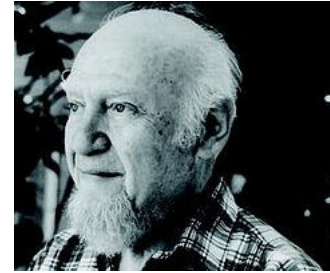

Lashof

In his 1977 AustMS invited lecture at La Trobe University, Hofmann made a bold proposal, and that was to extend Lie Theory from Lie groups to a much wider class of topological groups.

The first stage of this project was to extend the Lie Theory to all Compact Groups and this culminated in the publication of the first edition of the 800 page book, Karl H. Hofmann and Sidney A. Morris, “The Structure

of Compact Groups”, de Gruyter, 1998, with the 2nd edition in 2006, and the 3rd 900+ page edition, Hofmann and Morris [191], appearing in 2013. This book uses Lie Theory to expose the structure of compact groups, thereby proving old and new results by new methods.

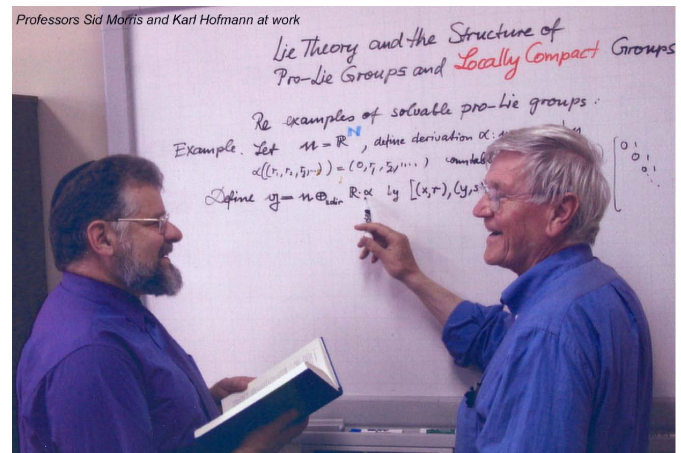

Karl Hofmann & Sidney Morris at work

In our book, Lie Theory is used to describe general compact groups in terms of their building blocks:

(i) simple simply connected Lie groups (which are known. For a discussion, see <http://tinyurl.com/hpqkjq2> in Wikipedia. The classification of simple Lie groups was done by Wilhelm Killing and Élie Cartan.)



Killing



Cartan

(ii) compact connected abelian groups (which are understood from Pontryagin-van Kampen Duality), and

(iii) profinite (\Leftrightarrow compact totally disconnected) groups.

For each topological group G define the topological space $\mathfrak{L}(G) = \text{Hom}(\mathbb{R}, G)$ of all continuous group homomorphisms from \mathbb{R} to G , endowed with the topology of uniform convergence on compact sets.

Define the continuous function $\exp : \mathfrak{L}(G) \rightarrow G$ by $\exp X = X(1)$ and a “scalar multiplication” $(r, X) \mapsto r.X : \mathbb{R} \times \mathfrak{L}(G) \rightarrow \mathfrak{L}(G)$ by $(r.X)(s) = X(sr)$.

This is useful when G is such that $\mathfrak{L}(G)$ is a Lie algebra with addition and bracket multiplication continuous. In Hofmann and Morris [191], it is shown that this occurs for all compact groups.

Having demonstrated conclusively the power of Lie Theory in the context of compact groups, the second stage was to apply it to locally compact groups. However, the category of locally compact groups is not a good one, as even infinite products of locally compact groups are not locally compact except in the trivial case that they are almost all compact, e.g, even \mathbb{R}^{\aleph_0} is not locally compact. The category of all pro-Lie groups (and their continuous homomorphisms) is well-behaved and includes all compact groups, all Lie groups, and all connected locally compact groups.



Hofmann and Morris, August 2016

Pro-Lie groups are defined to be projective limits of Lie groups. Lie Theory was successfully applied to this class and the structure of these groups was fully exposed in the 600+ page book: Karl H. Hofmann and Sidney A. Morris, “The Lie Theory of Connected Pro-Lie Groups”, European Mathematical Society Publ. House, 2007, Hofmann and Morris [190].

Our next beautiful structure theorem describes the the structure of abelian connected pro-Lie groups completely and the topology of connected pro-Lie groups.

A5.0.21 Theorem. Let G be a connected pro-Lie group. Then G is homeomorphic to $\mathbb{R}^J \times C$, for some set J and maximal (connected) compact subgroup, C , of G . If G is abelian, then G is topologically isomorphic to $\mathbb{R}^J \times C$.

The above theorem due to Karl H. Hofmann and Sidney A. Morris is a generalization of the classical result for connected locally compact groups.

A5.0.22 Theorem. Let G be a connected locally compact group. Then G is homeomorphic to $\mathbb{R}^n \times C$, for some set $n \in \mathbb{N}$ and maximal (connected) compact subgroup, C , of G . If G is abelian, then G is topologically isomorphic to $\mathbb{R}^n \times C$.

We aim to describe the topology of compact groups in terms of simple simply connected compact Lie groups, compact connected abelian groups, and profinite groups.

Our next result is surprising. This theorem tells us **everything** about the **topology** of totally disconnected compact groups.

A5.0.23 Theorem. The underlying topological space of every infinite totally disconnected compact group is a Cantor cube.

This result is not trivial, but it can be proved by elementary means or by an application of the structure theory of compact groups.

We shall see that the above theorem does much more than describe the topology of a special class of compact groups.

A5.0.24 Definition. If G is any topological group, then the largest connected set containing 1 is said to be the **identity component** of G and is denoted by G_0 .

It is readily verified that for any topological group G , the identity component G_0 is a closed normal subgroup of G .

Further, if G is a compact group, then G_0 is a compact group.

The following proposition is obvious.

A5.0.25 Proposition. Let G be a topological group. Then the quotient group G/G_0 is a totally disconnected topological group. Further, if G is a compact group, then G/G_0 is a totally disconnected compact group.

Now we state a powerful result which significantly reduces the task of describing the topology of a general compact group.

A5.0.26 Theorem. If G is any compact group then it is homeomorphic to the product group $G_0 \times G/G_0$.

Theorem A5.0.26 and Theorem A5.0.23 together reduce the study of the topology of compact groups to the study of the topology of connected compact groups.

A5.0.27 Definition. Let G be a topological group. Then G is said to have **no small subgroups** or be an **NSS-group** if there exists an open set O containing the identity and O contains no non-trivial subgroup of G .

For each positive integer n , the compact groups $O(n)$, each discrete group, \mathbb{T} , \mathbb{R} , and $\mathbb{R}^a \times \mathbb{T}^b \times \mathbb{Z}^c$, for non-negative integers a, b, c are NSS-groups.

A5.0.28 Theorem. [Hilbert 5 for Compact Groups] If G is a compact group, then the following conditions are equivalent:

- (i) G is a Lie group;
- (ii) G is an NSS-group;
- (iii) the topological space $|G|$ is **locally euclidean** (that is, an open set containing 1 in G is homeomorphic to an open set containing 0 in \mathbb{R}^n , for some positive integer n).

Condition (iii) proves that compact Lie groups are characterized by just their topology. This is a beautiful result.

The work of D. Montgomery, L. Zippin and A. Gleason in the 1950s characterized noncompact Lie groups by conditions (ii) and (iii) above.

Earlier we reduced the study of the topology of compact groups to the study of the topology of connected compact groups.

Next we reduce the study to that of the topology of

(a) **abelian** connected compact groups

and what we shall call

(b) **semisimple** groups.

A5.0.29 Definition. Let g, h be elements of a group G . Then $g^{-1}h^{-1}gh \in G$ is said to be a **commutator** and the smallest subgroup of G containing all commutators is called the **commutator subgroup** and denoted by G' .

A5.0.30 Theorem. If G is any connected compact group, then G' is connected and

- (i) every element of G' is a commutator,
- (ii) G' is a compact group, and
- (iii) $G'' = G'$.

Condition (i) is remarkable; (ii) and (iii) are not valid without connectivity.

A5.0.31 Definition. A connected compact group G is said to be **semisimple** if $G' = G$.

A5.0.32 Corollary. If G is any connected compact group, then G' is semisimple.

A5.0.33 Theorem. If G is a connected compact group, it is homeomorphic to $G' \times G/G'$.

A5.0.34 Corollary. If G is any compact group then it is homeomorphic to $G/G_0 \times (G_0)' \times G_0/(G_0)'$, where G/G_0 is homeomorphic to a Cantor cube.

We now state the Sandwich Theorem for Semisimple Connected Compact Groups. This tells us that each semisimple connected compact group is almost a product of simple simply connected Lie groups.

A5.0.35 Theorem. Let G be a semisimple connected compact group. Then there is a family $\{S_j \mid j \in J\}$ of simple simply connected compact Lie groups and surjective continuous homomorphisms q and f

$$\prod_{j \in J} S_j \xrightarrow{f} G \xrightarrow{q} \prod_{j \in J} S_j/Z(S_j)$$

where each finite discrete abelian compact group $Z(S_j)$ is the centre of S_j and

$$\prod_{j \in J} S_j \xrightarrow{qf} \prod_{j \in J} S_j/Z(S_j)$$

is the product of the quotient morphisms $S_j \rightarrow S_j/Z(S_j)$.

A5.0.36 Remark. In conclusion, then, we have that every compact group is homeomorphic to the product of three groups whose topology we know: a compact totally disconnected group (which is homeomorphic to a Cantor cube), a compact connected abelian group, and a compact connected semisimple group.

Using Theorem A5.0.21 we then have that every connected pro-Lie group is also homeomorphic to a product of three groups whose topology we know: \mathbb{R}^I for some index set I , a compact connected abelian group, and a compact connected semisimple group.

This completes our meandering through a century of study of topological groups. Hopefully this overview of some of the highlights puts what follows in this appendix into context. The next section begins our formal study of topological groups.

A5.1 Topological Groups

A5.1.1 Definition. Let (G, \mathcal{T}) be a set G , that is a group, with a topology \mathcal{T} on G . Then (G, \mathcal{T}) is said to be a **topological group** if

- (i) the mapping $(x, y) \rightarrow xy$ of the product space $(G, \mathcal{T}) \times (G, \mathcal{T})$ onto (G, \mathcal{T}) is continuous, and
- (ii) the mapping $x \rightarrow x^{-1}$ of (G, \mathcal{T}) onto (G, \mathcal{T}) is continuous.

A5.1.2 Examples.

- (1) The additive group of real numbers with the euclidean topology is a topological group, usually denoted by \mathbb{R} .
- (2) The multiplicative group of positive real numbers with the induced topology from \mathbb{R} is also a topological group.
- (3) The additive group of rational numbers with the euclidean topology is a topological group denoted by \mathbb{Q} .
- (4) The additive group of integers with the discrete topology is a topological group denoted by \mathbb{Z} .
- (5) Any group with the discrete topology is a topological group.
- (6) Any group with the indiscrete topology is a topological group.
- (7) The "circle" group consisting of the complex numbers of modulus one (i.e. the set of numbers $e^{2\pi ix}$, $0 \leq x < 1$) with the group operation being multiplication of complex numbers and the topology induced from the euclidean topology on the complex plane is a topological group. This topological group is denoted by \mathbb{T} (or S^1).
- (8) **Linear groups.** Let $A = (a_{jk})$ be an $n \times n$ matrix, where the coefficients a_{jk} are complex numbers. The transpose ${}^t A$ of the matrix A is the matrix (a_{kj}) and the conjugate \bar{A} of A is the matrix (\bar{a}_{jk}) , where \bar{a}_{jk} is the complex conjugate of the number a_{jk} . The matrix A is said to be **orthogonal** if $A = \bar{A}$ and ${}^t A = A^{-1}$ and **unitary** if $A^{-1} = {}^t(\bar{A})$.

The set of all non-singular $n \times n$ matrices (with complex number coefficients) is called the **general linear group** (over the complex number field) and is denoted by $GL(n, \mathbb{C})$. The subgroup $GL(n, \mathbb{C})$ consisting of those matrices with determinant one is the **special linear group** (over the complex field) and is denoted by $SL(n, \mathbb{C})$. The **unitary group** $U(n)$ and the **orthogonal group** $O(n)$ consist of all unitary matrices and all orthogonal matrices, respectively; they are subgroups of $GL(n, \mathbb{C})$. Finally we define the **special unitary group** and the **special orthogonal group** as $SU(n) = SL(n, \mathbb{C}) \cap U(n)$ and $SO(n) = SL(n, \mathbb{C}) \cap O(n)$, respectively.

The group $GL(n, \mathbb{C})$ and all its subgroups can be regarded as subsets of \mathbb{C}^{n^2} , where \mathbb{C} denotes the complex number plane, and so \mathbb{C}^{n^2} is a $2n^2$ -dimension euclidean space. As such $GL(n, \mathbb{C})$ and all its subgroups have induced topologies and it is easily verified that, with these, they are topological groups.

A5.1.3 Remark. Of course not every topology on a group makes it into a topological group; i.e. the group structure and the topological structure need not be compatible. If a topology \mathcal{T} on a group G makes (G, \mathcal{T}) into a topological group, then \mathcal{T} is said to be a **group topology** or a **topological group topology**.

A5.1.4 Example. Let G be the additive group of integers. Define a topology \mathcal{T} on G as follows: a subset U of G is open if either

(a) $0 \notin U$, or

(b) $G \setminus U$ is finite.

Clearly this is a (compact Hausdorff) topology, but [Proposition A5.1.5](#) below shows that (G, \mathcal{T}) is not a topological group.

A5.1.5 Proposition. Let (G, \mathcal{T}) be a topological group. For each $a \in G$, left and right translation by a are homeomorphisms of (G, \mathcal{T}) . Inversion is also a homeomorphism.

Proof. The map $L_a : (G, \mathcal{T}) \rightarrow (G, \mathcal{T})$ given by $g \mapsto ag$ is the product of the two continuous maps

$(G, \mathcal{T}) \rightarrow (G, \mathcal{T}) \times (G, \mathcal{T})$ given by $g \mapsto (a, g)$, where $g \in G$, a is fixed, and

$(G, \mathcal{T}) \times (G, \mathcal{T}) \rightarrow (G, \mathcal{T})$ given by $(x, y) \mapsto xy$, $x, y \in G$,

and is therefore continuous. So left translation by any $a \in G$ is continuous. Further, L_a has a continuous inverse, namely $L_{a^{-1}}$, since $L_a [L_{a^{-1}}(g)] = L_a [a^{-1}g] = a(a^{-1}g) = g$ and $L_{a^{-1}} [L_a(g)] = L_{a^{-1}} [ag] = a^{-1}(ag) = g$. So left translation is a homeomorphism. Similarly right translation is a homeomorphism.

The map $I : (G, \mathcal{T}) \rightarrow (G, \mathcal{T})$ given by $g \mapsto g^{-1}$ is continuous, by definition. Also I has a continuous inverse, namely I itself, as $I[I(g)] = I[g^{-1}] = [g^{-1}]^{-1} = g$. So I is also a homeomorphism. \square

It is now clear that the (G, \mathcal{T}) in [Example A5.1.4](#) above is not a topological group as left translation by 1 takes the open set $\{-1\}$ onto $\{0\}$, but $\{0\}$ is not an open set. What we are really saying is that any topological group is a homogeneous space while the example is not. Homogeneous spaces are defined next.

A5.1.6 Definition. A topological space (X, \mathcal{T}) is said to be **homogeneous** if it has the property that for each ordered pair x, y of points of X , there exists a homeomorphism $f : (X, \mathcal{T}) \rightarrow (X, \mathcal{T})$ such that $f(x) = y$.

While every topological group is a homogeneous topological space, we will see shortly that not every homogeneous space can be made into a topological group.

A5.1.7 Definition. A topological space is said to be a **T_1 -space** if each point in the space is a closed set.

It is readily seen that any Hausdorff space is a T_1 -space but that the converse is false. See [Exercises 4.1 #13](#).

We will see, however, that any topological group which is a T_1 -space is Hausdorff. Incidentally, this is not true, in general, for homogeneous spaces—as any infinite set with the cofinite topology is a homogeneous T_1 space but is not Hausdorff. As a consequence we will then have that **not every homogeneous space can be made into a topological group**.

A5.1.8 Proposition. Let (G, \mathcal{T}) be any topological group and e its identity element. If U is any neighbourhood of e , then there exists an open neighbourhood V of e such that

- (i) $V = V^{-1}$ (that is, V is a **symmetric neighbourhood of the identity e**)
- (ii) $V^2 \subseteq U$.

(Here $V^{-1} = \{v^{-1} : v \in V\}$ and $V^2 = \{v_1 v_2 : v_1 \in V, v_2 \in V\}$, not the set $\{v^2 : v \in V\}$.)

Proof. Exercise. □

A5.1.9 Proposition. Any topological group (G, \mathcal{T}) which is a T_1 -space is also a Hausdorff space.

Proof. Let x and y be distinct points of G . Then $x^{-1}y \neq e$. The set $G \setminus \{x^{-1}y\}$ is an open neighbourhood of e and so, by [Proposition A5.1.8](#), there exists an open symmetric neighbourhood V of e such that $V^2 \subseteq G \setminus \{x^{-1}y\}$. Thus $x^{-1}y \notin V^2$.

Now xV and yV are open neighbourhoods of x and y , respectively. Suppose $xV \cap yV \neq \emptyset$. Then $xv_1 = yv_2$, where v_1 and v_2 are in V ; that is, $x^{-1}y = v_1v_2^{-1} \in V.V^{-1} = V^2$, which is a contradiction. Hence $xV \cap yV = \emptyset$ and so (G, \mathcal{T}) is Hausdorff. \square

A5.1.10 Remark. So to check that a topological group is Hausdorff it is only necessary to verify that each point is a closed set. Indeed, by [Proposition A5.1.5](#), it suffices to show that $\{e\}$ is a closed set.

Warning. Many authors include "Hausdorff" in their definition of topological group.

A5.1.11 Remark. The vast majority of work on topological groups deals only with Hausdorff topological groups. (Indeed many authors include "Hausdorff" in their definition of topological group.) We will see one reason for this shortly. However, it is natural to ask: Does every group admit a Hausdorff topology which makes it into a topological group? The answer is obviously "yes"—the discrete topology. But we mention the following problem.

Question. Does every group admit a Hausdorff non-discrete group topology which makes it into a topological group?

Shelah [[359](#)] provided a negative answer, under the assumption of the continuum hypothesis. However in the special case that the group is abelian (that is, commutative) the answer is "yes" and we shall prove this soon. \square

Exercises A5.1

1. Let (G, \mathcal{T}) be a topological group, e its identity element, and k any element of G . If U is any neighbourhood of e , show that there exists an open neighbourhood V of e such that
 - (i) $V = V^{-1}$,
 - (ii) $V^2 \subseteq U$, and
 - (iii) $kVk^{-1} \subseteq U$. (In fact, with more effort you can show that if K is any compact subset of (G, \mathcal{T}) then V can be chosen also to have the property:
 - (iv) for any $k \in K$, $kVk^{-1} \subseteq U$.)

2. (i) Let G be any group and let $\mathcal{N} = \{N\}$ be a family of normal subgroups of G . Show that the family of all sets of the form gN , as g runs through G and N runs through \mathcal{N} is an open subbasis for a topological group topology on G . Such a topology is called a **subgroup topology**.
 - (ii) Prove that every topological group topology on a finite group is a subgroup topology with \mathcal{N} consisting of precisely one normal subgroup.

3. Show that
 - (ii) if (G, \mathcal{T}) is a topological group, then (G, \mathcal{T}) is a regular space;
 - (iii) any regular T_0 -space is Hausdorff, and hence any topological group which is a T_0 -space is Hausdorff.

4. Let (G, \mathcal{T}) be a topological group, A and B subsets of G and g any element of G . Show that
 - (i) If A is open, then gA is open.
 - (ii) If A is open and B is arbitrary, then AB is open.
 - (iii) If A and B are compact, then AB is compact.
 - (iv) If A is compact and B is closed, then AB is closed.
 - (v)* If A and B are closed, then AB need not be closed.

5. Let S be a compact subset of a metrizable topological group G , such that $xy \in S$ if x and y are in S . Show that for each $x \in S$, $xS = S$. (Let y be a cluster point of the sequence x, x^2, x^3, \dots in S and show that $yS = \bigcap_{n=1}^{\infty} x^n S$; deduce that $yxS = yS$.) Hence show that S is a subgroup of G . (Cf. Hewitt and Ross [180], Theorem 9.16.)
6. A topological group G is said to be **ω -narrow** if for any neighbourhood N of the identity e , there exist a countable set $x_n \in G$, $n \in \mathbb{N}$, of members of G such that $G = \bigcup_{n \in \mathbb{N}} Nx_n$. Verify each of the following statements:
- (i) Every countable topological group is ω -narrow.
 - (ii) For each $n \in \mathbb{N}$, \mathbb{R}^n is ω -narrow.
 - (iii) An uncountable discrete topological group is not ω -narrow.
 - (iv) Every topological group which is a Lindelöf space is ω -narrow. In particular every topological group which is compact or a k_ω -space is ω -narrow.
 - (v) Every topological group which is a second countable space is ω -narrow.
 - (vi)* Every separable topological group is ω -narrow.

[Hint. Let U be any open neighbourhood of e . Find a neighbourhood V of e such that $V = V^{-1}$ and $V^2 \subseteq U$. Call a subset S of G **V -disjoint** if $xV \cap yV = \emptyset$, for each distinct pair $x, y \in S$. The set \mathcal{S} of all V -disjoint subsets of G is partially-ordered by set inclusion \subseteq . As the union of any totally-ordered set of V -disjoint sets is a V -disjoint set, use Zorn's Lemma to show there is a maximal element M of the partially-ordered set \mathcal{S} . Verify that $\{mV : m \in M\}$ is a disjoint set of non-empty open sets in G . Verify that in a separable space there is at most a countable number of disjoint open sets and hence M is countable. As M is maximal, show that for every $x \in G$, there exists an $m \in M$ such that $xV \cap mV \neq \emptyset$. Then $x \in mVV^{-1} = mV^2 \subseteq mU$. Deduce that $MU = G$ and so G is ω -narrow.]

A5.2 Subgroups and Quotient Groups of Topological Groups

A5.2.1 Definition. Let G_1 and G_2 be topological groups. A map $f : G_1 \rightarrow G_2$ is said to be a **continuous homomorphism** if it is both a homomorphism of groups and continuous. If f is also a homeomorphism then it is said to be a **topological group isomorphism** or a **topological isomorphism** and G_1 and G_2 are said to be **topologically isomorphic**.

A5.2.2 Example. Let \mathbb{R} be the additive group of real numbers with the usual topology and \mathbb{R}^\times the multiplicative group of positive real numbers with the usual topology. Then \mathbb{R} and \mathbb{R}^\times are topologically isomorphic, where the topological isomorphism $\mathbb{R} \rightarrow \mathbb{R}^\times$ is $x \mapsto e^x$. (Hence we need not mention this group \mathbb{R}^\times again, since, as topological groups, \mathbb{R} and \mathbb{R}^\times are the same.) \square

A5.2.3 Proposition. Let G be a topological group and H a subgroup of G . With its subspace topology, H is a topological group.

Proof. The mapping $(x, y) \mapsto xy$ of $H \times H$ onto H and the mapping $x \mapsto x^{-1}$ of H onto H are continuous since they are restrictions of the corresponding mappings of $G \times G$ and G . \square

A5.2.4 Examples. (i) $\mathbb{Z} \leq \mathbb{R}$; (ii) $\mathbb{Q} \leq \mathbb{R}$. \square

A5.2.5 Proposition. Let H be a subgroup of a topological group G . Then

- (i) the closure \overline{H} of H is a subgroup of G ;
- (ii) if H is a normal subgroup of G , then \overline{H} is a normal subgroup of G ;
- (iii) if G is Hausdorff and H is abelian, then \overline{H} is abelian.

Proof. Exercise \square

A5.2.6 Corollary. Let G be a topological group. Then

- (i) $\overline{\{e\}}$ is a closed normal subgroup of G ; indeed, it is the smallest closed subgroup of G ;
- (ii) if $g \in G$, then $\overline{\{g\}}$ is the coset $g\overline{\{e\}} = \overline{\{e\}}g$;
- (iii) If G is Hausdorff then $\overline{\{e\}} = \{e\}$.

Proof. This follows immediately from [Proposition A5.2.5 \(ii\)](#) by noting that $\{e\}$ is a normal subgroup of G . \square

A5.2.7 Proposition. Any open subgroup H of a topological group G is (also) closed.

Proof. Let $x_i, i \in I$ be a set of right coset representatives of H in G . So $G = \bigcup_{i \in I} Hx_i$, where $Hx_i \cap Hx_j = \emptyset$, for any distinct i and j in the index set I . Since H is open, so is Hx_i open, for each $i \in I$.

Of course for some $i_0 \in I$, $Hx_{i_0} = H$, that is, we have $G = H \cup \left(\bigcup_{i \in J} Hx_i \right)$, where $J = I \setminus \{i_0\}$.

These two terms are disjoint and the second term, being the union of open sets, is open. So H is the complement (in G) of an open set, and is therefore closed in G . \square

Note that the converse of [Proposition A5.2.7](#) is false. For example, \mathbb{Z} is a closed subgroup of \mathbb{R} , but it is not an open subgroup of \mathbb{R} .

A5.2.8 Proposition. Let H be a subgroup of a Hausdorff group G . If H is locally compact, then H is closed in G . In particular this is the case if H is discrete.

Proof. Let K be a compact neighbourhood in H of e . Then there exists a neighbourhood U in G of e such that $U \cap H = K$. In particular, $U \cap H$ is closed in G . Let V be a neighbourhood in G of e such that $V^2 \subseteq U$.

If $x \in \overline{H}$, then as \overline{H} is a group (Proposition A5.2.5), $x^{-1} \in \overline{H}$. So there exists an element $y \in Vx^{-1} \cap H$. We will show that $yx \in H$. As $y \in H$, this will imply that $x \in H$ and hence H is closed, as required.

To show that $yx \in H$ we verify that yx is a limit point of $U \cap H$. As $U \cap H$ is closed this will imply that $yx \in U \cap H$ and so, in particular, $yx \in H$.

Let O be an arbitrary neighbourhood of yx . Then $y^{-1}O$ is a neighbourhood of x , and so $y^{-1}O \cap xV$ is a neighbourhood of x . As $x \in \overline{H}$, there is an element $h \in (y^{-1}O \cap xV) \cap H$. So $yh \in O$. Also $yh \in (Vx^{-1}(xV)) = V^2 \subseteq U$, and $yh \in H$; that is, $yh \in O \cap (U \cap H)$. As O is arbitrary, this says that yx is a limit point of $U \cap H$, as required. \square

A5.2.9 Proposition. Let U be a symmetric neighbourhood of e in a topological group G . Then $H = \bigcup_{n=1}^{\infty} U^n$ is an open (and closed) subgroup of G .

Proof. Clearly H is a subgroup of G .

Let $h \in H$. Then $h \in U^n$, for some n .

So $h \in hU \subseteq U^{n+1} \subseteq H$; that is, H contains the neighbourhood hU of h .

As h was an arbitrary element of H , H is open in G . It is also closed in G , by Proposition A5.2.7. \square

A5.2.10 Corollary. Let U be any neighbourhood of e in a connected topological group G . Then $G = \bigcup_{n=1}^{\infty} U^n$; that is, any connected group is generated by any neighbourhood of e .

Proof. Let V be a symmetric neighbourhood of e such that $V \subseteq U$. By [Proposition A5.2.9](#), $H = \bigcup_{n=1}^{\infty} V^n$ is an open and closed subgroup of G .

As G is connected, $H = G$; that is $G = \bigcup_{n=1}^{\infty} V^n$.

As $V \subseteq U$, $V^n \subseteq U^n$, for each n and so $G = \bigcup_{n=1}^{\infty} U^n$, as required. \square

A5.2.11 Definition. A topological group G is said to be **compactly generated** if there exists a compact subset X of G such that G is the smallest subgroup (of G) containing X .

A5.2.12 Examples.

- (i) \mathbb{R} is compactly generated by $[0, 1]$ (or any other non-trivial compact interval).
- (ii) Of course, any compact group is compactly generated.

A5.2.13 Corollary. Any connected locally compact group is compactly generated.

Proof. Let K be any compact neighbourhood of e . Then by [Corollary A5.2.10](#), $G = \bigcup_{n=1}^{\infty} K^n$; that is, G is compactly generated. \square

A5.2.14 Remark. In due course we shall describe the structure of compactly generated locally compact Hausdorff abelian groups. We now see that this class includes all connected locally compact Hausdorff abelian groups. \square

Notation. By **LCA-group** we shall mean locally compact Hausdorff abelian topological group.

A5.2.15 Proposition. The component of the identity (that is, the largest connected subset containing e) of a topological group is a closed normal subgroup.

Proof. Let C be the component of the identity in a topological group G . As in any topological space components are closed sets, C is closed.

Let $a \in C$. Then $a^{-1}C \subseteq C$, as $a^{-1}C$ is connected (being a homeomorphic image of C) and contains e .

So $\bigcup_{a \in C} a^{-1}C = C^{-1}C \subseteq C$, which implies that C is a subgroup.

To see that C is a normal subgroup, simply note that for each x in G , $x^{-1}Cx$ is a connected set containing e and so $x^{-1}Cx \subseteq C$. \square

A5.2.16 Proposition. Let N be a normal subgroup of a topological group G . If the quotient group G/N is given the quotient topology under the canonical homomorphism $p : G \rightarrow G/N$ (that is, U is open in G/N if and only if $p^{-1}(U)$ is open in G), then G/N becomes a topological group. Further, the map p is not only continuous but also open. (A map is said to be **open** if the image of every open set is open.)

Proof. The verification that G/N with the quotient topology is a topological group is routine. That the map p is continuous is obvious (and true for all quotient maps of topological spaces).

To see that p is an open map, let O be an open set in G . Then $p^{-1}(p(O)) = NO \subseteq G$.

Since O is open, NO is open. (See [Exercises A5.2 #4.](#)) So by the definition of the quotient topology on G/N , $p(O)$ is open in G/N ; that is, p is an open map. \square

A5.2.17 Remarks.

- (i) Note that quotient maps of topological spaces are not necessarily open maps.
- (ii) Quotient maps of topological groups are not necessarily closed maps. For example, if \mathbb{R}^2 denote the product group $\mathbb{R} \times \mathbb{R}$ with the usual topology, and p is the projection of \mathbb{R}^2 onto its first factor \mathbb{R} , then the set $S = \left\{ \left(x, \frac{1}{x} \right) : x \in \mathbb{R}, x \neq 0 \right\}$ is closed in \mathbb{R}^2 and p is a quotient map with $p(S)$ not closed in \mathbb{R} . \square

A5.2.18 Proposition. If G is a topological group and N is a compact normal subgroup of G then the canonical homomorphism $p : G \rightarrow G/N$ is a closed map. The homomorphism p is also an open map.

Proof. If S is a closed subset of G , then $p^{-1}(p(S)) = NS$ which is the product in G of a compact set and a closed set. By [Exercises A5.1 #4](#) then, this product is a closed set. So $p(S)$ is closed in G/N and p is a closed map. As p is a quotient mapping, [Proposition A5.2.16](#) implies that it is an open map. \square

A5.2.19 Definition. A topological space is said to be **totally disconnected** if the component of each point is the point itself.

A5.2.20 Proposition. If G is any topological group and C is the component of the identity, then G/C is a totally disconnected topological group.

Proof. Note that C is a normal subgroup of G and so G/C is a topological group. The proof that G/C is totally disconnected is left as an exercise. \square

A5.2.21 Proposition. If G/N is any quotient group of a locally compact group G , then G/N is locally compact.

Proof. Simply observe that any open continuous image of a locally compact space is locally compact. \square

A5.2.22 Proposition. Let G be a topological group and N a normal subgroup. Then G/N is discrete if and only if N is open. Also G/N is Hausdorff if and only if N is closed.

Proof. This is obvious (noting that a T_1 -group is Hausdorff). \square

Exercises A5.2

1. Let G and H be topological groups and $f : G \rightarrow H$ a homomorphism. Show that f is continuous if and only if it is continuous at the identity; that is, if and only if for each neighbourhood U in H of e , there exists a neighbourhood V in G of e such that $f(V) \subseteq U$.
2. Show that the circle group \mathbb{T} is topologically isomorphic to the quotient group \mathbb{R}/\mathbb{Z} .
3. Let B_1 and B_2 be (real) Banach spaces. Verify that
 - (i) B_1 and B_2 , with the topologies determined by their norms, are topological groups.
 - (ii) If $T : B_1 \rightarrow B_2$ is a continuous homomorphism (of topological groups) then T is a continuous linear transformation. (So if B_1 and B_2 are "isomorphic as topological groups" then they are "isomorphic as topological vector spaces" but not necessarily "isomorphic as Banach spaces".)

4. Let H be a subgroup of a topological group G . Show that H is open in G if and only if H has non-empty interior (that is, if and only if H contains a non-empty open subset of G).
5. Let H be a subgroup of a topological group G . Show that
- (i) \overline{H} is a subgroup of G .
 - (ii) If H is a normal subgroup of G , then \overline{H} is a normal subgroup of G .
 - (iii) If G is Hausdorff and H is abelian, then \overline{H} is abelian.
6. Let Y be a dense subspace of a Hausdorff space X . If Y is locally compact, show that Y is open in X . Hence show that **a locally compact subgroup of a Hausdorff group is closed**.
7. Let C be the component of the identity in a topological group G . Show that G/C is a Hausdorff totally disconnected topological group. Further show that if f is any continuous homomorphism of G into any totally disconnected topological group H , then there exists a continuous homomorphism $g : G/C \rightarrow H$ such that $gp = f$, where p is the projection $p : G \rightarrow G/C$.
8. Show that the commutator subgroup $[G, G]$ of a connected topological group G is connected. ($[G, G]$ is generated by $\{g_1^{-1}g_2^{-1}g_1g_2 : g_1, g_2 \in G\}$.)
9. If H is a totally disconnected normal subgroup of a connected Hausdorff group G , show that H lies in the centre, $Z(G)$, of G (that is, $gh = hg$, for all $g \in G$ and $h \in H$).
- [Hint: Fix $h \in H$ and observe that the map $g \mapsto ghg^{-1}$ takes G into H .]

10. (i) Let G be any topological group. Verify that $G/\overline{\{e\}}$ is a Hausdorff topological

group. Show that if H is any Hausdorff group and $f : G \rightarrow H$ is a continuous homomorphism, then there exists a continuous homomorphism $g : G/\overline{\{e\}} \rightarrow H$ such that $gp = f$, where p is the canonical map $p : G \rightarrow G/\overline{\{e\}}$.

(This result is the usual reason given for studying Hausdorff topological groups rather than arbitrary topological groups. However, the following result which says in effect that all of the topology of a topological group lies in its "Hausdorffization", namely $G/\overline{\{e\}}$, is perhaps a better reason.)

(ii) Let G_i denote the group G with the indiscrete topology and $i : G \rightarrow G_i$ the identity map. Verify that the map $p \times i : G \rightarrow G/\overline{\{e\}} \times G_i$, given by $p \times i(g) = (p(g), i(g))$, is a topological group isomorphism of G onto its image $p \times i(G)$.

11. Show that **every Hausdorff group, H , is topologically isomorphic to a closed subgroup of an arcwise connected, locally arcwise connected Hausdorff group G .** (Consider the set G of all functions $f : [0, 1) \rightarrow H$ such that there is a sequence $0 = a_0 < a_1 < a_2 < \dots < a_n = 1$ with f being constant on each $[a_k, a_{k-1})$. Define a group structure on G by $fg(t) = f(t)g(t)$ and $f^{-1}(t) = (f(t))^{-1}$, where f and $g \in G$ and $t \in [0, 1)$. The identity of G is the function identically equal to e in H . For $\varepsilon > 0$ and any neighbourhood V of e in H let $U(V, \varepsilon)$ be the set of all f such that $\lambda(\{t \in [0, 1) : f(t) \notin V\}) < \varepsilon$, where λ is Lebesgue measure on $[0, 1)$. The set of all $U(V, \varepsilon)$ is an open basis for a group topology on G . The constant functions form a closed subgroup of G topologically isomorphic to H .)

12. Verify the following statements.

- (i) Every subgroup of an ω -narrow topological group is ω -narrow.
- (ii) Let G and H be topological groups and $f : G \rightarrow H$ a continuous homomorphism. If G is an ω -narrow topological group, then H is an ω -narrow topological group.
- (iii) Let I be an index set and for each $i \in I$, let G_i be an ω -narrow topological group. Then the product $\prod_{i \in I} G_i$ is an ω -narrow topological group.
- (iv) [Exercises A5.1 #6\(vi\)](#) says that every separable topological group is an ω -narrow topological group. However, it follows from (iii) above that there exist non-separable ω -narrow topological groups.
- (v) Let the topological group G be a subgroup of a (finite or infinite) product of topological groups each of which is a second countable space. By [Exercises A5.1 #6](#) and (i) and (iii) above, G is an ω -narrow topological group.

[It is proved in Theorem 3.4.23 of Arhangel'skii and Tkachenko [15] that a topological group is ω -narrow if and only if it is topologically isomorphic to a subgroup of a product of second countable topological groups.]

A class \mathfrak{V} of topological groups is said to be a **variety of topological groups** if (i) every subgroup of a member of \mathfrak{V} is a member of \mathfrak{V} (ii) every quotient group of a member of \mathfrak{V} is a member of \mathfrak{V} and (iii) every product of a set of members of \mathfrak{V} is a member of \mathfrak{V} . (See Morris [295].) So we see that the class of ω -narrow topological groups is a variety of topological groups. Other examples are the class of all topological groups and the class of all abelian topological groups.

A5.3 Embedding in Divisible Groups

A5.3.1 Remark. Products of topological spaces are discussed in detail in Chapters 8, 9 and 10. The most important result on products is, of course, Tychonoff's Theorem 10.3.4 which says that any (finite or infinite) product (with the product topology) of compact topological spaces is compact. Further, Theorem 10.3.4 says that a product of topological spaces $\{(X_i, \mathcal{T}_i) : i \in I\}$ is compact only if each of the spaces (X_i, \mathcal{T}_i) is compact.

If each G_i is a group then $\prod_{i \in I} G_i$ has the obvious group structure $(\prod_{i \in I} g_i \cdot \prod_{i \in I} h_i = \prod_{i \in I} (g_i h_i)$, where g_i and $h_i \in G_i$).

If $\{G_i : i \in I\}$ is a family of groups then the **restricted direct product (weak direct product)**, denoted $\prod_{i \in I}^r G_i$, is the subgroup of $\prod_{i \in I} G_i$ consisting of elements $\prod_{i \in I} g_i$, with $g_i = e$, for all but a finite number of $i \in I$.

From now on, if $\{G_i : i \in I\}$ is a family of topological groups then $\prod_{i \in I} G_i$ will denote the direct product with the product topology. Further $\prod_{i \in I}^r G_i$ will denote the restricted direct product with the topology induced as a subspace of $\prod_{i \in I} G_i$. \square

A5.3.2 Proposition. If each $G_i, i \in I$ is a topological group, then $\prod_{i \in I} G_i$ is a topological group. Further $\prod_{i \in I}^r G_i$ is a dense subgroup of $\prod_{i \in I} G_i$.

Proof. Exercise. \square

A5.3.3 Proposition. Let $\{G_i : i \in I\}$ be a family of topological groups. Then

- (i) $\prod_{i \in I} G_i$ is locally compact if and only if each G_i is locally compact and all but a finite number of G_i are compact.
- (ii) $\prod_{i \in I}^r G_i$ is locally compact Hausdorff if and only if each G_i is locally compact Hausdorff and $G_i = \{e\}$ for all but a finite number of G_i .

Proof. Exercise. □

To prove the result we foreshadowed: *every infinite abelian group admits a non-discrete Hausdorff group topology* we need some basic group theory.

A5.3.4 Definition. A group D is said to be **divisible** if for each $n \in \mathbb{N}$, $\{x^n : x \in D\} = D$; that is, every element of D has an n^{th} root.

A5.3.5 Examples. It is easily seen that the groups \mathbb{R} and \mathbb{T} are divisible, but the group \mathbb{Z} is not divisible. □

A5.3.6 Proposition. Let H be a subgroup of an abelian group G . If ϕ is any homomorphism of H into a divisible abelian group D , then ϕ can be extended to a homomorphism Φ of G into D .

Proof. By [Zorn's Lemma 10.2.16](#), it suffices to show that if $x \notin H$, ϕ can be extended to the group $H_0 = \{x^n h : h \in H, n \in \mathbb{Z}\}$.

Case (i). Assume $x^n \notin H$, $n \in \mathbb{N}$. Then define $\Phi(x^n h) = \phi(h)$, for all $n \in \mathbb{Z}$. Clearly Φ is well-defined, a homomorphism, and extends ϕ on H .

Case (ii). Let $k \geq 2$ be the least positive integer n such that $x^n \in H$. So $\phi(x^k) = d \in D$. As D is divisible, there is a $z \in D$ such that $z^k = d$. Define $\Phi(x^n h) = \phi(h)z^n$, for all $n \in \mathbb{Z}$. Clearly Φ is well-defined, a homomorphism and extends ϕ on H . □

A5.3.7 Corollary. If G is an abelian group, then for any g and h in G , with $g \neq h$, there exists a homomorphism $\phi : G \rightarrow \mathbb{T}$ such that $\phi(g) \neq \phi(h)$; that is, ϕ separates points of G .

Proof. Clearly it suffices to show that for each $g \neq e$ in G , there exists a homomorphism $\phi : G \rightarrow \mathbb{T}$ such that $\phi(g) \neq e$.

Case (i). Assume $g^n = e$, and $g^k \neq e$ for $0 < k < n$. Let $H = \{g^m : m \in \mathbb{Z}\}$. Define $\phi : H \rightarrow \mathbb{T}$ by $\phi(g) = \text{an } n^{\text{th}} \text{ root of unity} = r$, say, ($r \neq e$), and $\phi(g^m) = r^m$, for each m . Now extend ϕ to G by [Proposition A5.3.6](#).

Case (ii). Assume $g^n \neq e$, for all $n > 0$. Define $\phi(g) = z$, for any $z \neq e$ in \mathbb{T} . Extend ϕ to H and then, by [Proposition A5.3.6](#), to G . \square

For later use we also record the following corollary of [Proposition A5.3.6](#).

A5.3.8 Proposition. Let H be an open divisible subgroup of an abelian topological group G . Then G is topologically isomorphic to $H \times G/H$. (Clearly G/H is a discrete topological group.)

Proof. Exercise. \square

A5.3.9 Theorem. If G is any infinite abelian group, then G admits a non-discrete Hausdorff group topology.

Proof. Let $\{\phi_i : i \in I\}$ be the family of distinct homomorphisms of G into \mathbb{T} . Put $H = \prod_{i \in I} T_i$, where each $T_i = \mathbb{T}$. Define a map $f : G \rightarrow H = \prod_{i \in I} T_i$ by putting $f(g) = \prod_{i \in I} \phi_i(g)$. Since each ϕ_i is a homomorphism, f is also a homomorphism. By [Corollary A5.3.7](#), f is also one-one; that is, G is isomorphic to the subgroup $f(G)$ of H .

As H is a Hausdorff topological group, $f(G)$, with the topology induced from H , is also a Hausdorff topological group. It only remains to show that $f(G)$ is not discrete.

Suppose $f(G)$ is discrete. Then, by [Proposition A5.2.8](#), $f(G)$ would be a closed subgroup of H . But by [Tychonoff's Theorem 10.3.4](#), H is compact and so $f(G)$ would be compact; that is, $f(G)$ would be an infinite discrete compact space—which is impossible. So we have a contradiction, and thus $f(G)$ is not discrete. \square

A5.3.10 Remark. [Corollary A5.3.7](#) was essential to the proof of [Theorem A5.3.9](#). This Corollary is a special case of a more general theorem which will be discussed later. We state the result below.

A5.3.11 Theorem. If G is any LCA-group, then for any g and h in G , with $g \neq h$, there exists a continuous homomorphism $\phi : G \rightarrow \mathbb{T}$ such that $\phi(g) \neq \phi(h)$.

Exercises A5.3

1. If $\{G_i : i \in I\}$ is a family of topological groups, show that
 - (i) $\prod_{i \in I} G_i$ is a topological group;
 - (ii) $\prod_{i \in I}^r G_i$ is a dense subgroup of $\prod_{i \in I} G_i$;
 - (iii) $\prod_{i \in I} G_i$ is locally compact if and only if each G_i is locally compact and all but a finite number of G_i are compact;
 - (iv) $\prod_{i \in I}^r G_i$ is locally compact Hausdorff if and only if each G_i is locally compact Hausdorff and $G_i = \{e\}$ for all but a finite number of G_i .
2. Show that if G is an abelian topological group with an open divisible subgroup H , then G is topologically isomorphic to $H \times G/H$.
3. Let G be a torsion-free abelian group (that is, $g^n \neq e$ for each $g \neq e$ in G , and each $n \in \mathbb{N}$). Show that if g and h are in G with $g \neq h$, then there exists a homomorphism ϕ of G into \mathbb{R} such that $\phi(g) \neq \phi(h)$.

4. Let G be a locally compact totally disconnected topological group.

(i) Show that there is a neighbourhood base of the identity consisting of compact open subgroups.

(Hint: You may assume that any locally compact Hausdorff totally disconnected topological space has a base for its topology consisting of compact open sets.)

(ii) If G is compact, show that the "subgroups" in (i) can be chosen to be normal.

(iii) Hence show that any compact totally disconnected topological group is topologically isomorphic to a closed subgroup of a product of finite discrete groups.

(Hint: Let $\{A_i : i \in I\}$ be a base of neighbourhoods of the identity consisting of open normal subgroups. Let $\phi_i : G \rightarrow G/A_i$, $i \in I$, be the canonical homomorphisms, and define $\Phi : G \rightarrow \prod_{i \in I} (G/A_i)$ by putting

$$\Phi(g) = \prod_{i \in I} \phi_i(g).$$

5. Let $f : \mathbb{R} \rightarrow \mathbb{T}$ be the canonical map and θ any irrational number. On the topological space $G = \mathbb{R}^2 \times \mathbb{T}^2$ define an operation.

$$(x_1, x_2, t_1, t_2) \cdot (x'_1, x'_2, t'_1, t'_2) = (x_1 + x'_1, x_2 + x'_2, t_1 + t'_1 + f(x_2 x'_1), t_2 + t'_2 + f(\theta x_2 x'_1)).$$

Show that, with this operation, G is a topological group and that the commutator subgroup of G is not closed in G . (The commutator subgroup of a group G is the subgroup of G generated by the set $\{g^{-1}h^{-1}gh : g, h \in G\}$.)

6. Let I be a set directed by a partial ordering \geq . For each $i \in I$, let there be given a Hausdorff topological group G_i . Assume that for each i and j in I such that $i < j$, there is an open continuous homomorphism f_{ji} of G_j into G_i . Assume further that if $i < j < k$, then $f_{ki} = f_{ji}f_{kj}$. The object consisting of I , the groups G_i and the mappings f_{ji} , is called an **inverse mapping system** or a **projective mapping system**. The subset H of the product group $G = \prod_{i \in I} G_i$

consisting of all $\prod_{i \in I} (x_i)$ such that if $i < j$ then $x_i = f_{ji}(x_j)$ is called the injective limit or **projective limit** of the inverse mapping system. Show that H is a closed subgroup of G .

A5.4 Baire Category and Open Mapping Theorems

A5.4.1 Theorem. (Baire Category Theorem for Locally Compact Spaces) If X is a locally compact regular space, then X is not the union of a countable collection of closed sets all having empty interior.

Proof. Suppose that $X = \bigcup_{n=1}^{\infty} A_n$, where each A_n is closed and $\text{Int}(A_n) = \emptyset$, for each n . Put $D_n = X \setminus A_n$. Then each D_n is open and dense in X . We shall show that $\bigcap_{n=1}^{\infty} D_n \neq \emptyset$, contradicting the equality $X = \bigcup_{n=1}^{\infty} A_n$.

Let U_0 be a non-empty open subset of X such that $\overline{U_0}$ is compact. As D_1 is dense in X , $U_0 \cap D_1$ is a non-empty open subset of X . Using the regularity of X we can choose a non-empty open set U_1 such that $\overline{U_1} \subseteq U_0 \cap D_1$. Inductively define U_n so that each U_n is a non-empty open set and $\overline{U_n} \subseteq U_{n-1} \cap D_n$. Since $\overline{U_0}$ is compact and each $\overline{U_n}$ is non-empty, $\bigcap_{n=1}^{\infty} \overline{U_n} \neq \emptyset$. This implies $\bigcap_{n=1}^{\infty} D_n \neq \emptyset$. This contradiction the supposition is false and so the theorem is proved. \square

A5.4.2 Remark. We saw that the Baire Category Theorem was proved for complete metric spaces in [Theorem 6.5.1](#). The above Theorem also remains valid if "locally compact regular" is replaced by "locally compact Hausdorff".

A5.4.3 Corollary. Let G be any countable locally compact Hausdorff topological group. Then G has the discrete topology.

Proof. Exercise. \square

A5.4.4 Theorem. (Open Mapping Theorem for Locally Compact Groups) Let G be a locally compact group which is σ -compact; that is, $G = \bigcup_{n=1}^{\infty} A_n$, where each A_n is compact. Let f be any continuous homomorphism of G onto a locally compact Hausdorff group H . Then f is an open mapping.

Proof. Let \mathcal{U} be the family of all symmetric neighbourhoods of e in G and \mathcal{U}' the family of all neighbourhoods of e in H . It suffices to show that for every $U \in \mathcal{U}$ there is a $U' \in \mathcal{U}'$ such that $U' \subseteq f(U)$.

Let $U \in \mathcal{U}$. Then there exists a $V \in \mathcal{U}$ having the property that \bar{V} is compact and $(\bar{V})^{-1}\bar{V} \subseteq U$. The family of sets $\{xV : x \in G\}$ is then an open cover of G and hence also of each compact set A_n . So a finite collection of these sets will cover any given A_n . So a finite collection of these sets will cover any given A_n . Thus there is a countable collection $\{x_n V : n \in \mathbb{N}\}$ which covers G .

So $H = \bigcup_{n=1}^{\infty} f(x_n V) = \bigcup_{n=1}^{\infty} f(x_n \bar{V}) = \bigcup_{n=1}^{\infty} f(x_n) f(\bar{V})$. This expresses H as a countable union of closed sets, and by the [Baire Category Theorem A5.4.1](#), one of them must have non-empty interior; that is, $f(x_m) f(\bar{V})$ contains an open set. Then $f(\bar{V})$ contains an open subset V' of H .

To complete the proof select any point x' of V' and put $U' = (x')^{-1}V'$. Then we have

$$U' = (x')^{-1}V' \subseteq (V')^{-1}V' \subseteq (f(\bar{V}))^{-1}f(\bar{V}) = f((\bar{V})^{-1}\bar{V}) \subseteq f(U),$$

as required. □

A5.4.5 Remark. We met the Open Mapping Theorem for Banach Spaces in [Theorem 6.5.5](#)

Exercises A5.4

1. Show that any countable locally compact Hausdorff group has the discrete topology.

2. Show that the Open Mapping Theorem A5.4.4 does not remain valid if either of the conditions “ σ -compact” or “onto” is deleted.
3. Show that any continuous homomorphism of a compact group onto a Hausdorff group is an open mapping.
4. Show that for any $n \in \mathbb{N}$, the compact topological group \mathbb{T}^n is topologically isomorphic to the quotient group $\mathbb{R}^n/\mathbb{Z}^n$.

5. (i) Let ϕ be a homomorphism of a topological group G into a topological group H . If X is a non-empty subset of G such that the restriction $\phi : X \rightarrow H$ is an open map, show that $\phi : G \rightarrow H$ is also an open map.

[Hint: For any subset U of G , $\phi(U) = \bigcup_{g \in G} \phi(U \cap gX)$.]

- (ii) Hence show that if G and H are locally compact Hausdorff groups with ϕ a continuous homomorphism $: G \rightarrow H$ such that for some compact subset K of G , $\phi(K)$ generates H algebraically, then ϕ is an open map.

[Hint: Show that there is a compact neighbourhood U of e such that $K \subseteq U$. Put $X =$ the subgroup generated algebraically by U .]

6. Let G and H be topological groups, and let η be a homomorphism of H into the group of automorphisms of G . Define a group structure on the set $G \times H$ by putting

$$(g_1, h_1) \cdot (g_2, h_2) = (g_1 \eta(h_1)(g_2), h_1 h_2).$$

Further, let $(g, h) \mapsto \eta(h)(g)$ be a continuous map of $G \times H$ onto G . Show that

- (i) Each $\eta(h)$ is a homeomorphism of G onto itself; and
- (ii) With the product topology and this group structure $G \times H$ is a topological group. (It is called the **semidirect product** of G by H that is determined by η , and is denoted by $G \rtimes_{\eta} H$.)

7. (i) Let G be a σ -compact locally compact Hausdorff topological group with N a closed normal subgroup of G and H a closed subgroup of G such that $G = NH$ and $N \cap H = \{e\}$. Show that G is topologically isomorphic to an appropriately defined semidirect product $N \rtimes_{\eta} H$.
[Hint: Let $\eta(h)(n) = h^{-1}nh$, $h \in H$ and $n \in N$.]
- (ii) If H is also normal, show that G is topologically isomorphic to $N \times H$.
- (iii) If A and B are closed compactly generated subgroups of a locally compact Hausdorff abelian topological group G such that $A \cap B = \{e\}$ and $G = AB$, show that G is topologically isomorphic to $A \times B$.
8. Let G and H be Hausdorff topological groups and f a continuous homomorphism of G into H . If G has a neighbourhood U of e such that \bar{U} is compact and $f(U)$ is a neighbourhood of e in H , show that f is an open map.

A5.5 Subgroups and Quotient Groups of \mathbb{R}^n

In this section we expose the structure of the closed subgroups and Hausdorff quotient groups of \mathbb{R}^n , $n \geq 1$.

Notation. Unless explicitly stated otherwise, for the remainder of this chapter we shall focus our attention on abelian groups which will in future be written additively. However, we shall still refer to the product of two groups A and B (and denote it by $A \times B$) rather than the sum of the two groups. We shall also use A^n to denote the product of n copies of A and $\prod_{i \in I} A_i$ for the product of the groups A_i , $i \in I$. The identity of an abelian group will be denoted by 0 .

A5.5.1 Proposition. Every non-discrete subgroup G of \mathbb{R} is dense.

Proof. We have to show that for each $x \in \mathbb{R}$ and each $\varepsilon > 0$, there exists an element $g \in G \cap [x - \varepsilon, x + \varepsilon]$.

As G is not discrete, 0 is not an isolated point. So there exists an element $x_\varepsilon \in (G \setminus \{0\}) \cap [0, \varepsilon]$. Then the intervals $[nx_\varepsilon, (n+1)x_\varepsilon]$, $n = 0, \pm 1, \pm 2, \dots$ cover \mathbb{R} and are of length $\leq \varepsilon$. So for some n , $nx_\varepsilon \in [x - \varepsilon, x + \varepsilon]$ and of course $nx_\varepsilon \in G$. \square

A5.5.2 Proposition. Let G be a closed subgroup of \mathbb{R} . Then $G = \{0\}$, $G = \mathbb{R}$ or G is a discrete group of the form $a\mathbb{Z} = \{0, a, -a, 2a, -2a, \dots\}$, for some $a > 0$.

Proof. Assume $G \neq \mathbb{R}$. As G is closed, and hence not dense in \mathbb{R} , G must be discrete. If $G \neq \{0\}$, then G contains some positive real number b . So $[0, b] \cap G$ is a closed non-empty subset of the compact set $[0, b]$. Thus $[0, b] \cap G$ is compact and discrete. Hence $[0, b] \cap G$ is finite, and so there exists a least element $a > 0$ in G .

For each $x \in G$, let $\left[\frac{x}{a}\right]$ denote the integer part of $\frac{x}{a}$. Then $x - \left[\frac{x}{a}\right]a \in G$ and $0 \leq x - \left[\frac{x}{a}\right]a < a$. So $x - \left[\frac{x}{a}\right]a = 0$; that is, $x = na$, for some $n \in \mathbb{Z}$, as required. \square

A5.5.3 Corollary. If $a, b \in \mathbb{R}$ then $\text{gp}\{a, b\}$, the subgroup of \mathbb{R} generated by $\{a, b\}$, is closed if and only if a and b are rationally dependent. [Real numbers a and b are said to be **rationally dependent** if there exists integers n and m such that $na = bm$.]

Proof. Exercise. \square

A5.5.4 Examples. $\text{gp}\{1, \sqrt{2}\}$ and $\text{gp}\{\sqrt{2}, \sqrt{3}\}$ are dense in \mathbb{R} . \square

A5.5.5 Corollary. Every proper Hausdorff quotient group of \mathbb{R} is topologically isomorphic to \mathbb{T} .

Proof. If \mathbb{R}/G is a proper Hausdorff quotient group of \mathbb{R} , then, by [Proposition A5.2.22](#), G is a closed subgroup of \mathbb{R} . By [Proposition A5.5.2](#), G is of the form $a\mathbb{Z}$, $a > 0$. Noting that the map $x \rightarrow \frac{1}{a}x$ is a topological group isomorphism of \mathbb{R} onto itself such that $a\mathbb{Z}$ maps to \mathbb{Z} , we see that $\mathbb{R}/a\mathbb{Z}$ is topologically isomorphic to \mathbb{R}/\mathbb{Z} which, we know, is topologically isomorphic to \mathbb{T} . \square

A5.5.6 Corollary. Every proper closed subgroup of \mathbb{T} is finite.

Proof. Identify \mathbb{T} with the quotient group \mathbb{R}/\mathbb{Z} and let $p: \mathbb{R} \rightarrow \mathbb{R}/\mathbb{Z}$ be the canonical quotient homomorphism. If G is any proper closed subgroup of \mathbb{R}/\mathbb{Z} then $p^{-1}(G)$ is a proper closed subgroup of \mathbb{R} . So $p^{-1}(G)$ is discrete. By [Proposition A5.2.16](#), the restriction $p: p^{-1}(G) \rightarrow G$ is an open map, so we see that G is discrete. As G is also compact, it is finite. \square

We now proceed to the investigation of closed subgroups of \mathbb{R}^n , for $n \geq 1$. Here we use the fact that \mathbb{R}^n is a vector space over the field of real numbers.

Notation. If A is a subset of \mathbb{R}^n , we denote by $\text{sp}_{\mathbb{R}}(A)$ the subgroup

$$\{\alpha_1 a_1 + \cdots + \alpha_m a_m : \alpha_i \in \mathbb{R}, a_i \in A, i = 1, \dots, m, m \text{ a positive integer}\};$$

and by $\text{sp}_{\mathbb{Q}}(A)$ the subgroup

$$\{\alpha_1 a_1 + \cdots + \alpha_m a_m : \alpha_i \in \mathbb{Q}, a_i \in A, i = 1, \dots, m, m \text{ a positive integer}\};$$

and by $\text{gp}(A)$ the subgroup of \mathbb{R}^n generated by A .

Clearly $\text{gp}(A) \subseteq \text{sp}_{\mathbb{Q}}(A) \subseteq \text{sp}_{\mathbb{R}}(A)$. We define $\text{rank}(A)$ to be the dimension of the vector space $\text{sp}_{\mathbb{R}}(A)$.

A5.5.7 Proposition. If $\{a_1, \dots, a_m\}$ is a linearly independent subset of \mathbb{R}^n , then $\text{gp}\{a_1, \dots, a_m\}$ is topologically isomorphic to \mathbb{Z}^m .

Proof. Choose elements a_{m+1}, \dots, a_n so that $\{a_1, \dots, a_m, a_{m+1}, \dots, a_n\}$ is a basis for \mathbb{R}^n . It is clear that if $\{c_1, \dots, c_n\}$ is the canonical basis for \mathbb{R}^n , then $\text{gp}\{c_1, \dots, c_m\}$ is topologically isomorphic to \mathbb{Z}^m . By [Exercises A5.5#2](#), every linear transformation of \mathbb{R}^n onto itself is a homeomorphism. So the linear map taking a_i to c_i , $i = 1, \dots, n$, yields a topological group isomorphism of $\text{gp}\{a_1, \dots, a_m\}$ onto $\text{gp}\{c_1, \dots, c_m\} = \mathbb{Z}^m$. \square

A5.5.8 Proposition. Let G be a discrete subgroup of \mathbb{R}^n of rank p , and $a_1, \dots, a_p \in G$ a basis for $\text{sp}_{\mathbb{R}}(G)$. Let P be the closed parallelotope with centre 0 and basis vectors a_1, \dots, a_p ; that is, $P = \left\{ \sum_{i=1}^p r_i a_i : -1 \leq r_i \leq 1, i = 1, \dots, p \right\}$. Then $G \cap P$ is finite and $\text{gp}(G \cap P) = G$. Further, every point in G is a linear combination of $\{a_1, \dots, a_p\}$ with rational coefficients; that is, $G \subseteq \text{sp}_{\mathbb{Q}}\{a_1, \dots, a_p\}$.

Proof. As P is compact and G is discrete (and closed in \mathbb{R}^n), $G \cap P$ is discrete and compact, and hence finite.

Now $G \subseteq \text{sp}_{\mathbb{R}}\{a_1, \dots, a_p\}$ implies that each $x \in G$ can be written as $x = \sum_{i=1}^p t_i a_i$, $t_i \in \mathbb{R}$. For each positive integer m , the point

$$z_m = mx - \sum_{i=1}^p [mt_i] a_i = \sum_{i=1}^p (mt_i - [mt_i]) a_i$$

where $[\]$ denotes "integer part of", belongs to G . As $0 \leq mt_i - [mt_i] < 1$, $z_m \in P$. Hence $x = z_1 + \sum_{i=1}^p [t_i] a_i$, which says that $\text{gp}(G \cap P) = G$.

Further, as $G \cap P$ is finite there exist integers h and k such that $z_h = z_k$. So $(h - k)t_i = [ht_i] - [kt_i]$, $x \in \text{sp}_{\mathbb{Q}}\{a_1, \dots, a_p\}$. \square

A5.5.9 Corollary. Let $\{a_1, \dots, a_p\}$ be a linearly independent subset of \mathbb{R}^n , and $b = \sum_{i=1}^p t_i a_i$, $t_i \in \mathbb{R}$. Then $\text{gp}\{a_1, \dots, a_p, b\}$ is discrete if and only if t_1, \dots, t_p are rational numbers.

Proof. Exercise. \square

A5.5.10 Theorem. Every discrete subgroup G of \mathbb{R}^n of rank p is generated by p linearly independent vectors, and hence is topologically isomorphic to \mathbb{Z}^p .

Proof. Since G is of rank p , $G \subseteq \text{sp}_{\mathbb{R}}\{a_1, \dots, a_p\}$, where a_1, \dots, a_p are linearly independent elements of G . By Proposition A5.5.8, $G = \text{gp}\{g_1, \dots, g_r\}$ where each $g_i \in \text{sp}_{\mathbb{Q}}\{a_1, \dots, a_p\}$. So there exists a $d \in \mathbb{Z}$ such that $g_i \in \text{gp}\left\{\frac{1}{d}a_1, \dots, \frac{1}{d}a_p\right\}$, $i = 1, \dots, r$.

Now, if $\{b_1, \dots, b_p\}$ is a linearly independent subset of G , then $b_i = \sum \beta_{ij}a_j$, where the determinant, $\det(\beta_{ij}) \neq 0$, and $\beta_{ij} \in \frac{1}{d}\mathbb{Z}$. So $\det(\beta_{ij}) \in \frac{1}{d^p}\mathbb{Z}$. So out of all such $\{b_1, \dots, b_p\}$ there exists one with $|\det(\beta_{ij})|$ minimal. Let this set be denoted by $\{b_1, \dots, b_p\}$. We claim that $G = \text{gp}\{b_1, \dots, b_p\}$ and hence is topologically isomorphic to \mathbb{Z}^p .

Suppose $G \neq \text{gp}\{b_1, \dots, b_p\}$. Then there exists an element $g \in G$ with $g = \sum_{i=1}^p \lambda_i b_i$ and not all $\lambda_i \in \mathbb{Z}$. Without loss of generality we can assume that $\lambda_1 = \frac{r}{s}$, $r \neq 0$ and $s > 1$. Since $b_1 \in G$ we can also assume that $|\lambda_1| < 1$ (by subtracting multiples of b_1 , if necessary). Then putting $b'_1 = g$, $b'_i = b_i$, $i = 2, \dots, p$ and $b'_i = \sum \beta'_{ij}a_j$ we see that

$$\det(\beta'_{ij}) = \det \begin{pmatrix} \lambda_1 & 0 & 0 & \dots & 0 \\ \lambda_2 & 1 & 0 & \dots & 0 \\ \lambda_3 & 0 & 1 & \dots & 0 \\ \vdots & \vdots & \vdots & \ddots & \vdots \\ \lambda_p & 0 & 0 & \dots & 1 \end{pmatrix} \det(\beta_{ij}) = \lambda_1 \det(\beta_{ij}).$$

As $|\lambda_1| < 1$ this means that $|\det(\beta'_{ij})| < |\det(\beta_{ij})|$, which is a contradiction. \square

A5.5.11 Proposition. Every non-discrete closed subgroup H of \mathbb{R}^n , $n \geq 1$, contains a line through zero.

Proof. As H is non-discrete there exists a sequence h_1, h_2, \dots of points in H converging to 0, with each $h_n \neq 0$. Let C be an open cube with centre 0 containing all the h_n . Let m_n denote the largest integer $m > 0$ such that $mh_n \in C$. The points $m_n h_n$, $n = 1, 2, \dots$ lie in a compact set \overline{C} and therefore have a cluster point $a \in \overline{C} \cap H$.

If $\|m_n h_n - a\| \leq \varepsilon$ we have $\|(m_n + 1)h_n - a\| \leq \varepsilon + \|h_n\|$, where $\|\cdot\|$ denotes the usual norm in \mathbb{R}^n . Since $h_n \rightarrow 0$ as $n \rightarrow \infty$ it follows that a is also a cluster point of the sequence $(m_n + 1)h_n$, $n = 1, 2, \dots$, whose points belong to the closed set $\mathbb{R}^n \setminus C$. Hence $a \in \overline{C} \cap (\mathbb{R}^n \setminus C)$ —the boundary of C , which implies $a \neq 0$.

Let t be any real number. Since $|tm_n - [tm_n]| < 1$, the relation $\|m_n h_n - a\| \leq \varepsilon$ implies that $\|[tm_n]h_n - ta\| \leq |t|\varepsilon + \|h_n\|$; since $h_n \rightarrow 0$ as $n \rightarrow \infty$, ta is a limit point of the sequence $[tm_n]h_n$, $n = 1, 2, \dots$. But the points of this sequence belong to H and so $ta \in H$, since H is closed. So H contains the line through $a \neq 0$ and 0. \square

A5.5.12 Theorem. Let G be a closed subgroup of \mathbb{R}^n , $n \geq 1$. Then there are (closed) vector subspaces U , V and W of \mathbb{R}^n such that

- (i) $\mathbb{R}^n = U \times V \times W$
- (ii) $G \cap U = U$
- (iii) $G \cap V$ is discrete
- (iv) $G \cap W = \{0\}$
- (v) $G = (G \cap U) \times (G \cap V)$.

Proof. Let U be the union of all lines through 0 lying entirely in G . We claim that U is a vector subspace of \mathbb{R}^n .

To see this let x and y be in U and λ, μ and $\delta \in \mathbb{R}$. Then $\delta\lambda x$ is in U and hence also in G . Similarly $\delta\mu y \in G$. So $\delta(\lambda x + \mu y) = \delta\lambda x + \delta\mu y \in G$. As this is true for all $\delta \in \mathbb{R}$, we have that $\lambda x + \mu y \in U$. So U is a vector subspace of \mathbb{R}^n , and $G \cap U = U$.

Let U' be any complementary subspace of U ; that is, $\mathbb{R}^n = U \times U'$. So if $g \in G$, then $g = h + k$, $h \in U$, $k \in U'$. As $U \subseteq G$, $h \in G$ so $k = g - h \in G$. Hence $G = U \times (G \cap U')$.

Put $V = \text{sp}_{\mathbb{R}}(G \cap U')$ and W equal to a complementary subspace in U' of V . So $G \cap W = \{0\}$. Clearly $G \cap V$ contains no lines through 0, which by Proposition A5.5.11, implies that $G \cap V$ is discrete. \square

A5.5.13 Theorem. Let G be a closed subgroup of \mathbb{R}^n , $n \geq 1$. If r equals the rank of G (that is, $\text{sp}_{\mathbb{R}}(G)$ has dimension r) then there exists a basis a_1, \dots, a_n of \mathbb{R}^n such that

$$G = \text{sp}_{\mathbb{R}}\{a_1, \dots, a_p\} \times \text{gp}\{a_{p+1}, \dots, a_r\}.$$

So G is topologically isomorphic to $\mathbb{R}^p \times \mathbb{Z}^{r-p}$ and the quotient group \mathbb{R}^n/G is topologically isomorphic to $\mathbb{T}^{r-p} \times \mathbb{R}^{n-r}$. \square

Proof. Exercise. \square

Before stating the next theorem let us record some facts about free abelian groups.

A5.5.14 Definition. A group F is said to be a **free abelian group** if it is the restricted direct product of a finite or infinite number of infinite cyclic groups. Each of these infinite cyclic groups has a single generator and the set S of these generators is said to be a **basis** of F .

A5.5.15 Remarks.

- (i) It can be shown that an abelian group F is a free abelian group with basis S if and only if S is a subset of F with the property that every map f of S into any abelian group G can be extended uniquely to a homomorphism of F into G .
- (ii) One consequence of (i) is that any abelian group G is a quotient group of some free abelian group. (Let F be the free abelian group with basis S of the same cardinality as G . Then there is a bijection ϕ of S onto G . Extend this map to a homomorphism of F onto G .)
- (iii) [Proposition A5.5.7](#) together with [Theorem A5.5.10](#) show that any subgroup of \mathbb{Z}^n is isomorphic to \mathbb{Z}^m , for some m . In other words, any subgroup of a free abelian group with finite basis is a free abelian group with finite basis. It can be shown that any subgroup of a free abelian group is a free abelian group. For details see A.G. Kurosh [[250](#)].
- (iv) Finally, we record that if the abelian group G admits a homomorphism ϕ onto a free abelian group F then G is isomorphic to $F \times A$, where A is the kernel of ϕ . (Note that it suffices to produce a homomorphism θ of F into G such that $\phi\theta$ is the identity map of F . To produce θ , let S be a basis of F and for each $s \in S$ choose a $g_s \in G$ such that $\phi(g_s) = s$. As F is a free abelian group the map $s \rightarrow g_s$ of S into G can be extended to a homomorphism θ of F into G . Clearly $\phi\theta$ acts identically on F .)

□

A5.5.16 Theorem. Let $H = V \times F$, where V is a divisible abelian Hausdorff group and F is a discrete free abelian group. If G is a closed subgroup of H , then there exists a discrete free abelian subgroup F' of H isomorphic to F such that (i) $H = V \times F'$, and (ii) $G = (G \cap V) \times (G \cap F')$.

Proof. Let $\pi_1 : H \rightarrow V$ and $\pi_2 : H \rightarrow F$ be the projections. The restriction of π_2 to G is a homomorphism from G to F with kernel $G \cap V$. Since F is a free abelian group, and every subgroup of a free abelian group is a free abelian group, $G/(G \cap V)$ is free abelian, and therefore, by the above Remark (iv), G is algebraically isomorphic to $(G \cap V) \times C$, where C is a free abelian subgroup of G .

Let p_1 and p_2 be the restrictions of π_1 and π_2 to C , respectively. Then p_2 is one-one as $C \cap V = C \cap G \cap V = \{0\}$.

$$\begin{array}{ccc} C & \xrightarrow{p_2} & F \\ p_1 \downarrow & \nearrow \theta & \\ V & & \end{array}$$

We can define a homomorphism $\theta : p_2(C) \rightarrow V$ by putting $\theta(p_2(c)) = p_1(c)$ and then use [Proposition A5.3.6](#) to extend θ to a homomorphism of F into the divisible group V . So $\theta_{p_2} = p_1$. If we now define a homomorphism $\phi : F \rightarrow H$ by $\phi(x) = \theta(x) + x$ and put $F' = \phi(F)$ we have that $H = V \times F'$, algebraically; the decomposition being given by

$$v + f = [v - \theta(f)] + [\theta(f) + f], v \in V \text{ and } f \in F.$$

Also $C \subseteq F'$, since for each c in C we have

$$c = p_1(c) + p_2(c) = \theta(p_2(c)) + p_2(c) = \phi(p_2(c)) \in \phi(F) = F'.$$

So (i) and (ii) are satisfied algebraically.

Now $\phi : F \rightarrow F'$ is an algebraic isomorphism and since ϕ^{-1} is induced by π_2 , ϕ^{-1} is continuous. But F is discrete, so ϕ is a homeomorphism and F' is a discrete free abelian group.

To show that H has the product topology with respect to the decomposition $H = V \times F'$, it suffices to show that the corresponding projections $\pi'_1 : H \rightarrow V$ and $\pi'_2 : H \rightarrow F'$ are continuous. But this is clearly the case since $\pi'_1(h) = \pi_1(h) - \theta(\pi_2(h))$ and $\pi'_2(h) = \pi_2(h) + \theta(\pi_2(h))$, for each $h \in H$. Hence the decomposition $G = (G \cap V) \times (G \cap F')$ also has the product topology. \square

A5.5.17 Corollary. Let G be a closed subgroup of $\mathbb{R}^n \times \mathbb{Z}^m$. Then G is topologically isomorphic to $\mathbb{R}^a \times \mathbb{Z}^b$, where $a \leq n$ and $a + b \leq n + m$. Further, $(\mathbb{R}^n \times \mathbb{Z}^m)/G$ is topologically isomorphic to $\mathbb{R}^c \times \mathbb{T}^d \times D$, where D is a discrete finitely generated abelian group (with $f \leq m$ generators) and $c + d \leq n$.

Proof. Exercise. \square

A5.5.18 Corollary. Let G be a closed subgroup of $\mathbb{R}^n \times \mathbb{T}^m \times D$, where D is a discrete abelian group. Then G is topologically isomorphic to $\mathbb{R}^a \times \mathbb{T}^b \times D'$, where D' is a discrete group and $a + b \leq n + m$. Further $(\mathbb{R}^n \times \mathbb{T}^m \times D)/G$ is topologically isomorphic to $\mathbb{R}^c \times \mathbb{T}^d \times D''$, where D'' is a discrete group and $c + d \leq n + m$.

Proof. Let F be a discrete free abelian group with D as a quotient group. (See [Remarks A5.5.15](#).) Then there is a natural quotient homomorphism p of $\mathbb{R}^{n+m} \times F$ onto $\mathbb{R}^n \times \mathbb{T}^m \times D$. So G is a quotient group of $p^{-1}(G) \leq \mathbb{R}^{n+m} \times F$. Now [Theorem A5.5.16](#) together with [Theorem A5.5.13](#) describe both $p^{-1}(G)$ and the kernel of the map of $p^{-1}(G)$ onto G , and yield the result. \square

A5.5.19 Remark. In [Corollary A5.5.18](#) we have not said that $a \leq n$, $b \leq m$ and $c \leq n$. These inequalities are indeed true. They follow from the above and the Pontryagin-van Kampen Duality Theorem.

A5.5.20 Corollary. Let G be a closed subgroup of \mathbb{T}^n . Then G is topologically isomorphic to $\mathbb{T}^a \times D$ where D is a finite discrete group and $a \leq n$.

Proof. Exercise. □

A5.5.21 Definition. The topological groups G and H are said to be **locally isomorphic** if there are neighbourhoods V of e in G and U of e in H and a homeomorphism f of V onto U such that if x, y and xy all belong to V then $f(xy) = f(x)f(y)$.

A5.5.22 Example. \mathbb{R} and \mathbb{T} are obviously locally isomorphic topological groups. □

A5.5.23 Proposition. If D is a discrete normal subgroup of a topological group G , then G and G/D are locally isomorphic.

Proof. Exercise. □

A5.5.24 Lemma. Let U be a neighbourhood of 0 in an abelian topological group G and V be a neighbourhood of 0 in \mathbb{R}^n , $n \geq 1$. If there is a continuous map f of V onto U such that $x \in V$, $y \in V$ and $x + y \in V$ implies $f(x + y) = f(x) + f(y)$, then f can be extended to a continuous homomorphism of \mathbb{R}^n onto the open subgroup of G generated by U .

Proof. Exercise □

A5.5.25 Theorem. Let G be a Hausdorff abelian topological group locally isomorphic to \mathbb{R}^n , $n \geq 1$. Then G is topologically isomorphic to $\mathbb{R}^a \times \mathbb{T}^b \times D$, where D is a discrete group and $a + b = n$.

Proof. By [Lemma A5.5.24](#) there is a continuous homomorphism f of \mathbb{R}^n onto an open subgroup H of G . As G is locally isomorphic to \mathbb{R}^n , it has a compact neighbourhood of 0 and so is locally compact. Hence H is locally compact and the [Open Mapping Theorem A5.4.4](#) says that f is an open map; that is, H is a quotient group of \mathbb{R}^n . Further the kernel K of f is discrete since otherwise there would be elements $x \neq 0$ of K arbitrarily close to 0 such that $f(x) = 0$, which is false as f maps a neighbourhood of 0 homeomorphically into G . So [Theorem A5.5.13](#) tells us that H is topologically isomorphic to $\mathbb{R}^a \times \mathbb{T}^b$, with $a + b = n$.

Now H is an open divisible subgroup of G which, by [Proposition A5.3.8](#), implies that G is topologically isomorphic to $H \times D$, where $D = G/H$ is discrete. Thus G is topologically isomorphic to $\mathbb{R}^a \times \mathbb{T}^b \times D$, as required. \square

The next corollary follows immediately.

A5.5.26 Corollary. Any connected topological group locally isomorphic to \mathbb{R}^n , $n \geq 1$, is topologically isomorphic to $\mathbb{R}^a \times \mathbb{T}^b$, where $a + b = n$.

A5.5.27 Remark. We conclude this section by noting that some of the results presented here can be extended from finite to infinite products of copies of \mathbb{R} . For example, it is known that any closed subgroup of a countable product $\prod_{i=1}^{\infty} R_i$ of isomorphic copies R_i of \mathbb{R} is topologically isomorphic to a countable product of isomorphic copies of \mathbb{R} and \mathbb{Z} . However, this result does not extend to uncountable products. For details of the countable products case, [Brown et al. \[60\]](#) and [Leptin \[258\]](#). The uncountable case is best considered in the context of pro-Lie groups, [Hofmann and Morris \[190\]](#).

Exercises A5.5

1. If $a, b \in \mathbb{R}$ show that the subgroup of \mathbb{R} generated by $\{a, b\}$ is closed if and only if a and b are rationally dependent.
2. Prove that any linear transformation of the vector space \mathbb{R}^n , $n \geq 1$, onto itself is a homeomorphism.
3. (i) Let $\{a_1, \dots, a_p\}$ be a linearly independent subset of \mathbb{R}^n , $n \geq 1$, and

$$b = \sum_{i=1}^p t_i a_i,$$
 $t_i \in \mathbb{R}$. Show that $\text{gp}\{a_1, \dots, a_p, b\}$ is discrete if and only if t_1, \dots, t_p are rational numbers.

(ii) Hence prove the following (diophantine approximation) result: Let $\theta_1, \dots, \theta_n$ be n real numbers. In order that for each $\varepsilon > 0$ there exist an integer q and n integers p_i , $i = 1, \dots, n$ such that

$$|q\theta_i - p_i| \leq \varepsilon, \quad i = 1, \dots, n$$

where the left hand side of at least one of these inequalities does not vanish, it is necessary and sufficient that at least one of the θ_i be irrational.

4. Prove [Theorem A5.5.13](#) using the results preceding the Theorem.
5. Prove [Corollary A5.5.17](#) using the results preceding the Corollary.
5. Prove [Corollary A5.5.20](#) using the results preceding the Corollary.
6. Prove [Proposition A5.5.23](#) using the results preceding the Proposition.
7. Prove that if a, b, n, m are integers with $a + b = n + m$ and D_1 and D_2 are discrete groups, then $\mathbb{R}^a \times \mathbb{T}^b \times D_1$ is locally isomorphic to $\mathbb{R}^n \times \mathbb{T}^m \times D_2$.
8. Show that if G and H are locally isomorphic topological groups then there exists a neighbourhood V' of e in G and U' of e in H and a homeomorphism f of V' onto U' such that if x, y and xy all belong to V' then $f(xy) = f(x)f(y)$ and if x', y' and $x'y'$ all belong to U' then $f^{-1}(x'y') = f^{-1}(x')f^{-1}(y')$.

9. (i) Verify that any topological group locally isomorphic to a Hausdorff topological group is Hausdorff.
- (ii) Verify that any connected topological group locally isomorphic to an abelian group is abelian.
- (iii) Deduce that any connected topological group locally isomorphic to \mathbb{R}^n , $n \geq 1$, is topologically isomorphic to $\mathbb{R}^a \times \mathbb{T}^b$, where $a + b = n$.
10. Prove [Proposition A5.5.24](#) using the results preceding the Proposition.
11. Let U be a neighbourhood of 0 in an abelian topological group G and V a neighbourhood of 0 in \mathbb{R}^n , $n \geq 1$. If there is a continuous map f of V onto U such that $x \in V$, $y \in V$ and $x + y \in V$ implies $f(x + y) = f(x) + f(y)$, show that f can be extended to a continuous homomorphism of \mathbb{R}^n onto the open subgroup of G generated by U .

A5.6 Uniform Spaces

We now say a few words about uniform spaces just enough for our purposes here. For further discussion, see Kelley [\[233\]](#) and Bourbaki [\[51\]](#).

We introduce some notation convenient for this discussion.

Let X be a set and $X \times X = X^2$ the product of X with itself. If V is a subset of X^2 then V^{-1} denotes the set $\{(y, x) : (x, y) \in V\} \subseteq X^2$. If U and V are subsets of X^2 then UV denotes the set of all pairs (x, z) , such that for some $y \in X$, $(x, y) \in U$ and $(y, z) \in V$. Putting $V = U$ defines U^2 . The set $\{(x, x) : x \in X\}$ is called the **diagonal**.

A5.6.1 Definitions. A **uniformity** on a set X is a non-empty set \mathcal{U} of subsets of $X \times X$ such that

- (a) Each member of \mathcal{U} contains the diagonal;
- (b) $U \in \mathcal{U} \implies U^{-1} \in \mathcal{U}$;
- (c) if $U \in \mathcal{U}$ then there is a $V \in \mathcal{U}$ such that $V^2 \subseteq U$;
- (d) if $U \in \mathcal{U}$ and $V \in \mathcal{U}$, then $U \cap V \in \mathcal{U}$;
- (e) if $U \in \mathcal{U}$ and $U \subseteq V \subseteq X^2$, then $V \in \mathcal{U}$.

The pair (X, \mathcal{U}) is called a **uniform space** and each member of \mathcal{U} is called an **entourage**.

A5.6.2 Examples. If \mathbb{R} is the set of real numbers, then the **usual uniformity on \mathbb{R}** is the set \mathcal{U} of all subsets of U of $\mathbb{R} \times \mathbb{R}$ such that $\{(x, y) : |x - y| < r\} \subseteq U$, for some positive real number r .

Indeed if (X, d) is any metric space then we can define a uniformity \mathcal{U} on X by putting \mathcal{U} equal to the collection of all subsets U of $X \times X$ such that $\{(x, y) : d(x, y) < r\} \subseteq U$, for some positive real number r .

Let (G, \mathcal{T}) be a topological group and for each neighbourhood U of e , let $U_L = \{(x, y) : x^{-1}y \in U\}$ and $U_R = \{(x, y) : xy^{-1} \in U\}$. Then the **left uniformity** \mathcal{L} on G consists of all sets $V \subseteq G \times G$ such that $U_L \subseteq V$, for some U . Similarly we define the **right uniformity**. The **two-sided uniformity** consists of all sets W such that $U_L \subseteq W$ or $U_R \subseteq W$, for some U .

A5.6.3 Remarks. Given any uniformity \mathcal{U} on a set X we can define a corresponding topology on X . For each $x \in X$, let $U_x = \{y \in X : (x, y) \in U\}$. Then as U runs over \mathcal{U} , the system U_x defines a base of neighbourhoods at x for a topology; that is, a subset T of X is open in the topology if and only if for each $x \in T$ there is a $U \in \mathcal{U}$ such that $U_x \subseteq T$.

It is easily verified that **if (G, \mathcal{T}) is a topological group then the topologies arising from the left uniformity, the right uniformity and the two-sided uniformity all agree with the given topology.**

A5.6.4 Definitions. Let (E, \mathcal{T}_E) and (F, \mathcal{T}_F) be topological spaces and \mathcal{M} any set of subsets M of E and $\{V_i : i \in I\}$, for some index set I , a base of open sets for the topology \mathcal{T}_F on F . Let $P(M, V_i) = \{f : f \in F^E \text{ and } f(M) \subseteq V_i\}$.

(F^E denotes the set of all functions $f : E \rightarrow F$.)

The family $\{P(M, V_i) : M \in \mathcal{M}, I \in I\}$, is a subbase for a topology on F^E .

[If F is a Hausdorff space and \mathcal{M} is a covering of E then it is easily verified that this topology is Hausdorff.]

Two important special cases of this topology are when

- (a) \mathcal{M} is the collection of all finite subsets of E – the topology is then the **p -topology** or the **topology of pointwise convergence**, and
- (b) \mathcal{M} is the collection of all compact subsets of E – the **k -topology** or the **compact-open topology**.

Since every finite set is compact, $p \subseteq k$. Therefore a subset of F^E which is k -compact is also p -compact, but the converse is false.

Observe that F^E with the p -topology is simply $\prod_{x \in E} F_x$, with the product topology, where each F_x is a homeomorphic copy of F .

We are interested in $C(E, F)$, the subset of F^E consisting of all continuous functions from E to F , and we shall want to find conditions which guarantee that a subset of $C(E, F)$ is k -compact.

A5.6.5 Definition. Let (E, \mathcal{T}_E) and (F, \mathcal{T}_F) be topological spaces and G a subset of F^E . A topology \mathcal{T} on G is said to be **jointly continuous** if the map θ from the product space $(G, \mathcal{T}) \times (E, \mathcal{T}_E)$ to (F, \mathcal{T}_F) , given by $\theta(g, x) = g(x)$, is continuous.

A5.6.6 Proposition. Each topology \mathcal{T} on $G \subseteq F^E$ which is jointly continuous is finer than the k -topology.

Proof. Let U be an open set in (F, \mathcal{T}_F) , (K, \mathcal{T}_K) a compact subspace of (E, \mathcal{T}_E) , and θ the map taking (g, x) to $g(x)$, $g \in G$ and $x \in E$. We want to show that for each $f \in P(K, U) = \{g : g \in G \text{ and } g(K) \subseteq U\}$ there is a set $W \in \mathcal{T}$ such that $f \in W \subseteq P(K, U)$.

As θ is jointly continuous, the set $V = (G \times K) \cap \theta^{-1}(U)$ is open in $(G, \mathcal{T}) \times (K, \mathcal{T}_K)$. If $f \in P(K, U)$, then $\{f\} \times K \subseteq V$ and since $\{f\} \times K$ is compact, there is a $W \in \tau$ such that $f \in W$ and $W \times K \subseteq \theta^{-1}(U)$. Hence $W \subseteq P(K, U)$ as required. \square

A5.6.7 Proposition. Let (E, \mathcal{T}_E) and (F, \mathcal{T}_F) be topological spaces and $G \subseteq C(E, F)$. Then G is k -compact, that is compact in the k topology, if

- (a) G is k -closed in $C(E, F)$,
- (b) the closure of the set $\{g(x) : g \in G\}$ is compact in (F, \mathcal{T}_F) , for each $x \in E$,
and
- (c) the p -topology for the p -closure of G in F^E is jointly continuous.

Proof. Let \overline{G} be the p -closure in F^E of G . By condition (b), $\prod_{x \in E} \overline{\{g(x) : g \in G\}}$ is a p -compact set, and since \overline{G} is a p -closed subset of this set, \overline{G} is p -compact.

By condition (c), the p -topology on \overline{G} is jointly continuous – so $\overline{G} \subseteq C(E, F)$. Also by [Proposition A5.6.6](#), the p -topology on \overline{G} is finer than the k -topology and hence they coincide. Thus \overline{G} is k -compact. As G is k -closed in $C(E, F)$ and \overline{G} is k -compact and a subset of $C(E, F)$, we have that G is k -compact. \square

A5.6.8 Definitions. Let E be a topological space and F a uniform space. A subset G of $C(E, F)$ is said to be **equicontinuous at the point** $x \in E$ if for each U in the uniformity \mathcal{U} of F , there exists a neighbourhood V of x such that $(g(y), g(x)) \in U$, for all $y \in V$ and $g \in G$. The family G is said to be **equicontinuous** if it is equicontinuous at every $x \in E$.

A5.6.9 Proposition. Let G be a subset of $C(E, F)$ which is equicontinuous at $x \in E$. Then the p -closure, \overline{G} , in F^E of G is also equicontinuous at x .

Proof. Exercise.

A5.6.10 Proposition. Let G be an equicontinuous subset of $C(E, F)$. Then the p -topology on G is jointly continuous.

Proof. Exercise.

By combining Propositions [A5.6.7](#), [A5.6.9](#) and [A5.6.10](#) we obtain the following:

A5.6.11 Theorem. (Ascoli's Theorem) Let (E, \mathcal{T}_E) be a topological space and F a uniform space. A subset G of $C(E, F)$ is k -compact if

- (a) G is k -closed in $C(E, F)$,
- (b) the closure of the set $\{g(x) : g \in G\}$ is compact, for each $x \in E$, and
- (c) G is equicontinuous. □

A5.6.12 Remark. If E is a locally compact Hausdorff space and F is a Hausdorff uniform space then the converse of [Theorem 5.6.11](#) is valid; that is, any k -compact subset of G of $C(E, F)$ satisfies conditions (a), (b) and (c). (See Kelley [233])

Exercises A5.6

1. Let (X, \mathcal{U}) be any uniform space and (X, \mathcal{T}) the associated topological space. Show that (X, \mathcal{T}) is a regular space.
2. If (G, \mathcal{T}) is a topological group show that the topologies associated with the left uniformity on G , the right uniformity on G , and the two-sided uniformity on G coincide with \mathcal{T} .
3. (i) Let G be a topological group and $\{U_n : n = 1, 2, \dots\}$ a base for the left uniformity

on G such that

$$(a) \bigcap_{n=1}^{\infty} U_n = \text{diagonal of } G \times G,$$

$$(b) U_{n+1}U_{n+1}U_{n+1} \subseteq U_n, \text{ and}$$

$$(c) U_n = U_n^{-1}, \text{ for each } n.$$

Show that there exists a metric d on G such that

$$U_n \subseteq \{(x, y) : d(x, y) < 2^{-n}\} \subseteq U_{n-1}, \text{ for each } n > 1.$$

[Hint: Define a real-valued function f on $G \times G$ by letting $f(x, y) = 2^{-n}$ if $(x, y) \in U_{n-1} \setminus U_n$ and $f(x, y) = 0$ if (x, y) belongs to each U_n . The desired metric d is constructed from its "first approximation", f , by a chaining argument. For each x and y in G let $d(x, y)$ be the infimum of $\left\{ \sum_{i=0}^n f(x_i, x_{i+1}) \right\}$ over all finite sequences x_0, x_1, \dots, x_{n+1} such that $x = x_0$ and $y = x_{n+1}$.]

- (ii) Prove that **a Hausdorff topological group is metrizable if and only if it satisfies the first axiom of countability at the identity; that is, there is a countable base of neighbourhoods at the identity.**

4. Let E be a topological space, F a uniform space and G a subset of $C(E, F)$. Show that

- (i) if G is equicontinuous at $x \in E$, then the p -closure in F^E of G is also equicontinuous at x ; and
- (ii) if G is an equicontinuous subset of $C(E, F)$, then the p -topology on G is jointly continuous.

A5.7 Dual Groups

We are now ready to begin our study of duality.

A5.7.1 Definitions. If G is an abelian topological group then a continuous homomorphism $\gamma : G \rightarrow \mathbb{T}$ is said to be a **character**. The collection of all characters is called the **character group** or **dual group** of G , and is denoted by G^* or Γ .

Observe that G^* is an abelian group if for each γ_1 and γ_2 in G^* we define

$$(\gamma_1 + \gamma_2)(g) = \gamma_1(g) + \gamma_2(g), \text{ for all } g \in G.$$

Instead of writing $\gamma(g)$, $\gamma \in \Gamma$ and $g \in G$ we shall generally write (g, γ) .

A5.7.2 Example. Consider the group \mathbb{Z} . Each character γ of \mathbb{Z} is determined by $\gamma(1)$, as $\gamma(n) = n\gamma(1)$, for each $n \in \mathbb{Z}$. Of course $\gamma(1)$ can be any element of \mathbb{T} . For each $a \in \mathbb{T}$, let γ_a denote the character γ of \mathbb{Z} with $\gamma(1) = a$. Then the mapping $a \rightarrow \gamma_a$ is clearly an algebraic isomorphism of \mathbb{T} onto the character group of \mathbb{Z} . So the dual group \mathbb{Z}^* of \mathbb{Z} is algebraically isomorphic to \mathbb{T} . \square

A5.7.3 Examples.

- (i) Consider the group \mathbb{T} . We claim that every character γ of \mathbb{T} can be expressed in the form $\gamma(x) = mx$, where m is an integer characterizing the homomorphism γ .

To see this let K denote the kernel of γ . Then by [Corollary A5.5.6](#), $K = \mathbb{T}$ or K is a finite cyclic group. If $K = \mathbb{T}$, then γ is the trivial character and $\gamma(x) = 0.x$, $x \in \mathbb{T}$. If K is a finite cyclic group of order r then, by [Corollary A5.5.5](#), \mathbb{T}/K is topologically isomorphic to \mathbb{T} . Indeed, if p is the canonical map of \mathbb{T} onto \mathbb{T}/K then the topological isomorphism $\theta : \mathbb{T}/K \rightarrow \mathbb{T}$ is such that $\theta p(x) = rx$. Let α be the continuous one-one homomorphism of \mathbb{T} into \mathbb{T} induced by γ .

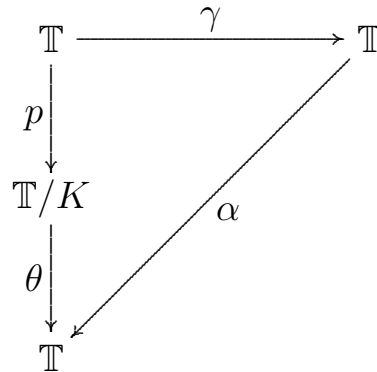

- (ii) Consider the group \mathbb{R} . We claim that every character γ of \mathbb{R} can be expressed in the form $\gamma(x) = \exp(2\pi idx)$, $x \in \mathbb{R}$, where d is a fixed real number defining $\gamma : \gamma = \gamma_d$. Further, we have $\gamma_a + \gamma_b = \gamma_{a+b}$. Thus the dual group of \mathbb{R} is algebraically isomorphic to \mathbb{R} itself, under the isomorphism $d \rightarrow \gamma_d$.

To prove the claim, let K denote the kernel of γ . If $K = \mathbb{R}$ then $\gamma = \gamma_0$. If $K \neq \mathbb{R}$ then [Proposition A5.5.2](#) says that K is isomorphic to \mathbb{Z} . Further by [Corollary A5.5.5](#) the quotient group \mathbb{R}/K is topologically isomorphic to \mathbb{T} . As in (i) above there are only two possibilities for the induced algebraic isomorphism $\mathbb{R}/K \rightarrow \mathbb{T}$; these give rise to the cases $\gamma = \gamma_{1/a}$ and $\gamma = \gamma_{(-1/a)}$, where a is the least element of K . So every γ is of the form γ_d for some $d \in \mathbb{R}$, and hence \mathbb{R} is algebraically isomorphic to its dual group.

[Exercises A5.7 #1](#) implies that $\alpha(x) = x$, for all $x \in \mathbb{T}$, or $\alpha(x) = -x$, for all $x \in \mathbb{T}$. So $\gamma(x) = rx$ or $-\gamma(x) = rx$, for each $x \in \mathbb{T}$.

Hence each character γ of \mathbb{T} is of the form $\gamma = \gamma_m$ for some $m \in \mathbb{Z}$, where $\gamma_m(x) = mx$ for all $x \in \mathbb{T}$. Of course $\gamma_m + \gamma_n = \gamma_{m+n}$. Thus the dual group \mathbb{T}^* of \mathbb{T} is algebraically isomorphic to \mathbb{Z} , with the isomorphism being $m \rightarrow \gamma_m$. \square

We now topologize G^* .

A5.7.4 Remark. Note that G^* is a p -closed subset of $C(G, \mathbb{T})$. \square

A5.7.5 Proposition. Let G be any abelian topological group. Then G^* endowed with the p -topology or the k -topology is a Hausdorff abelian topological group.

Proof. Exercise.

A5.7.6 Theorem. If G is any LCA-group then G^* , endowed with the k -topology, is an LCA-group.

Proof. To show that G^* , with the k -topology, is locally compact, let U be any compact neighbourhood of 0 in G and $V_a = \{t : t = \exp(2\pi ix) \in \mathbb{T} \text{ and } 1 > x > 1 - a \text{ or } a > x \geq 0\}$, where a is a positive real number less than $\frac{1}{4}$. Then V_a is an open neighbourhood of 0 in \mathbb{T} .

Let $N_a = P(U, V_a) = \{\gamma \in G^* : (g, \gamma) \in V_a, \text{ for each } g \in U\}$. By the definition of the k -topology, N_a is a neighbourhood of 0 in G^* . we shall show that the k -closure of N_a , $cl_k(N_a)$, is k -compact. To do this we use [Ascoli's Theorem A5.6.11](#).

Firstly, we show that N_a is equicontinuous. Let $\varepsilon > 0$ be given. We wish to show that there exists a neighbourhood U_1 of 0 in G such that for all $\gamma \in N_a$ and g, h , and $g - h$ in U_1 , $(g - h, \gamma) = (g, \gamma) - (h, \gamma) \in V_\varepsilon$, where

$$V_\varepsilon = \{t : t = \exp(2\pi ix) \in \mathbb{T} \text{ and } 1 > x > 1 - \varepsilon \text{ or } \varepsilon > x \geq 0\}.$$

Suppose that there is no such U_1 . Without loss of generality assume $\varepsilon < \frac{1}{4}$ and let n be a positive integer such that $\frac{1}{2} > n\varepsilon > a$. Further, let W be a neighbourhood of 0 in G such that

$$\sum_{i=1}^n W_i \subseteq U, \text{ where each } W_i = W. \quad (1)$$

By assumption, then, for some g and h in W with $g - h \in W$ and some $\gamma \in N_a$, $(g - h, \gamma) \notin V_\varepsilon$. So without loss of generality $(g - h, \gamma) = \exp(2\pi ix)$ with $a > x \geq \varepsilon$. Let j be a positive integer less than or equal to n such that $\frac{1}{2} > jx > a$. So $(j(g - h), \gamma) \notin V_a$. But as jpg , jhh and $j(g - h)$ all belong to U , by (1), $(j(g - h), \gamma) \in V_a$, which is a contradiction. Hence N_a is equicontinuous.

By [Proposition A5.6.9](#) the p -closure of N_a is equicontinuous. As any subset of an equicontinuous set is equicontinuous, and $cl_k(N_a)$ is a subset of the p -closure of N_a , we have that $cl_k(N_a)$ is equicontinuous.

As \mathbb{T} is compact, condition (b) of [Ascoli's Theorem A5.6.11](#) is also satisfied and hence $cl_k(N_a)$ is a compact neighbourhood of 0. So G^* with the k -topology is locally compact. □

As a corollary to the proof of [Theorem A5.7.6](#) we have

A5.7.7 Corollary. Let G be any LCA-group, Γ its dual group endowed with the k -topology, K a compact neighbourhood of 0 in G and for some positive real number $a < \frac{1}{4}$, $V_a = \{t : t = \exp(2\pi ix) \in T \text{ with } 1 > x > 1 - a \text{ or } a > x \geq 0\}$. Then $\overline{P(K, V_a)}$ is a compact neighbourhood of 0 in Γ . \square

A5.7.8 Notation. From now on G^* and Γ will denote the dual group of G with the k -topology.

A5.7.9 Theorem. Let G be an LCA-group and Γ its dual group. If G is compact, then Γ is discrete. If G is discrete, then Γ is compact.

Proof. Let G be compact and V_a be as in [Corollary A5.7.7](#). Then $P(G, V_a)$ is a neighbourhood of 0 in Γ . As V_a contains no subgroup other than $\{0\}$, we must have $P(G, V_a) = \{0\}$. So Γ has the discrete topology.

Let G be discrete. Then by [Corollary A5.7.7](#), $\overline{P(\{0\}, V_a)}$ is a compact subset of Γ . But $\overline{P(\{0\}, V_a)}$ clearly equals Γ , and hence Γ is compact. \square

A5.7.10 Corollary. The dual group \mathbb{T}^* of \mathbb{T} is topologically isomorphic to \mathbb{Z} . \square

Exercises A5.7

1. Show that if γ is a continuous one-to-one homomorphism of \mathbb{T} into itself then either $\gamma(x) = x$, for all $x \in \mathbb{T}$ or $\gamma(x) = -x$, for all $x \in \mathbb{T}$.

[Hint: Firstly show that γ must be onto. Next, observe that \mathbb{T} has only one element of order 2.]

2. Show that if G is any abelian topological group, then G^* endowed with the p -topology or the k -topology is a Hausdorff topological group.

[Hint: Let $\gamma_1 - \gamma_2 \in P(K, U)$. Let W be an open symmetric neighbourhood of 0 in \mathbb{T} such that $2W + (\gamma_1 - \gamma_2)(K) \subseteq U$. Observe that

$$[\gamma_1 + P(K, W)] - [\gamma_2 + P(K, W)] \subseteq P(K, U).]$$

3. Show that the dual group of \mathbb{Z} is topologically isomorphic to \mathbb{T} .
4. Show that \mathbb{R} is topologically isomorphic to its dual group.
5. Find the dual groups of the discrete finite cyclic groups.
6. Let G be any abelian topological group and G^* its dual group. Show that the family of all sets $P(K, V_\varepsilon)$, as K ranges over all compact subsets of G containing O and ε ranges over all positive numbers less than one, is a base of open neighbourhoods of O for the k -topology on G^* .

A5.8 Pontryagin–van Kampen Duality Theorem: Introduction

We begin with a statement of the duality theorem.

Theorem. [Pontryagin-van Kampen Duality Theorem] Let G be an LCA-group and Γ its dual group. For fixed $g \in G$, let $g' : \Gamma \rightarrow \mathbb{T}$ be the function given by $g'(\gamma) = \gamma(g)$, for all $\gamma \in \Gamma$. If $\alpha : G \rightarrow \Gamma^*$ is the mapping given by $\alpha(g) = g'$, then α is a topological group isomorphism of G onto Γ^* .

A5.8.1 Remarks.

- (i) Roughly speaking this says that every LCA-group is the dual group of its dual group.
- (ii) This theorem says that **every piece of information about an LCA-group is contained in some piece of information about its dual group.** In particular all information about a compact Hausdorff abelian group is contained in information about its dual group – a discrete abelian group. So any compact Hausdorff abelian group can be completely described by the purely algebraic properties of its dual group; for example, if G is a compact Hausdorff abelian group then we shall see that
 - (a) G is metrizable if and only if Γ is countable.
 - (b) G is connected if and only if Γ is torsion-free. □

A5.8.2 Lemma. In the notation of the above Theorem, α is a continuous homomorphism of G into Γ^* .

Proof. Firstly we have to show that $\alpha(g) \in \Gamma^*$; that is, $\alpha(g) = g'$ is a continuous homomorphism of Γ into \mathbb{T} .

As $\alpha(g)(\gamma_1 + \gamma_2) = (\gamma_1 + \gamma_2)(g) = \gamma_1(g) + \gamma_2(g) = \alpha(g)(\gamma_1) + \alpha(g)(\gamma_2)$, for each γ_1 and γ_2 in Γ , $\alpha(g) : \Gamma \rightarrow \mathbb{T}$ is a homomorphism.

To see that $\alpha(g)$ is continuous, it suffices to note that $\alpha(g)(\gamma) \in V_\varepsilon$ whenever $\gamma \in P(\{g\}, V_\varepsilon)$, where V_ε is an ε -neighbourhood of 0 in \mathbb{T} as in [Theorem A5.7.6](#). So α is a map of G into Γ^* .

That α is a homomorphism follows by observing

$$\begin{aligned} \alpha(g_1 + g_2)(\gamma) &= \gamma(g_1 + g_2) = \gamma(g_1) + \gamma(g_2) = \alpha(g_1)(\gamma) + \alpha(g_2)(\gamma), \text{ for all } \gamma \in \Gamma, \\ &\implies \alpha(g_1 + g_2) = \alpha(g_1) + \alpha(g_2), \text{ for all } g_1, g_2 \in G. \end{aligned}$$

To show that α is continuous, it suffices to verify continuity at $0 \in G$. Let W be any neighbourhood of 0 in Γ^* . Without loss of generality we can assume $W = P(K, V_\varepsilon)$, for some compact subset K of Γ . We have to find a neighbourhood of 0 in G which maps into W .

Let U be any open neighbourhood of 0 in G such that \overline{U} is compact and consider the neighbourhood $P(\overline{U}, V_{\varepsilon/2})$ of 0 in Γ . The collection $\{\gamma + P(\overline{U}, V_{\varepsilon/2}) : \gamma \in \Gamma\}$ covers the compact set K and so there exist $\gamma_1, \dots, \gamma_m$ in Γ such that

$$K \subseteq [\gamma_1 + P(\overline{U}, V_{\varepsilon/2})] \cup \dots \cup [\gamma_m + P(\overline{U}, V_{\varepsilon/2})].$$

Let U_1 be a neighbourhood of 0 in G such that $U_1 \subseteq U$ and $\gamma_i(g) \in V_{\varepsilon/2}$, for all $g \in U_1$ and $i = 1, \dots, m$. (This is possible since the γ_i are continuous.) We claim that U_1 is the required neighbourhood. To see this let $g \in U_1$ and consider $\alpha(g)(\gamma)$, where $\gamma \in K$. Then $\gamma \in \gamma_i + P(\overline{U}, V_{\varepsilon/2})$, for some $i \in \{1, \dots, m\}$. So $\gamma - \gamma_i \in P(\overline{U}, V_{\varepsilon/2})$. Thus $(\gamma - \gamma_i)(g) \in V_{\varepsilon/2}$ for $g \in U_1 \subseteq U$. As $\gamma_i(g) \in V_{\varepsilon/2}$, this implies that $\gamma(g) \in V_{\varepsilon/2} + V_{\varepsilon/2} \subseteq V_\varepsilon$. So $\alpha(g)(\gamma) \in V_\varepsilon$, as required. \square

The duality theorem will be proved for compact groups and discrete groups first, and then it will be extended to all LCA-groups.

There are a number of proofs of the duality theorem in the literature. The proof presented in this Appendix is from Morris [293]. An elegant proof appears in Rudin [353]. Hewitt and Ross [180] present the more classical approach of first deriving the structure theory of LCA-groups and then using it in the proof of duality. A proof using category theory is given in Roeder [343]. Other references include Weil [421], Cartan and Godement [71], Raikov [335], Naimark [306], Dikranjan et al. [108] and of course, Pontryagin [330].

Exercises A5.8

1. Show that \mathbb{Z} satisfies the [Pontryagin-van Kampen Duality Theorem](#).
(Note. This requires more than just showing that \mathbb{Z}^{**} is topologically isomorphic to \mathbb{Z} . You must prove that the map α in the duality theorem is a topological group isomorphism.)
[Hint. See [Example A5.7.2](#) and [Example A5.7.3](#).]
2. Show that \mathbb{T} satisfies the [Pontryagin-van Kampen Duality Theorem](#).
[Hint. Firstly show that α is 1-1 and onto. Then use the [Open Mapping Theorem A5.4.4](#).]
3. Prove that every discrete finite cyclic group satisfies the [Pontryagin-van Kampen Duality Theorem](#).
4. Prove that the topological group \mathbb{R} satisfies the [Pontryagin-van Kampen Duality Theorem](#).

A5.9 Dual Groups of Subgroups, Quotients, and Finite Products

Now we make some observations which are needed in the proof of the duality theorem, but which are also of interest in themselves.

A5.9.1 Theorem. If G_1, \dots, G_n are LCA-groups with dual groups $\Gamma_1, \dots, \Gamma_n$, respectively, then $\Gamma = \Gamma_1 \times \Gamma_2 \times \cdots \times \Gamma_n$ is the dual group of $G_1 \times G_2 \times \cdots \times G_n$.

Proof. It suffices to prove this for the case $n = 2$, and finite products can then be easily deduced by mathematical induction.

If $g = g_1 + g_2$ is the unique representation of $g \in G$ as a sum of elements of G_1 and G_2 , then the pair $\gamma_1 \in \Gamma_1$ and $\gamma_2 \in \Gamma_2$ determine a character $\gamma \in \Gamma$ by the formula

$$(g, \gamma) = (g_1, \gamma_1) + (g_2, \gamma_2) \quad (1)$$

Since every $\gamma \in \Gamma$ is completely determined by its action on the subgroups G_1 and G_2 , equation (1) shows that Γ is algebraically the direct sum of Γ_1 and Γ_2 .

To see that Γ has the product topology $\Gamma_1 \times \Gamma_2$ simply note that

- (a) $P(K, V_\varepsilon) \supseteq P(K_1, V_{\varepsilon/2}) + P(K_2, V_{\varepsilon/2})$, where K is any compact subset of $G = G_1 \times G_2$, $K_1 = p_1(K)$, $K_2 = p_2(K)$ and p_1 and p_2 are the projections of G onto G_1 and G_2 , respectively, and
- (b) if K_1 is a compact subset of G_1 containing 0 and K_2 is a compact subset of G_2 containing 0, then $P(K_1 \times K_2, V_\varepsilon) \subseteq P(K_1, V_\varepsilon) + P(K_2, V_\varepsilon)$. (See [Exercises A5.7 #6.](#))

□

A5.9.2 Corollary. For each $n \geq 1$, \mathbb{R}^n is topologically isomorphic to its dual group. □

A5.9.3 Corollary. For each $n \geq 1$, the topological groups \mathbb{T}^n and \mathbb{Z}^n are dual groups of each other. \square

A5.9.4 Corollary. If G_1, \dots, G_n are LCA-groups which satisfy the [Pontryagin-van Kampen Duality Theorem](#), then $G_1 \times G_2 \times \dots \times G_n$ satisfies the [Pontryagin-van Kampen Duality Theorem](#). Hence $\mathbb{R}^a \times \mathbb{T}^b \times G$ satisfies the [Pontryagin-van Kampen Duality Theorem](#), where G is a discrete finitely generated abelian group, and a and b are non-negative integers.

Proof. Exercise.

[Theorem A5.9.1](#) shows that the dual group of a finite product is the product of the dual groups. We shall see, in due course, that the dual of a closed subgroup is a quotient group, and the dual of a quotient group is a closed subgroup. As a first step towards this we have [Proposition A5.9.5](#).

A5.9.5 Proposition. Let f be a continuous homomorphism of an LCA-group A into an LCA-group B . Let a map $f^* : B^* \rightarrow A^*$ be defined by putting $f^*(\gamma)(a) = \gamma f(a)$, for each $\gamma \in B^*$ and $a \in A$. Then f^* is a continuous homomorphism of B^* into A^* . If f is onto, then f^* is one-one. If f is both an open mapping and one-one, then f^* is onto.

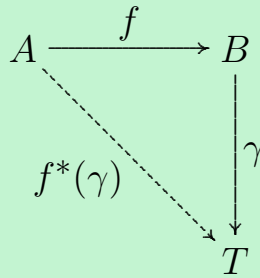

Proof. The verification that f^* is a homomorphism of B^* into A^* is routine. To see that f^* is continuous, let $P(K, U)$ be a subbasic open set in A^* , where U is an open subset of \mathbb{T} and K is a compact subset of A . The continuity of f^* follows from the fact that $(f^*)^{-1}(P(K, U)) = P(f(K), U)$ is an open subset of B^* .

Assume f is onto and suppose that $f^*(\gamma_1) = f^*(\gamma_2)$ where γ_1 and γ_2 are in B^* . Then $f^*(\gamma_1)(a) = f^*(\gamma_2)(a)$, for all $a \in A$; that is, $\gamma_1 f(a) = \gamma_2 f(a)$, for all $a \in A$. As f is onto this says that $\gamma_1(b) = \gamma_2(b)$, for all $b \in B$. Hence $\gamma_1 = \gamma_2$ and f^* is one-one.

Assume that f is both an open mapping and one-one. Let $\delta \in A^*$. As f is one-one, [Proposition A5.3.6](#) tells us that there is a (not necessarily continuous) homomorphism $\gamma : B \rightarrow \mathbb{T}$ such that $\delta = \gamma f$. As δ is continuous and f is an open mapping, γ is indeed continuous; that is, $\gamma \in B^*$. As $f^*(\gamma) = \delta$, we have that f^* is onto. \square

A5.9.6 Corollary. If B is a quotient group of A , where A and B are either both compact Hausdorff abelian groups or both discrete abelian groups, then B^* is topologically isomorphic to a subgroup of A^* .

Proof. Exercise.

A5.9.7 Corollary. If A is a subgroup of B , where A and B are discrete abelian groups, then A^* is a quotient group of B^* .

Proof. Exercise.

A5.9.8 Remark. As noted earlier we shall see in due course that [Corollary A5.9.6](#) and [Corollary A5.9.7](#) remain true if the hypotheses "compact Hausdorff" and "discrete" are replaced by "locally compact Hausdorff". We also mention that the analogous results for duality in Banach spaces appears in [Exercises 10.3 #33\(xvi\)](#).

The next lemma indicates that, before proving the [Pontryagin-van Kampen Duality Theorem](#), we shall have to see that LCA-groups have enough characters to separate points.

A5.9.9 Lemma. In the notation of the [Pontryagin-van Kampen Duality Theorem](#), the map α is one-one if and only if G has enough characters to separate points; that is, for each g and h in G , with $g \neq h$, there is a $\gamma \in \Gamma$ such that $\gamma(g) \neq \gamma(h)$.

Proof. Assume that α is one-one. Suppose that there exist g and h in G , with $g \neq h$, such that $\gamma(g) = \gamma(h)$ for all $\gamma \in \Gamma$. Then $\alpha(g)(\gamma) = \alpha(h)(\gamma)$, for all $\gamma \in \Gamma$. So $\alpha(g) = \alpha(h)$, which implies that $g = h$, a contradiction. Hence G has enough characters to separate points.

Assume now that G has enough characters to separate points. Let g and h be in G , with $g \neq h$. Then there is a $\gamma \in \Gamma$ such that $\gamma(g) \neq \gamma(h)$. So $\alpha(g)(\gamma) \neq \alpha(h)(\gamma)$, which implies that $\alpha(g) \neq \alpha(h)$. So α is one-one. \square

The final proposition in this section should remind some readers of the [Stone-Weierstrass Theorem](#).

A5.9.10 Proposition. Let G be an LCA-group and Γ its dual group. Let G satisfy the [Pontryagin-van Kampen Duality Theorem](#) and also have the property that every nontrivial Hausdorff quotient group Γ/B of Γ has a nontrivial character. If A is a subgroup of Γ which separates points of G , then A is dense in Γ .

Proof. Suppose A is not dense in Γ . If B is the closure of A in Γ then Γ/B is a nontrivial LCA-group. So there exists a nontrivial continuous homomorphism $\phi : \Gamma/B \rightarrow \mathbb{T}$.

Let f be the canonical homomorphism $\Gamma \rightarrow \Gamma/B$. Then ϕf is a continuous homomorphism $\Gamma \rightarrow \mathbb{T}$. Furthermore, $\phi f(\Gamma) \neq 0$ but $\phi f(B) = 0$.

As G satisfies the [Pontryagin-van Kampen Duality Theorem](#), there is a $g \in G$ such that $\phi f(\gamma) = \gamma(g)$, for all $\gamma \in \Gamma$. So $\gamma(g) = 0$ for all γ in A . But since A separates points in G , this implies $g = 0$. So $\phi f(\Gamma) = 0$, which is a contradiction. Hence A is dense in Γ . □

Of course the second sentence in the statement of [Proposition A5.9.10](#) will, in due course, be seen to be redundant.

Exercises A5.9

1. (i) Show that if G_1, \dots, G_n are LCA-groups which satisfy the [Pontryagin-van Kampen Duality Theorem](#), then $G_1 \times G_2 \times \dots \times G_n$ satisfies the [Pontryagin-van Kampen Duality Theorem](#).
 - (ii) Deduce that every discrete finitely generated abelian group satisfies the [Pontryagin-van Kampen Duality Theorem](#).
[Hint: Use the fact that every finitely generated abelian group is a direct product of a finite number of cyclic groups.]
 - (iii) Hence show that $\mathbb{R}^a \times \mathbb{T}^b \times G$ satisfies the [Pontryagin-van Kampen Duality Theorem](#), where G is a discrete finitely generated abelian group, and a and b are non-negative integers.
2. Show that if B is a quotient group of A , where A and B are either both compact Hausdorff abelian groups or both discrete abelian groups, then B^* is topologically isomorphic to a subgroup of A^* .
 3. Show that if A is a subgroup of B , where A and B are discrete abelian groups, then A^* is a quotient group of B^* .
 4. Show that if G is any LCA-group and Γ is its dual group, then Γ has enough characters to separate points.

A5.10 Peter-Weyl Theorem

In [Lemma A5.9.9](#) we saw that a necessary condition for a topological group to satisfy duality is that it have enough characters to separate points. That discrete abelian groups have this property has been indicated already in [Corollary A5.3.7](#). For compact groups we use a result from the representation theory of topological groups. [For a brief outline of this theory, see Higgins [\[182\]](#). Fuller discussions appear in Adams [\[5\]](#), Hewitt and Ross [\[180\]](#), Pontryagin [\[330\]](#) and Hofmann [\[192\]](#).]

The following theorem is named after Hermann Weyl (1885–1955) and his student Fritz Peter (1899–1949). Weyl and Peter proved this in Weyl and Peter [\[422\]](#) in 1927 for compact Lie groups and by the Dutch mathematician Egbert Rudolf van Kampen (1908–1942) extended it to all compact groups in van Kampen [\[397\]](#) in 1935 using the 1934 work, von Neumann [\[411\]](#), of the Hungarian-American mathematician John von Neumann (1903–1957) on almost periodic functions.

A5.10.1 Theorem. (Peter-Weyl Theorem) Let G be a compact Hausdorff group. Then G has sufficiently many irreducible continuous representations by unitary matrices. In other words, for each $g \in G$, $g \neq e$, there is a continuous homomorphism ϕ of G into the unitary group $U(n)$, for some n , such that $\phi(g) \neq e$.

If G is abelian then, without loss of generality, it can be assumed that $n = 1$. As $U(1) = \mathbb{T}$ we obtain the following corollary, which is the result which we shall use in proving duality for compact abelian groups.

A5.10.2 Corollary. Every compact Hausdorff abelian topological group has enough characters to separate points.

Corollary A5.10.2 was first proved by John von Neumann for compact metrizable abelian groups. A derivation of Corollary A5.10.2 from von Neumann's result is outlined in [Exercises A5.10 #2](#) and [#3](#).

A5.10.3 Corollary. Let G be any compact Hausdorff abelian group. Then G is topologically isomorphic to a closed subgroup of the product $\prod_{i \in I} T_i$, where each T_i is topologically isomorphic to \mathbb{T} , and I is some index set.

Proof. Exercise.

A5.10.4 Corollary. Let G be a compact Hausdorff abelian group. Then every neighbourhood U of 0 contains a closed subgroup H such that G/H is topologically isomorphic to $\mathbb{T}^n \times D$, for some finite discrete group D and $n \geq 0$.

Proof. Exercise.

Exercises A5.10

1. Using [Exercises A5.3 #4\(i\)](#), show that every compact totally disconnected abelian topological group has enough characters to separate points.
2. Show that every compactly generated locally compact Hausdorff group G can be approximated by metrizable groups in the following sense: For each neighbourhood U of e , there exists a compact normal subgroup H of G such that $H \subseteq U$ and G/H is metrizable.

[Hint: Let V_1, V_2, V_3, \dots be a sequence of symmetric compact neighbourhoods of e such that (i) $V_1 \subseteq U$, (ii) $V_{n+1}^2 \subseteq V_n$, for $n \geq 1$, and (iii) $g^{-1}V_n g \subseteq V_{n-1}$, for $n \geq 2$ and $g \in K$, where K is a compact set which generates G . Put $H = \bigcap_{n=1}^{\infty} V_n$ and use [Exercises A5.6 #3](#).]

3. Using Exercise 2 above, deduce statement B from statement A.
 - (A) Every compact metrizable abelian group has enough characters to separate points.

(B) Every compact Hausdorff abelian group has enough characters to separate points.

4. (i) Show that every compact Hausdorff abelian group G is topologically isomorphic to a subgroup of a product $\prod_{i \in I} T_i$ of copies of \mathbb{T} .

[Hint: See the proof of [Theorem A5.3.9](#).]

- (ii) If G is also metrizable show that the index set I can be chosen to be a countable set.

[Hint: Use [Exercises A5.6 #3\(ii\)](#).]

- (iii) Using (i) show that if G is any compact Hausdorff abelian group, then every neighbourhood U of 0 contains a closed subgroup H such that G/H is topologically isomorphic to $\mathbb{T}^n \times D$, for some finite discrete group D and $n \geq 0$.

[Hint: Reread [Remark A5.3.1](#). Use [Corollary A5.5.20](#).]

5. Show that every compact Hausdorff group is topologically isomorphic to a subgroup of a product of copies of U , where $U = \prod_{n=1}^{\infty} U(n)$.

A5.11 The Duality Theorem for Compact Groups and Discrete Groups

The next proposition provides the last piece of information we need in order to prove the [Pontryagin-van Kampen Duality Theorem](#) for compact groups and discrete groups. (This proposition should be compared with [Proposition A5.9.10](#).)

A5.11.1 Proposition. Let G be a discrete abelian group and Γ its dual group. If A is a subgroup of Γ which separates points of G , then A is dense in Γ .

Proof. Noting how the topology on Γ is defined, it suffices to show that each non-empty sub-basic open set $P(K, U)$, where K is a compact subset of G and U is an open subset of \mathbb{T} , intersects A nontrivially.

As G is discrete, K is finite. Let H be the subgroup of G generated by K and $f^* : \Gamma \rightarrow H^*$ the map obtained by restricting the characters of G to H . According to [Proposition A5.9.5](#) and [Corollary A5.9.7](#), f^* is an open continuous homomorphism of Γ onto H^* . As A separates points of G , $f^*(A)$ separates points of H . Observing that [Corollary 5.9.4](#) says that H satisfies the [Pontryagin-van Kampen Duality Theorem](#), [Proposition A5.9.10](#) then implies that $f^*(A)$ is dense in H^* . So $f^*(P(K, U)) \cap f^*(A) \neq \emptyset$. In other words there is a $\gamma \in A$ such that, when restricted to H , γ maps K into U . Of course this says that $\gamma \in P(K, U) \cap A$. \square

A5.11.2 Theorem. (Pontryagin-van Kampen Duality Theorem for Compact Groups) Let G be a compact Hausdorff abelian group and Γ its dual group. Then the canonical map α of G into Γ^* is a topological group isomorphism of G onto Γ^* .

Proof. By [Lemma A5.8.2](#), [Lemma A5.9.9](#) and [Theorem A5.10.1](#), α is a continuous one-one homomorphism of G into Γ^* . Clearly $\alpha(G)$ separates points of Γ . As Γ is discrete, [Proposition A5.11.1](#) then implies that $\alpha(G)$ is dense in Γ^* . However, $\alpha(G)$ is compact and hence closed in Γ^* . Thus $\alpha(G) = \Gamma^*$; that is, the map α is onto. Finally, the [Open Mapping Theorem for Locally Compact Groups A5.4.4](#) tells us that α is also an open map. \square

A5.11.3 Corollary. Let G be a compact Hausdorff abelian group and Γ its dual group. If A is a subgroup of Γ which separates points of G , then $A = \Gamma$.

Proof. This is an immediate consequence of [Theorem A5.11.2](#), [Proposition A 5.9.10](#), [Corollary A5.3.7](#), and [Corollary A5.7.7](#). \square

A5.11.4 Corollary. Let G be an LCA-group with enough characters to separate points and K a compact subgroup of G . Then every character of K extends to a character of G .

Proof. The collection of characters of K which extend to characters of G form a subgroup A of K^* . As G has enough characters to separate points, A separates points of K . So by [Corollary A5.11.3](#), $A = K^*$. \square

A5.11.5 Corollary. Let B be an LCA-group with enough characters to separate points and f a continuous one-one homomorphism of a compact group A into B . Then the map $f^* : B^* \rightarrow A^*$, described in [Proposition A5.9.5](#), is a quotient homomorphism.

Proof. Exercise.

A5.11.6 Theorem. (Pontryagin-van Kampen Duality Theorem for Discrete Groups) Let G be a discrete abelian group and Γ its dual group. Then the canonical map α is a topological group isomorphism of G onto Γ^* .

Proof. As in [Theorem A5.11.2](#), α is a continuous one-one homomorphism of G into Γ^* . As $\alpha(G)$ separates points of Γ and Γ is compact, [Corollary A5.11.3](#) yields that $\alpha(G) = \Gamma$. As G and Γ^* are discrete this completes the proof. \square

We conclude this section by showing how duality theory yields a complete description of compact Hausdorff abelian torsion groups. (Recall that a group G is said to be a **torsion group** if each of its elements is of finite order.) The first step is the following interesting result.

A5.11.7 Definition. Let $G_i, i \in I$, be a set of groups, for some index set I . Then the subgroup $H = \prod_{i \in I}^r G_i$ of the direct product $\prod_{i \in I} G_i$, where $g = (\dots, g_i, \dots) \in H$ if and only if each $g_i \in G_i$ and g_i is the identity element for all but a finite number of $i \in I$, is said to be the **restricted direct product**.

A5.11.8 Theorem. If $G = \prod_{i \in I} G_i$ is the direct product of any family $\{G_i : i \in I\}$ of compact Hausdorff abelian groups, then the discrete group G^* is algebraically isomorphic to the restricted direct product $\prod_{i \in I}^r \Gamma_i$ of the corresponding dual groups $\{\Gamma_i = G_i^* : i \in I\}$.

Proof. Each $g \in G$ may be thought of as a "string" $g = (\dots, g_i, \dots)$, the group operation being componentwise addition. If $\gamma = (\dots, \gamma_i, \dots)$, where $\gamma_i \in \Gamma_i$ and only finitely many γ_i are non-zero, then γ is a character on G defined by $(g, \gamma) = \sum_{i \in I} (g_i, \gamma_i)$, for each $g \in G$. (Observe that this is a finite sum!) Let us denote the subgroup of G^* consisting of all such γ by A . Then A is algebraically isomorphic to the restricted direct product $\prod_{i \in I}^r \Gamma_i$.

We claim that A separates points of G . To see this let $g \in G$, $g \neq 0$. Then $g = (\dots, g_i, \dots)$ with some $g_i \neq 0$. So there is a $\gamma_i \in \Gamma_i$ such that $\gamma_i(g_i) \neq 0$. Putting $\gamma = (\dots, \gamma_j, \dots)$ where $\gamma_j = 0$ unless $j = i$, we see that $\gamma(g) = \gamma_i(g_i) \neq 0$. As $\gamma \in A$, A separates points of G . By [Corollary A5.11.3](#), this implies that $A = G^*$. □

A5.11.9 Corollary. Every countable abelian group is algebraically isomorphic to a quotient group of a countable restricted direct product of copies of \mathbb{Z} .

Proof. Let G be a countable abelian group. Put the discrete topology on G and let Γ be its dual group. Of course Γ is compact and by [Exercises A5.10 #4](#), Γ is topologically isomorphic to a subgroup of a product $\prod_{i \in I} T_i$ of copies of \mathbb{T} , where the cardinality of the index set I equals the cardinality of Γ^* . By [Theorem A5.11.6](#), Γ^* is topologically isomorphic to G . So Γ is topologically isomorphic to a subgroup of a countable product of copies of \mathbb{T} . Taking dual groups and using [Theorem A5.11.8](#) and [Corollary A5.11.5](#) we obtain the required result. □

Of course the above corollary also follows from the fact that the free abelian group on a countable set is a countable restricted direct product of copies of \mathbb{Z} , and that any countable abelian group is a quotient group of the free abelian group on a countable set.

A5.11.10 Remark. Kaplan [227, 228] has investigated generalizations of [Theorem A5.11.7](#) to direct products of non-compact groups. As a direct product of LCA-groups is not, in general, an LCA-group we must first say what we mean by the dual group of a non-LCA-group: If G is any abelian topological group we define Γ to be the group of continuous homomorphisms of G into \mathbb{T} , with the compact open topology. Then Γ is an abelian topological group and we can form Γ^* in the same way. As in the locally compact case there is a natural map α which takes $g \in G$ to $\alpha(g)$ a function from Γ into \mathbb{T} . We can then ask for which groups is α a topological group isomorphism of G onto Γ^* . Such groups will be called **reflexive**.

A satisfactory description of this class is not known, but it includes not only all LCA-groups but also all Banach spaces (considered as topological groups). (See Smith [366].) Kaplan showed that if $\{G_i : i \in I\}$ is a family of reflexive groups then $\prod_{i \in I} G_i$ is also a reflexive group. Its dual group is algebraically isomorphic to the restricted direct product of the family $\{G_i^* : i \in I\}$. The topology of the dual group is slightly complicated to describe, but when I is countable it is simply the subspace topology induced on $\prod_{i \in I}^r G_i^*$ if $\prod_{i \in I} G_i^*$ is given the box topology. In particular this is the case when each G_i is an LCA-group—thus generalizing [Theorem A5.11.7](#).

For further comments on reflexive groups see Brown et al. [60], Venkataraman [403], Noble [318], Varopoulos [401], and Vilenkin [405].

Reflexivity of abelian topological groups, including nuclear groups, has been thoroughly studied in Banaszczyk [30]. For relevant research on reflexivity, see Hofmann and Morris [190], Nickolas [316], Nickolas [315], Chasco et al. [79], Chasco and Martin-Peinador [78], Chasco and DomÍnguez [77], Chasco [76], Barr [34] and Pestov [324].

To prove the structure theorem of compact Hausdorff abelian torsion groups we have to borrow the following result of abelian group theory. (See Fuchs [143].)

A5.11.11 Theorem. An abelian group all of whose elements are of bounded order is algebraically isomorphic to a restricted direct product $\prod_{i \in I}^r Z(b_i)$, with only a finite number of the b_i distinct, where $Z(b_i)$ is the discrete cyclic group with b_i elements.

A5.11.12 Theorem. A compact Hausdorff abelian torsion group is topologically isomorphic to $\prod_{i \in I} Z(b_i)$, where I is some index set and there exist only a finite number of distinct b_i .

Proof. Exercise.

Exercises A5.11

1. If f is a continuous one-one homomorphism of a compact group A into an LCA-group B which has enough characters to separate points, show that the map $f^* : B^* \rightarrow A^*$, described in [Proposition A5.9.5](#), is a quotient homomorphism.
2. Show that every compact Hausdorff abelian torsion group G is topologically isomorphic to a product $\prod_{i \in I} Z(b_i)$, where $Z(b_i)$ is a discrete cyclic group with b_i elements, I is an index set, and there are only a finite number of distinct b_i .

[Hint: Let $G_{(n)} = \{x \in G : nx = 0\}$. Observe that $G = \bigcup_{n=1}^{\infty} G_{(n)}$ and, using the [Baire Category Theorem A5.4.1](#), show that one of the quotient groups $G/G_{(n)}$ is finite.

Deduce that the orders of all elements of G are bounded.

Then use the [structure theorem of abelian groups of bounded order A5.11.11.](#)]

A5.12 Monothetic LCA-groups and Compactly Generated LCA-groups

We have proved the duality theorem for compact groups and for discrete groups. To extend the duality theorem to all LCA-groups we shall prove two special cases of the following proposition:

If G is an LCA-group with a subgroup H such that both H and G/H satisfy the duality theorem, then G satisfies the duality theorem.

The two cases we prove are when H is compact and when H is open.

The duality theorem for all LCA-groups then follows from the fact that every LCA-group G has an open subgroup H which in turn has a compact subgroup K such that H/K is an "elementary group" which is known to satisfy the duality theorem. By an "elementary group" we mean one which is of the form $\mathbb{R}^a \times \mathbb{Z}^b \times \mathbb{T}^c \times F$, where F is a finite discrete abelian group and a , b and c are non-negative integers.

Once we have the duality theorem we use it, together with the above structural result, to prove the Principal Structure Theorem.

We begin with some structure theory.

A5.12.1 Definition. A topological group is said to be **monothetic** if it has a dense cyclic subgroup.

A5.12.2 Examples. \mathbb{Z} and \mathbb{T} are monothetic. □

A5.12.3 Theorem. Let G be a monothetic LCA-group. Then either G is compact or G is topologically isomorphic to \mathbb{Z} .

Proof. If G is discrete then either $G = \mathbb{Z}$ or G is a finite cyclic group and hence is compact. So we have to prove that G is compact if it is not discrete.

Assume G is not discrete. Then the dense cyclic subgroup $\{x_n : n = 0, \pm 1, \pm 2, \dots\}$, where $x_n + x_m = x_{n+m}$ for each n and m , is infinite. (If the cyclic subgroup were finite it would be discrete and hence closed in G . As it is also dense in G , this would mean that it would equal G and G would be discrete.)

Let V be an open symmetric neighbourhood of 0 in G with \bar{V} compact. If $g \in G$, then $V + g$ contains some x_k . So there is a symmetric neighbourhood W of 0 in G such that $(g - x_k) + W \subseteq V$. As G is not discrete, W contains an infinite number of the x_n and as W is symmetric $x_{-n} \in W$ if $x_n \in W$. Hence there exists a $j < k$ such that $x_j \in W$. Putting $i = k - j$ we have $i > 0$ and

$$g - x_i = g - x_k + x_j \in g - x_k + W \subseteq V.$$

This proves that $G = \bigcup_{i=1}^{\infty} (x_i + V)$. (The important point is that we need x_i only for $i > 0$.) As \bar{V} is a compact subset of G we have that

$$\bar{V} \subseteq \bigcup_{i=1}^N (x_i + V), \quad \text{for some } N. \quad (1)$$

For each $g \in G$, let $n = n(g)$ be the smallest positive n such that $g \in x_n + \bar{V}$. By (1), $x_n - g \in x_i + \bar{V}$ for some $1 \leq i \leq N$. So we have that $g \in x_{n-i} + \bar{V}$.

Since $i > 0$, $n - i < n$ and so by our choice of n , $n - i \leq 0$. Thus $n \leq i \leq N$. So for each $g \in G$, $n \leq N$, which means that

$$G = \bigcup_{i=1}^N (x_i + \bar{V})$$

which is a finite union of compact sets and so G is compact. □

A5.12.4 Theorem. A compact Hausdorff abelian group G is monothetic if and only if G^* is topologically isomorphic to a subgroup of \mathbb{T}_d , the circle group endowed with the discrete topology.

Proof. Exercise. □

We now use Theorem [t](#) to obtain our first description of the structure of compactly generated LCA-groups. (Recall that an LCA-group G is said to be **compactly generated** if it has a compact subset V such that G is generated algebraically by V . Without loss of generality V can be chosen to be a symmetric neighbourhood of 0.)

A5.12.5 Proposition. If G is an LCA-group which is algebraically generated by a compact symmetric neighbourhood V of 0, then G has a closed subgroup A topologically isomorphic to \mathbb{Z}^n , for some integer $n \geq 0$, such that G/A is compact and $V \cap A = \{0\}$.

Proof. If we put $V_1 = V$ and inductively define $V_{n+1} = V_n + V$, for each integer $n \geq 1$, then $G = \bigcup_{n=1}^{\infty} V_n$. As V_2 is compact there are elements g_1, \dots, g_m in G such that $V_2 \subseteq \bigcup_{i=1}^m (g_i + V)$. Let H be the group generated by $\{g_1, \dots, g_m\}$. So $V_i \subseteq V + H$, for $i = 1$ and $i = 2$. If we assume that $V_n \subseteq V + H$, then we have

$$V_{n+1} \subseteq V + (V + H) = V_2 + H \subseteq (V + H) + H = V + H.$$

So, by induction, $V_n \subseteq V + H$, for all $n \geq 1$, and hence $G = V + H$.

Let \overline{H}_i be the closure in G of the subgroup H_i generated by g_i , for $i = 1, \dots, m$.

If each H_i is compact, then as $H = H_1 + \dots + H_m$, \overline{H} is compact and so $G = V + \overline{H}$ is compact. (Use [Exercises A5.1 #4](#).) The Proposition would then be true with $n = 0$. If G is not compact, then, by [Theorem A5.12.4](#), one of the monothetic groups \overline{H}_i is topologically isomorphic to \mathbb{Z} . In this case $\overline{H}_i = H_i$ and we deduce that

if $G = V + H$, where H is a finitely generated group, and G is not compact, then H has a subgroup topologically isomorphic to \mathbb{Z} (*)

As H is a finitely generated abelian group (and every subgroup of an abelian group with p generators can be generated by $\leq p$ elements) there is a largest n such that H contains a subgroup A topologically isomorphic to \mathbb{Z}^n . Since A is discrete and V is compact, $A \cap V$ is finite. Without loss of generality we can assume that $A \cap V = \{0\}$. (If necessary we replace A by a subgroup A' which is also topologically isomorphic to \mathbb{Z}^n and has the property that $A' \cap V = \{0\}$. For example, if $A = \text{gp}\{a_1, \dots, a_n\}$ and r is chosen such that $A \cap V \subseteq \{k_1 a_1 + \dots + k_n a_n : 1 - r \leq k_i \leq r - 1, i = 1, \dots, n\}$ then we put $A' = \text{gp}\{ra_1, \dots, ra_n\}$.)

Let f be the canonical homomorphism of G onto $K = G/A$. Then $K = f(V) + f(H)$. By [Exercises A5.12 #2](#) and our choice of n , $f(H)$ has no subgroup topologically isomorphic to \mathbb{Z} . By (*) applied to K instead of G , we see that K is compact, as required. \square

The above proposition allows us to prove a most important theorem which generalizes [Theorem A5.10.1](#).

A5.12.6 Theorem. Every LCA-group has enough characters to separate points.

Proof. Let G be any LCA-group and g any non-zero element of G . Let V be a compact symmetric neighbourhood of 0 which contains g . Then the subgroup H generated algebraically by V is, by [Proposition A5.2.9](#), an open subgroup of G .

By [Proposition A5.12.5](#), H has a closed subgroup A such that H/A is compact and $V \cap H = \{0\}$. Defining f to be the canonical map of H onto H/A we see that $f(g) \neq 0$.

According to [Theorem A5.10.1](#) there is a continuous homomorphism $\phi : H/A \rightarrow \mathbb{T}$ such that $\phi(f(g)) \neq 0$. Then ϕf is a continuous homomorphism of H into \mathbb{T} . As H is an open subgroup of G and \mathbb{T} is divisible, [Proposition A5.3.6](#) tells us that ϕf can be extended to a continuous homomorphism $\gamma : G \rightarrow \mathbb{T}$. Clearly $\gamma(g) \neq 0$ and so G has enough characters to separate points. □

A5.12.7 Corollary. Let H be a closed subgroup of an LCA-group G . If g is any element of G not in H , then there is a character γ of G such that $\gamma(g) \neq 0$ but $\gamma(h) = 0$, for all $h \in H$.

Proof. Exercise. □

The next corollary is an immediate consequence of the opening sentences in the proof of [Theorem A5.12.6](#).

A5.12.8 Corollary. Every LCA-group has a subgroup which is both open and a compactly generated LCA-group. □

A5.12.9 Remarks. [Theorem A5.12.6](#) was first proved by E.R. van Kampen. A proof based on the theory of Banach algebras was given by Israil Moiseevic Gelfand and Dmitrii Abramovich Raikov in Gelfand and Raikov [[152](#)].

The reader should not be misled, by [Theorem A5.12.6](#), into thinking that all Hausdorff abelian topological groups have enough characters to separate points. This is not so. See §23.32 of Hewitt and Ross [[180](#)]. □



Gelfand

The next proposition gives another useful description of the structure of compactly generated LCA-groups.

A5.12.10 Proposition. If G is a compactly generated LCA-group, then it has a compact subgroup K such that G/K is topologically isomorphic to $\mathbb{R}^a \times \mathbb{Z}^b \times \mathbb{T}^c \times F$, where F is a finite discrete abelian group and a , b and c are non-negative integers.

Proof. By [Proposition A5.12.5](#) there exists a discrete finitely generated subgroup D of G such that G/D is compact. Let N be a compact symmetric neighbourhood of 0 such that $3N \cap D = \{0\}$. If $f : G \rightarrow G/D$ is the canonical homomorphism then $f(N)$ is a neighbourhood of 0 in G/D and, by [Corollary A5.12.8](#), there exists a closed subgroup $B \subseteq f(N)$ such that $(G/D)/B$ is topologically isomorphic to $\mathbb{T}^n \times E$, where E is a finite discrete group and $n \geq 0$. If we let $K' = f^{-1}(B)$ then we see that G/K' is topologically isomorphic to $\mathbb{T}^n \times E$.

Putting $K = K' \cap N$, we have that K is compact and $f(K) = B$. To see that K is a subgroup of G , let x and y be in K . Then $x - y \in K'$, so there is a $z \in K$ such that $f(z) = f(x - y)$. This implies that $x - y - z \in D$, and since $3N \cap D = \{0\}$ it follows that $x - y - z = 0$; that is, $x - y \in K$ and so K is a subgroup of G .

We claim that $K' = K + D$. For if $k' \in K'$, there is a $k \in K$ such that $f(k') = f(k)$ and so $k' - k \in D$. Thus $K' = K + D$. By [Exercises A5.4 #7](#), K' is topologically isomorphic to $K \times D$. Hence if θ is the canonical map of G onto G/K then $\theta(D)$ is topologically isomorphic to D and $(G/K)/\theta(D)$ is topologically isomorphic to G/K' which is in turn topologically isomorphic to $\mathbb{T}^n \times E$. As $\theta(D)$ and E are discrete, [Exercises A5.5 #7](#) tells us that G/K is locally isomorphic to \mathbb{T}^n and hence also to \mathbb{R}^n . [Theorem A5.5.25](#) then says that G/K is topologically isomorphic to $\mathbb{R}^a \times \mathbb{T}^c \times S$, where S is a discrete group and $a \geq 0$ and $c \geq 0$. As G is compactly generated G/K and hence also S are compactly generated. So S is a discrete finitely generated abelian group and thus is topologically isomorphic to $\mathbb{Z}^b \times F$, for some finite discrete group G and $b \geq 0$. □

Exercises A5.12

1. (i) Let f be a continuous homomorphism of an LCA-group A into an LCA-group B . If $f(A)$ is dense in B , show that the map $f^* : B^* \rightarrow A^*$, described in [Proposition A5.9.5](#), is one-one.
 - (ii) Show that if G is a compact Hausdorff abelian group which is monothetic then G^* is topologically isomorphic to a subgroup of \mathbb{T}_d , the circle group endowed with the discrete topology.
[Hint: Use (i) with $A = \mathbb{Z}$ and $B = G$.]
 - (iii) Let A be an LCA-group which satisfies the duality theorem and B an LCA-group. If f is a continuous one-one homomorphism of A into B show that $f^*(B^*)$ is dense in A^* .
[Hint: See the proof of [Corollary A5.11.4](#) and use [Proposition A5.9.10](#) and [Theorem A5.12.6](#).]
 - (iv) Show that if G is a compact Hausdorff abelian group with G^* topologically isomorphic to a subgroup of \mathbb{T}_d , then G is monothetic.
2. Let A and B be LCA-groups and H a (not necessarily closed) finitely generated subgroup of A . If f is a continuous homomorphism of A into B such that the kernel of f lies wholly in H and is topologically isomorphic to \mathbb{Z}^n , for some $n \geq 1$, and such that $f(H)$ contains a subgroup topologically isomorphic to \mathbb{Z} , show that H contains a subgroup topologically isomorphic to \mathbb{Z}^{n+1} .
[Hint: Use [Corollary A5.4.3](#).]
3. If H is a closed subgroup of an LCA-group G and g is an element of G not in H , show that there is a character γ of G such that $\gamma(g) \neq 0$ but $\gamma(h) = 0$, for all $h \in H$.

4. Let G be a locally compact Hausdorff group.
- (i) Prove that G is a k_ω -space if and only if it is σ -compact. (See [Exercises 10.3 #5](#) for the definition of k_ω -space.)
 - (ii) If G is σ -compact, show that the X_n in the k_ω -decomposition can be chosen to be neighbourhoods of e .
[Hint: As G is σ -compact, $G = \bigcup_{n=1}^{\infty} Y_n$ where each Y_n is compact. Let V be a compact symmetric neighbourhood of e and put $X_n = Y_1 V \cup Y_2 V \cup \cdots \cup Y_n V$.]
 - (iii) **Every connected locally compact Hausdorff group is a k_ω -space.**
 - (iv) G has an open neighbourhood U of 1 such that \bar{U} is a compact neighbourhood of 1.
 - (v) The subgroup $\text{gp}(U)$ of G generated algebraically by U is open in G .
 - (vi) The subgroup $\text{gp}(\bar{U})$ of G generated algebraically by \bar{U} is open in G , and so $\text{gp}(\bar{U})$ is an open locally compact σ -compact subgroup of G .
 - (vii) (Glöckner et al. [160]) A topological space (X, \mathcal{T}) is said to be a **locally k_ω -space** if each point in (X, \mathcal{T}) has an open neighbourhood which is a k_ω -space. Prove that **every locally compact Hausdorff group is a locally k_ω -space.**
 - (viii) Verify that every discrete space, every compact Hausdorff space, every k_ω -space, and every closed subspace of a locally k_ω -space is a locally k_ω -space.
 - (ix) Verify that every metrizable k_ω -space is separable but not every metrizable locally k_ω -space is separable.
 - (x) Prove that **every locally k_ω -space is a k -space.**

5. Let \mathcal{P} be a property of topological groups; that is if topological groups G and H are topologically isomorphic then G has property \mathcal{P} if and only if H has property \mathcal{P} . The property \mathcal{P} is said to be a **three space property** if whenever G is any topological group with a closed normal subgroup N and the topological groups N and G/N have property \mathcal{P} , then G has property \mathcal{P} . (See Bruguera and Tkachenko [64].)

- (i) Prove that “being a finite group” is a three space property.
- (ii) Prove that “being a finitely generated group” is a three space property.
- (iii) Prove that for any given infinite cardinal m , “being a topological group of cardinality $\leq m$ ” is a three space property.
- (iv) Prove that “being a discrete group” is a three space property.
- (v) Let G be a locally compact Hausdorff group and N a closed normal subgroup of G . If $f : G \rightarrow G/N$ is the canonical map, show that for each compact subset C of G/N there exists a compact subset S of G such that $f(S) = C$.
- (vi) Deduce that if N is a closed normal subgroup of a locally compact Hausdorff group G such that both N and G/N are compactly generated, then G is also compactly generated. So **“being a compactly generated locally compact Hausdorff group” is a three space property.**
- (vii) If in (v), N is also compact show that $f^{-1}(C)$ is compact.
- (viii) Deduce that if G is a Hausdorff topological group having a normal subgroup K such that both K and G/K are compact, then G is compact. So **“being a compact Hausdorff group” is a three space property.**

A5.13 The Duality Theorem and the Principal Structure Theorem

A5.13.1 Definition. Let A , B , and C be topological groups, f_1 a continuous homomorphism of A into B and f_2 a continuous homomorphism of B into C . The sequence

$$0 \longrightarrow A \xrightarrow{f_1} B \xrightarrow{f_2} C \longrightarrow 0$$

is said to be **exact** if (i) f_1 is one-one; (ii) f_2 is onto; and (iii) the kernel of f_2 equals $f_1(A)$.

A5.13.2 Proposition. Let K be a compact subgroup of an LCA-group G , so that we have an exact sequence

$$0 \longrightarrow K \xrightarrow{f_1} G \xrightarrow{f_2} G/K \longrightarrow 0$$

where f_2 is an open continuous homomorphism and f_1 is a homeomorphism of K onto its image in G . Then the sequence

$$0 \longleftarrow K^* \xleftarrow{f_1^*} G^* \xleftarrow{f_2^*} (G/K)^* \longleftarrow 0$$

is exact and f_1^* and f_2^* are open continuous homomorphisms.

Proof. By Proposition A5.9.5, f_2^* is one-one. Using Corollary A5.11.5 together with Theorem A5.12.6 we see that f_1^* is both open and onto. To see that the image of f_2^* equals the kernel of f_1^* consider the diagram

$$\begin{array}{ccccccc} 0 & \longrightarrow & K & \xrightarrow{f_1} & G & \xrightarrow{f_2} & G/K \longrightarrow 0 \\ & & & & & & \downarrow \gamma \\ & & & & & & \mathbb{T} \\ & & & & & & \uparrow f_2^*(\gamma) \\ & & & & & & \downarrow f_1^* f_2^*(\gamma) \\ & & & & & & \mathbb{T} \end{array}$$

Let γ be any character of G/K and k any element of K . Then

$$f_1^* f_2^* \gamma(k) = \gamma f_2 f_1(k) = 0$$

as the given sequence is exact. Therefore $f_1^* f_2^*(\gamma) = 0$ and so $\text{Image } f_2^* \subseteq \text{Kernel } f_1^*$. Now if $\phi \in G^*$ and $f_1^*(\phi) = 0$, then we have $\phi f_1(k) = 0$ for all $k \in K$. So there exists a homomorphism $\delta : G/K \rightarrow \mathbb{T}$ such that $\delta f_2 = \phi$. As f_2 is both open and onto, δ is continuous. So $\text{Kernel } f_1^* \subseteq \text{Image } f_2^*$. Hence $\text{Image } f_2^* = \text{Kernel } f_1^*$.

Finally we have to show that f_2^* is an open map. Let C be a compact subset of G/K , U an open subset of \mathbb{T} and $P(C, U)$ the set of all elements of $(G/K)^*$ which map C into U . Then $P(C, U)$ is a sub-basic open set in $(G/K)^*$. Now by Exercises A5.12 #5(i) there exists a compact subset S of G such that $f_2(S) = C$. Thus we see that $P(S, U)$ is a sub-basic open subset of G^* such that $f_2^*(P(C, U)) = P(S, U) \cap f_2^*((G/K)^*)$. So f_2^* is a homeomorphism of $(G/K)^*$ onto its image in G^* . As K^* is discrete, $\text{Kernel } f_1^*$ is open in G^* ; that is, $\text{Image } f_2^*$ is open in G^* . So f_2^* is an open map. \square

A5.13.3 Proposition. Let A be an open subgroup of an LCA-group G , so that we have an exact sequence

$$0 \longrightarrow A \xrightarrow{f_1} G \xrightarrow{f_2} G/A \longrightarrow 0$$

where the homomorphisms f_1 and f_2 are open continuous maps. Then the sequence

$$0 \longleftarrow A^* \xleftarrow{f_1^*} G^* \xleftarrow{f_2^*} (G/A)^* \longleftarrow 0$$

is exact, f_1^* is open and continuous and f_2^* is a homeomorphism of $(G/A)^*$ onto its image in G^* .

Proof. By [Proposition A5.9.5](#), f_1^* is onto and f_2^* is one-one. That $\text{Image } f_2^* = \text{Kernel } f_1^*$ is proved exactly as in [Proposition A5.13.2](#). As A is open in G , G/A is discrete and $(G/A)^*$ is compact. As f_2^* is one-one and $(G/A)^*$ is compact, f_2^* is a homeomorphism of $(G/A)^*$ onto its image in G^* .

Finally we have to show that f_1^* is an open map. Let K be a compact neighbourhood of 0 in G which lies in A . If V_a is as in [Corollary A5.7.7](#), then $P(K, V_a)$ is an open set in G^* such that $\overline{P(K, V_a)}$ is compact. Of course, $f_1^*(P(K, V_a))$ consists of those elements of A^* which map K into V_a , and so is open in A^* . If we put H equal to the group generated by $f_1^*(P(K, V_a))$ then H is an open subgroup of A^* . Furthermore as $\text{gp}\{P(K, V_a)\}$ is an open and closed subgroup of G^* , $\overline{P(K, V_a)} \subseteq \text{gp}\{P(K, V_a)\} = B$. As B is generated by $\overline{P(K, V_a)}$ it is σ -compact. The [Open Mapping Theorem A5.4.4](#) then implies that $f_1^* : B \rightarrow H$ is open. As B is an open subgroup of G^* and H is an open subgroup of A^* , $f_1^* : G^* \rightarrow A^*$ is open. \square

The next Proposition is a corollary of the 5-Lemma of category theory. (See https://en.wikipedia.org/wiki/Short_five_lemma.) It is easily verified by "diagram-chasing".

A5.13.4 Proposition. Let A, B, C, D, E and F be abelian topological groups and $f_1, f_2, f_3, f_4, f_5, f_6$ and f_7 be continuous homomorphisms as indicated in the diagram below.

$$\begin{array}{ccccccccc}
 0 & \longrightarrow & A & \xrightarrow{f_1} & B & \xrightarrow{f_2} & C & \longrightarrow & 0 \\
 & & \downarrow f_5 & & \downarrow f_6 & & \downarrow f_7 & & \\
 0 & \longrightarrow & D & \xrightarrow{f_3} & E & \xrightarrow{f_4} & F & \longrightarrow & 0
 \end{array}$$

Let each of the horizontal sequences be exact and let the diagram be commutative (that is, $f_3f_5 = f_6f_1$ and $f_4f_6 = f_7f_2$). If f_5 and f_7 are algebraically isomorphisms (that is, both one-one and onto) then f_6 is also an algebraic isomorphism. \square

We now prove the Pontryagin van-Kampen Duality Theorem for compactly generated LCA-groups.

A5.13.5 Theorem. Let G be a compactly generated LCA-group and Γ its dual group. Then the canonical map α of G into Γ^* is a topological group isomorphism of G onto Γ^* .

Proof. By [Proposition A5.12.10](#), G has a compact subgroup K such that G/K is topologically isomorphic to $\mathbb{R}^a \times \mathbb{Z}^b \times \mathbb{T}^c \times F$, where F is a finite discrete abelian group and a, b , and c are non-negative integers. So we have an exact sequence

$$0 \longrightarrow K \xrightarrow{f_1} G \xrightarrow{f_2} G/K \longrightarrow 0$$

Applying [Proposition A5.13.2](#) to this sequence and [Proposition A5.13.3](#) to the dual sequence, we obtain that the sequence

$$0 \longrightarrow K^{**} \xrightarrow{f_1^{**}} \Gamma^* \xrightarrow{f_2^{**}} (G/K)^{**} \longrightarrow 0$$

is also exact. It is easily verified that the diagram

$$\begin{array}{ccccccc} 0 & \longrightarrow & K & \xrightarrow{f_1} & G & \xrightarrow{f_2} & G/K & \longrightarrow & 0 \\ & & \alpha_K \downarrow & & \downarrow \alpha & & \downarrow \alpha_{G/K} & & \\ 0 & \longrightarrow & K^{**} & \xrightarrow{f_1^{**}} & \Gamma^* & \xrightarrow{f_2^{**}} & (G/K)^{**} & \longrightarrow & 0 \end{array}$$

is commutative, where α_K and $\alpha_{G/K}$ are the canonical maps. As we have already seen that K and G/K satisfy the duality theorem, α_K and $\alpha_{G/K}$ are both topological isomorphisms. This implies, by [Proposition A5.13.4](#), that α is an algebraic isomorphism. As α is continuous and G is compactly generated, the [Open Mapping Theorem A5.4.4](#) then implies that α is an open map, and hence a topological isomorphism. \square

At long last we can prove the Pontryagin van-Kampen Duality for all LCA-groups.

A5.13.6 Theorem. [Pontryagin-van Kampen Duality Theorem] Let G be an LCA-group and Γ its dual group. Then the canonical map α of G into Γ^* is a topological group isomorphism of G onto Γ^* .

By [Corollary A5.12.8](#), G has an open subgroup A which is compactly generated. So we have an exact sequence

$$0 \longrightarrow A \xrightarrow{f_1} G \xrightarrow{f_2} G/A \longrightarrow 0$$

Applying [Proposition A5.13.3](#) and then [Proposition A5.13.2](#) yields the exact sequence

$$0 \longrightarrow A^{**} \xrightarrow{f_1^{**}} \Gamma^* \xrightarrow{f_2^{**}} (G/A)^{**} \longrightarrow 0$$

and the commutative diagram

$$\begin{array}{ccccccc} 0 & \longrightarrow & A & \xrightarrow{f_1} & G & \xrightarrow{f_2} & G/A & \longrightarrow & 0 \\ & & \alpha_A \downarrow & & \downarrow \alpha & & \downarrow \alpha_{G/A} & & \\ 0 & \longrightarrow & A^{**} & \xrightarrow{f_1^{**}} & \Gamma^* & \xrightarrow{f_2^{**}} & (G/A)^{**} & \longrightarrow & 0. \end{array}$$

As A is a compactly generated LCA-group and G/A is a discrete group, both A and G/A satisfy the duality theorem and so α_A and $\alpha_{G/A}$ are topological isomorphisms. By [Proposition A5.13.4](#), α is an algebraic isomorphism. Since f_1 , f_1^{**} and α_A are all open maps and $\alpha f_1 = f_1^{**} \alpha_A$, we see that α is also an open map, and hence a topological isomorphism. \square

We can now prove the structure theorem for compactly generated LCA-groups, from which the Principal Structure Theorem for all LCA-groups is a trivial consequence.

A5.13.7 Theorem. Let G be a compactly generated LCA-group. Then G is topologically isomorphic to $\mathbb{R}^a \times \mathbb{Z}^b \times K$, for some compact abelian group K and non-negative integers a and b .

Proof. By Proposition A5.12.10, we have an exact sequence

$$0 \longrightarrow C \xrightarrow{f_1} G \xrightarrow{f_2} \mathbb{R}^a \times \mathbb{Z}^b \times \mathbb{T}^c \times F \longrightarrow 0$$

where C is a compact group, F is a finite discrete group and a , b and c are non-negative integers. By Proposition A5.13.2, we, therefore, have an exact sequence

$$0 \longleftarrow C^* \xleftarrow{f_1^*} G^* \xleftarrow{f_2^*} \mathbb{R}^a \times \mathbb{T}^b \times \mathbb{Z}^c \times F \longleftarrow 0$$

where f_2^* is an open map. So G^* has an open subgroup topologically isomorphic to $\mathbb{R}^a \times \mathbb{T}^b$. As \mathbb{R} and \mathbb{T} are divisible groups, Proposition A5.3.8 says that G^* is topologically isomorphic to $\mathbb{R}^a \times \mathbb{T}^b \times D$, for some discrete group D . As G satisfies the duality theorem, G is topologically isomorphic to G^{**} which in turn is topologically isomorphic to $\mathbb{R}^a \times \mathbb{Z}^b \times K$, where K is the compact group D^* . \square

Since every LCA-group has an open compactly generated subgroup we obtain the Principal Structure Theorem for LCA-groups.

A5.13.8 Theorem. [Principal Structure Theorem for LCA-Groups] Every LCA-group has an open subgroup topologically isomorphic to $\mathbb{R}^a \times K$, for some compact abelian group K and non-negative integer a . \square

As an immediate consequence we have the following significant result.

A5.13.9 Theorem. Every connected LCA-group is topologically isomorphic to $\mathbb{R}^a \times K$, where K is a compact connected abelian group and a is a non-negative integer. \square

A5.13.10 Remarks.

- (i) [Theorem A5.13.7](#) generalizes the well-known result that every finitely generated abelian group is the direct product of a finite number of copies of the infinite cyclic group with a finite abelian group.
- (ii) One might suspect that one could improve upon the [Principal Structure Theorem for LCA-Groups A5.13.8](#) and show that every LCA-group is topologically isomorphic to $\mathbb{R}^a \times K \times D$, where K is compact, D is discrete and a is a non-negative integer. Unfortunately, as the following example shows, this statement is false. \square

A5.13.11 Example. Let G be the group $\prod_{i=1}^{\infty} H_i$, where each H_i is a cyclic group of order four. Let C be the subgroup of G consisting of all elements $g \in G$ such that $2g = 0$. Then C is algebraically isomorphic to $\prod_{i=1}^{\infty} C_i$, where each C_i is a cyclic group of order two. Put the discrete topology on each C_i and the product topology on C . So C is a compact totally disconnected topological group.

Define a topology on G as follows: A base of open neighbourhoods at 0 in G consists of all the open subsets of C containing 0. With this topology G is a totally disconnected LCA-group having C as an open subgroup.

Suppose that G is topologically isomorphic to $\mathbb{R}^a \times K \times D$, where K is a compact abelian group, D is a discrete abelian group, and a is a non-negative integer. As G is totally disconnected, $a = 0$. Further, as G is not compact, D must be infinite.

By the [Principal Structure Theorem for LCA-Groups A5.13.8](#), G has an open subgroup H . As G is totally disconnected $a = 0$. topologically isomorphic to $\mathbb{R}^a \times C$, where C is compact and a is a non-negative integer. Suppose that G is topologically isomorphic to $H \times D$, where D is a discrete subgroup of G . As G is not compact D must be infinite

As D is discrete and C is compact, $D \cap C$ is finite.

If $x \in D$, then $2x \in D \cap C$. If $2x = 2y$, for $y \in D$, then $2(x - y) = 0$, and so $x - y \in D \cap C$. As $D \cap C$ is finite, $2x = 2y$ for only a finite number of $y \in D$. Hence D is finite. This is a contradiction and so our supposition is false. \square

Exercises A5.13

1. Show that if G is an LCA-group such that G and its dual group are connected, then G is topologically isomorphic to \mathbb{R}^n , for some non-negative integer n .
2. Show that **an LCA-group G has enough continuous homomorphisms into \mathbb{R} to separate points if and only if G is topologically isomorphic to $\mathbb{R}^n \times D$, where D is a discrete torsion-free abelian group.**
 [Hint: a compact group admits no nontrivial continuous homomorphisms into \mathbb{R} .]
3. Describe the compactly generated LCA-groups which are topologically isomorphic to their dual groups.
4. A topological group G is said to be **solenoidal** if there exists a continuous homomorphism f of \mathbb{R} into G such that $\overline{f(\mathbb{R})} = G$.
 - (i) Show that if G is also locally compact Hausdorff, then G is either a compact connected abelian group or is topologically isomorphic to \mathbb{R} .
 [Hint : Observe that $\overline{f(\mathbb{R})}$ is topologically isomorphic to $R_1 \times R_2 \times \cdots \times R_n \times K$, where each R_i is a copy of \mathbb{R} . Let p_i be the projection of $\overline{f(\mathbb{R})}$ onto R_i and note that $p_i f$ is a continuous homomorphism of \mathbb{R} into R_i .]
 - (ii) Show that if G is a compact Hausdorff solenoidal group then the dual group of G is topologically isomorphic to a subgroup of \mathbb{R}_d , the additive group of real numbers with the discrete topology.
5. Let F be a field with a topology such that the algebraic operations are continuous. (The additive structure of F , then, is an abelian topological group.) Show that if F is locally compact Hausdorff and connected then F , as a topological group, is isomorphic to \mathbb{R}^n , for some positive integer n . (A further analysis would show that F is either the real number field \mathbb{R} ($n = 1$), the complex number field ($n = 2$) or the quaternionic field ($n = 4$).)

6. Show that if G is any LCA-group then there exists a continuous one-one homomorphism β of G into a dense subgroup of a compact Hausdorff abelian group. Prove this by two different methods.

[Hint: (1) Use the fact that any LCA-group has enough characters to separate points.

(2) Alternatively, let Γ be the dual group of G and Γ_d the group Γ endowed with the discrete topology. Put $K = (\Gamma_d)^*$ and let β be defined by

$$(g, \gamma) = (\gamma, \beta(g)), \quad g \in G, \gamma \in \Gamma.$$

The group $K = (\Gamma_d)^*$ is called the **Bohr compactification** of G .



Harald Bohr (left) and Niels Bohr

Harald Bohr (1887–1951) was a Jewish Danish mathematician and younger brother of the Nobel prize-winning physicist Niels Bohr. Harald did research in mathematical analysis with the Cambridge University mathematician, G.H. Hardy, and Harald was the founder of the theory of almost-periodic functions. He was also a member of the Danish Football Team which won a silver medal in the 1908 Olympics.]

7. A topological group G is said to be **maximally almost periodic (MAP)** if there exists a continuous one-to-one homomorphism of G into a compact Hausdorff group.

(i) Verify that every compact Hausdorff is maximally almost periodic.

(ii) Using [Exercises A5.13 #6](#), verify that every LCA-group is a MAP-group.

8. A topological group G is said to be **minimally almost periodic (m.a.p.)** (von Neumann [411], von Neumann and Wigner [412]) if there every continuous homomorphism ϕ of G into every compact Hausdorff group satisfies $\phi(g) = 1$, for each $g \in G$; that is, every continuous homomorphism of G into a compact Hausdorff group is trivial. A group H is said to be **simple** if it has no normal subgroups other than 1 and H . A topological group S is said to be **topologically simple** if its only closed normal subgroups are 1 and S .

(i) Verify that every simple group with the discrete topology is topologically simple.

(ii) Verify that every infinite topologically simple group is minimally almost periodic.

(iii) Verify that no infinite abelian group is a simple group.

It is easy to verify that there exist infinite simple groups, which by (i) and (ii) above show that there exist minimally almost periodic groups. Let \aleph be any infinite cardinal number and S a set of cardinality \aleph . Let A_\aleph be the group of all even permutations of S which fix all but a finite number of members of S . That A_\aleph is a simple group follows easily from 3.2.4 of Robinson [342]

The concept of minimally periodic group was introduced by John von Neumann and in a subsequent paper with Nobel prize-winning physicist Eugene Paul Wigner (1902-1995) proved that the Special Linear group $SL(2, \mathbb{C})$ with even the discrete topology is a m.a.p. group. Dieter Remus (Remus [338]) proved that every free abelian group and every infinite divisible abelian group admits a m.a.p. topology. Saak Gabrielyan (Gabrielyan [146]) proved that every infinitely-generated abelian group admits a m.a.p. topology.



Wigner

9. Let Γ be any LCA-group and $\gamma_1, \dots, \gamma_n \in \Gamma$. If ϕ is any homomorphism of Γ into \mathbb{T} , show that there is a continuous homomorphism ψ of Γ into \mathbb{T} such that $|\psi(\gamma_i) - \phi(\gamma_i)| < \varepsilon$, $i = 1, \dots, n$.
[Hint: Use [Exercises A5.13 #6](#), method (2).]
10. A topological group G is said to be **almost connected** if G/G_0 is a compact group, where G_0 is the connected component of the identity in G .
- (i) Using [Exercises A5.13 #5\(vi\)](#), prove that every almost connected locally compact group is compactly generated.
 - (ii) Deduce from (i) above and [Theorem A5.13.7](#) that **every almost connected locally compact abelian group is topologically isomorphic to $\mathbb{R}^n \times K$, where K is a compact abelian group and n is a non-negative integer.**
 - (iii) Using [Exercises A5.12.5\(vi\)](#) and (ii) above, prove that **“being an almost connected LCA-group” is a three space property.** (See [Exercises A5.12 #5](#) for the definition and examples of the three space property”.)

A5.14 Consequences of the Duality Theorem

Part One: Kronecker’s Theorem

We begin this section by showing that the dual of a subgroup is a quotient group and the dual of a quotient group is a subgroup.

A5.14.1 Definition. Let H be a closed subgroup of the LCA-group G and Ω the set of all γ in the dual group Γ of G such that $(h, \gamma) = 0$, for all $h \in H$. Then Ω is called the **annihilator** of H .

For fixed $h \in H$, the continuity of (h, γ) shows that the set of all γ with $(h, \gamma) = 0$ is closed, so that Ω is the intersection of closed sets and is therefore closed. Clearly Ω is a group and so it is a closed subgroup of Γ .

A5.14.2 Proposition. With the above notation, if Ω is the annihilator of H , then H is the annihilator of Ω .

Proof. If $h \in H$, then $(h, \gamma) = 0$ for all $\gamma \in \Omega$. If $g \in G$ and $g \notin H$ then, by [Corollary A5.12.7](#) there is a $\gamma \in \Omega$ such that $(g, \gamma) \neq 0$. \square

A5.14.3 Theorem. Let H be a closed subgroup of an LCA-group G . If Γ is the dual group of G and Ω is the annihilator of H , then Ω and Γ/Ω are topologically isomorphic to the dual groups of G/H and H , respectively.

Proof. Let f be the canonical homomorphism of G onto G/H . Then [Proposition A5.9.5](#) says that the map $f^* : (G/H)^* \rightarrow G^*$ is a continuous one-one homomorphism. Further, the last paragraph of the proof of [Proposition A5.13.3](#) shows that f^* is a homeomorphism of $(G/H)^*$ onto its image in G^* . Of course the definition of f^* tells us that $f^*((G/H)^*) = \Omega$, and so Ω is topologically isomorphic to $(G/H)^*$.

The fact that Γ/Ω is topologically isomorphic to H^* then follows from the above, together with [Proposition A5.14.2](#) and the duality theorem. \square

As a corollary we have the following generalization of [Corollary A5.11.4](#).

A5.14.4 Corollary. If H is a closed subgroup of an LCA-group G , then every character on H can be extended to a character on G .

Proof. If ϕ is a character on H , then by [Theorem A5.14.3](#), $\phi \in \Gamma/\Omega$. If f is the canonical homomorphism of Γ onto Γ/Ω and $f(\gamma) = \phi$, $\gamma \in \Gamma$, then $(h, \gamma) = (h, \phi)$, for all $h \in H$. So γ is the required extension of ϕ . \square

We now record an application in the area of diophantine approximation.

Firstly observe that the definition of the annihilator of a subgroup H of an LCA-group G would make sense even if H were not closed in G . However it is obvious that the annihilator of H , $\Omega(H)$, would equal $\Omega(\overline{H})$. We will see that this observation is quite useful.

A5.14.5 Proposition. Let G be a (not necessarily closed) subgroup of \mathbb{R}^n , $n \geq 1$. Let $\Omega(G)$ denote the annihilator of G in $(\mathbb{R}^n)^* = \mathbb{R}^n$. then $\Omega(G) = \{y \in \mathbb{R}^n : (y|x) \text{ is an integer for each } x \in G\}$, where $y = (y_1, \dots, y_n) \in \mathbb{R}^n$, $x = (x_1, \dots, x_n) \in G \subseteq \mathbb{R}^n$ and $(y|x) = \sum_{i=1}^n y_i x_i$.

Proof. Exercise. □

As an immediate consequence of [Proposition A5.14.2](#) we have the following result.

A5.14.6 Proposition. If G is any subgroup of \mathbb{R}^n , $n \geq 1$, then $\Omega(\Omega(G)) = \overline{G}$.

Translating [Proposition A5.14.6](#) using [Proposition A5.14.5](#) we obtain a characterization of those points lying in the closure of a subgroup of \mathbb{R}^n .

A5.14.7 Proposition. A point x lies in the closure of a subgroup G of \mathbb{R}^n , $n \geq 1$ if and only if $(y|x)$ is an integer for all $y \in \mathbb{R}^n$ such that $(y|g)$ is an integer for all $g \in G$.

We apply this characterization to the case where G is the subgroup of \mathbb{R}^n , $n \geq 1$ generated by the vectors e_1, \dots, e_n of the canonical basis and by an arbitrary number m of points a_i , $i = 1, \dots, m$ of \mathbb{R}^n . To say that $(y|e_i)$ is an integer, for $i = 1, \dots, n$ means that each coordinate of y is an integer. So we obtain the following theorem of the German mathematician Leopold Kronecker (1823–1891). [Kronecker once said: “Die ganzen Zahlen hat der liebe Gott gemacht, alles andere ist Menschenwerk” (“God made the integers, all else is the work of man.”)]



Kronecker

A5.14.8 Theorem. (Kronecker) Let $a_i = (a_{i1}, \dots, a_{in})$ for $i = 1, \dots, m$ and $b = (b_1, \dots, b_n)$ be points of \mathbb{R}^n , $n \geq 1$. In order that for each $\varepsilon > 0$ there exists integers q_1, \dots, q_m and integers p_1, \dots, p_n such that

$$|q_1 a_{1j} + q_2 a_{2j} + \dots + q_m a_{mj} - p_j b_j| \leq \varepsilon \quad \text{for } j = 1, \dots, n$$

it is necessary and sufficient that for each finite sequence r_1, \dots, r_n of integers such that the numbers $\sum_{j=1}^n a_{ij} r_j$, for $i = 1, \dots, m$, are all integers, the number $\sum_{j=1}^n b_j r_j$ should also be an integer.

Putting $m = 1$ we obtain the following corollary which is a generalization of [Exercise Set A5.5 #3 \(ii\)](#).

A5.4.19 Corollary. Let $\theta_1, \dots, \theta_n$ be real numbers. In order that, given any n real numbers x_1, \dots, x_n and a real number $\varepsilon > 0$, there should exist an integer q and n integers p_j such that

$$|q\theta_j - p_j - x_j| \leq \varepsilon \quad \text{for } j = 1, \dots, n$$

it is necessary and sufficient that there exist no relation of the form

$$\sum_{j=1}^n r_j \theta_j = h,$$

where the r_j are integers not all zero and h is an integer. (In particular this implies that the θ_j and the ratios θ_j/θ_k , $j \neq k$, must be irrational.)

For some further comments in this area of approximation see Hewitt and Ross [[180](#), §26.19] and Bourbaki [[51](#), §1.3 of Vol. 2].

Exercises A5.14

1. Prove that a closed subgroup of a compactly generated LCA-group is compactly generated.
Kenneth Ross in Ross [[346](#)] defined a (necessarily compactly generated) topological group a **Moskowitz-Morris group** if each closed subgroup of it is compactly generated. This exercise shows that every compactly generated LCA-group is a Moskowitz-Morris group.
[Hint: Use [Corollary A5.5.18](#).]
2. (i) Show that any closed subgroup of $\mathbb{R}^n \times \mathbb{T}^m$ is topologically isomorphic to $\mathbb{R}^a \times \mathbb{Z}^b \times \mathbb{T}^c \times D$, where D is a discrete finite group, $a + b \leq n$ and $c \leq m$.
(ii) Show that any Hausdorff quotient group of $\mathbb{R}^n \times \mathbb{T}^m$ is topologically isomorphic to $\mathbb{R}^a \times \mathbb{T}^b$ with $a \leq n$ and $a + b \leq n + m$.

- (iii) Show that any closed subgroup of $\mathbb{R}^n \times \mathbb{T}^m \times F$, where F is a discrete free abelian group, is topologically isomorphic to $\mathbb{R}^a \times \mathbb{Z}^b \times \mathbb{T}^c \times D \times F'$, where $a + b \leq n$, $c \leq m$, D is a discrete finite group and F' is a subgroup of F .
- (iv) Show that any closed subgroup of $\mathbb{R}^n \times \mathbb{T}^m \times D$, where D is a discrete abelian group, is topologically isomorphic to $\mathbb{R}^a \times \mathbb{T}^b \times D'$, where D' is a discrete group, $a \leq n$ and $b \leq m$.
- (v) Show that any Hausdorff quotient of $\mathbb{R}^n \times \mathbb{T}^m \times D$, where D is a discrete abelian group, is topologically isomorphic to $\mathbb{R}^a \times \mathbb{T}^b \times D'$, where D' is a discrete group, $a \leq n$ and $a + b \leq n + m$.
- (vi) Hence show that any closed subgroup or Hausdorff quotient group of $\mathbb{R}^n \times \mathbb{Z}^m \times K$, where K is a compact Hausdorff abelian group, is topologically isomorphic to $\mathbb{R}^a \times \mathbb{Z}^b \times K'$, where K' is a compact group, $a \leq n$ and $a + b \leq n + m$.
3. Let G be a compactly generated LCA-group. Assuming the structural result [Proposition A5.12.5](#) which says that G has a subgroup A topologically isomorphic to \mathbb{Z}^n , $n \geq 0$, such that G/A is compact, show that G^* is locally isomorphic to \mathbb{R}^n . Hence prove that G is topologically isomorphic to $\mathbb{R}^a \times \mathbb{Z}^b \times K$, where $a + b = n$ and K is compact.
4. Let G be any LCA-group. Assuming the structural result [Theorem A5.13.9](#) which says that every connected LCA-group is topologically isomorphic to $\mathbb{R}^a \times K$, for some compact group K and $a \geq 0$, prove the [Principal Structure Theorem A5.13.9](#).
[Hint: Let C be the component of 0 in G and observe that [Exercises A5.3 #4\(i\)](#) says that G/C has a compact open subgroup A . So G has an open subgroup H with the property that H/C is compact. Deduce that H^* is locally isomorphic to \mathbb{R}^n .]
5. Let G be a compactly generated LCA-group. Assuming the [Principal Structure Theorem A5.13.9](#) show that G is topologically isomorphic to $\mathbb{R}^a \times \mathbb{Z}^b \times K$, where K is compact, $a \geq 0$ and $b \geq 0$.
[Hint: Observe that G^* has an open subgroup topologically isomorphic to $\mathbb{R}^a \times K_1$, where K_1 is compact and $a \geq 0$. Noting that K_1^* is a quotient

group of G , we see that it must be finitely generated and so K_1 is topologically isomorphic to $\mathbb{T}^b \times F$, where F is a finite discrete group and $b \geq 0$.]

6. Let G be a subgroup of \mathbb{R}^n , $n \geq 1$ and $\Omega(G)$ its annihilator. Show that $\Omega(G) = \{y \in \mathbb{R}^n : (y|x) \text{ is an integer for each } x \in G\}$, where $y = (y_1, \dots, y_n) \in \mathbb{R}^n$, $x = (x_1, \dots, x_n) \in G \subseteq \mathbb{R}^n$ and $(y|x) = \sum_{i=1}^n y_i x_i$.

[Hint: Recall that $\mathbb{T} = \mathbb{R}/\mathbb{Z}$ and use [Examples A5.7.3 \(ii\)](#) and [Theorem A5.9.1](#).]

7. Recall that a topological group G is said to be almost connected if the quotient group G/G_0 is compact, where G_0 is the connected component of the identity element of G . If G is an almost connected LCA-group, show that G is topologically isomorphic to $\mathbb{R}^n \times K$, for some compact group K and $n \geq 0$.

A5.15 Consequences of the Duality Theorem

Part Two: Connected and Totally Disconnected LCA-groups

A5.15.1 Theorem. Let G be an LCA-group and Γ its dual group. Then G is metrizable if and only if Γ is σ -compact.

Proof. Assume that G is metrizable. Then G has a countable base of compact neighbourhoods $U_1, U_2, \dots, U_n, \dots$ of 0. By [Corollary A5.7.7](#), if $a = \frac{1}{5}$, then the sets $\overline{P(U_i, V_a)}$, $i = 1, 2, \dots$, are compact neighbourhoods of 0 in Γ . As each $\gamma \in \Gamma$ is continuous, $\Gamma = \bigcup_{i=1}^{\infty} \overline{P(U_i, V_a)}$. So Γ is σ -compact.

Conversely, assume that Γ is σ -compact. By [Exercises A5.12 #4](#), there exists a family $\{Y_n\}$, $n = 1, 2, \dots$ of compact neighbourhoods of 0 in Γ such that every compact subset of Γ lies in some Y_n and $Y_n \subseteq Y_{n+1}$, $n \geq 1$. So the family $\{g \in G : (g, \gamma) \in V_{1/k}, \text{ for all } \gamma \in Y_n\}$, for $k = 2, 3, \dots$ and $n = 1, 2, \dots$ is a base of neighbourhoods of 0 in G . (Observe that in saying that these sets are neighbourhoods we are using the fact that G is the dual group of Γ .) Thus G has a countable base of neighbourhoods at 0 which, by [Exercises A5.6 #3\(ii\)](#), implies that G is metrizable. □

As a corollary we have the following striking result.

A5.15.2 Corollary. Let G be an LCA-group. Then G is compact and metrizable if and only if its dual group Γ is countable.

Proof. Exercise. □

We now characterize those compact groups which are connected.

A5.15.3 Proposition. Let G be a locally compact Hausdorff group and K a compact subset of G . Then there exists an open and closed compactly generated subgroup of G containing K .

Proof. Exercise. □

A5.5.4 Definition. An element g of a topological group G is said to be **compact** if $\overline{\text{gp}\{g\}}$, the smallest closed subgroup of G containing g , is compact.

A5.15.5 Example. An element $g \in G = \mathbb{R}^a \times \mathbb{Z}^b \times K$, where K is compact and $a \geq 0$ and $b \geq 0$, is compact if and only if it lies in $\{0\} \times \{0\} \times K$. □

A5.15.6 Proposition. If G is an LCA-group, then the set S of compact elements is a closed subgroup of G .

Proof. If g and h are in S , then $g - h \in \text{gp}\{g\} + \text{gp}\{h\} \subseteq \overline{\text{gp}\{g\}} + \overline{\text{gp}\{h\}}$. As $g - h$ lies in the compact group $\overline{\text{gp}\{g\}} + \overline{\text{gp}\{h\}}$, it is compact and so is in S . Thus S is a subgroup of G .

Now let $x \in \overline{S}$. By [Proposition A5.15.3](#) there is an open compactly generated subgroup H of G containing x . By [Theorem A5.13.7](#), H is topologically isomorphic to $\mathbb{R}^a \times \mathbb{Z}^b \times K$, where K is compact, $a \geq 0$ and $b \geq 0$. To see that $x \in S$ we have to show only that the \mathbb{R}^a coordinate of x and the \mathbb{Z}^b coordinate of x are both zero. If the \mathbb{R}^a coordinate of x or the \mathbb{Z}^b coordinate of x were different from zero, then there would be an entire neighbourhood of x disjoint from S —since all compact elements of $\mathbb{R}^a \times \mathbb{Z}^b \times K$ lie in $\{0\} \times \{0\} \times K$. This would contradict the fact that $x \in \overline{S}$. \square

A5.15.7 Remark. The set of compact elements of a non-abelian locally compact Hausdorff group G need not be a subgroup of G . As an example of this, let G be the discrete group generated by two elements a and b with the relations $a^2 = b^2 = e$. Then a and b are compact elements, but ab is not compact. \square

A5.15.8 Theorem. Let G be an LCA-group, Γ its dual group, S the set of compact elements in Γ and C the component of 0 in G . Then S is the annihilator in Γ of C and C is the annihilator in G of S .

Proof.

- (i) Assume that there is a compact subgroup K of Γ such that $K \neq \{0\}$. Then G has a discrete quotient group K^* . As K^* is not connected, G is not connected.
- (ii) Assume that G is totally disconnected. Let $\gamma \in \Gamma$ and U be a neighbourhood of 0 in G such that $\gamma(g) \in V_{1/4}$, for all $g \in U$. As G is locally compact and totally disconnected, [Exercises A5.3 #4\(i\)](#) implies that U contains a compact open subgroup K . It is clear that $\gamma(K)$ is a subgroup of $V_{1/4}$ and hence equals $\{0\}$; that is, $\gamma \in \Lambda(\Gamma, K)$ the annihilator in Γ of K . As K is open in G , $\Lambda(\Gamma, K)$, is compact. So every $\gamma \in \Gamma$ lies in a compact group. Hence $S = \Gamma$.
- (iii) Now let G be any LCA-group. Then G/C is a totally disconnected LCA-group and so, by (ii), the dual group of G/C contains only compact elements. As $(G/C)^*$ is topologically isomorphic to $\Lambda(\Gamma, C)$, we see that $\Lambda(\Gamma, C) \subseteq S$. As C is a connected LCA-group (i) implies that C^* has no nontrivial compact subgroup; that is, $\Gamma/\Lambda(\Gamma, C)$ has no compact subgroup. Suppose $\gamma \in S$ and $\gamma \notin \Lambda(\Gamma, C)$. Then there is a compact subgroup K of Γ whose image under the canonical map $f : \Gamma \rightarrow \Gamma/\Lambda(\Gamma, C)$ is not $\{0\}$. This image is a compact subgroup of $\Gamma/\Lambda(\Gamma, C)$ and so we have a contradiction. Hence $S \subseteq \Lambda(\Gamma, C)$. Thus $S = \Lambda(\Gamma, C)$.

The dual statement then follows from [Proposition A5.14.2](#). □

A5.15.9 Corollary. Let G be an LCA-group. Then G is totally disconnected if and only if every element in G^* is compact. □

A5.15.10 Corollary. Let G be an LCA-group. Then G is connected if and only if G^* has no compact subgroup $\neq \{0\}$. □

A5.15.11 Corollary. Let G be a compact Hausdorff abelian group with C the component of 0 in G . Let Φ be the torsion subgroup of Γ (that is, the subgroup consisting of all elements of finite order). Then $\Phi = \Lambda(\Gamma, C)$, the annihilator in Γ of C , and $C = \Lambda(G, \Phi)$. Also Φ is isomorphic to $(G/C)^*$.

Proof. The first two equalities follow from the [Theorem A5.15.7](#), since an element of a discrete group is compact if and only if it has finite order. The last statement follows from the duality between subgroups and quotient groups. \square

As an immediate consequence of [Corollary A5.15.11](#) we have an interesting characterization of those compact groups which are connected.

A5.15.12 Corollary. A compact Hausdorff abelian group is connected if and only if its dual group is torsion free. \square

Notation. Let G be an abelian group and f_n the homomorphism of G into itself given by $f_n(g) = ng$, for n a positive integer. We denote $f_n(G)$ by $G^{(n)}$ and $f_n^{-1}\{0\}$ by $G_{(n)}$.

A5.15.13 Proposition. Let G be an LCA-group with dual group Γ . For any $n \in \mathbb{N}$,

- (i) $\Lambda(\Gamma, G^{(n)}) = \Gamma_{(n)}$, and
- (ii) $\Lambda(\Gamma, G_{(n)}) = \overline{\Gamma^{(n)}}$.

Proof. Let $\gamma \in \Lambda(\Gamma, G^{(n)})$. Then for each $g \in G$ we have $ng \in G^{(n)}$ and so $\gamma(ng) = n\gamma(g) = 0$. Thus $\gamma \in \Gamma_{(n)}$. Conversely, if $\gamma \in \Gamma_{(n)}$, then $n\gamma(g) = \gamma(ng) = 0$, for all $g \in G$, and so $\gamma \in \Lambda(\Gamma, G^{(n)})$. Hence (i) is true.

To prove (ii) regard G as the dual group of Γ . Then, by (i), $\Lambda(G, \Gamma^{(n)}) = G_{(n)}$ and so $\overline{\Gamma^{(n)}} = \Lambda(\Gamma, \Lambda(G, \overline{\Gamma^{(n)}})) = \Lambda(\Gamma, \Lambda(G, \Gamma^{(n)})) = \Lambda(\Gamma, G_{(n)})$. \square

A5.15.14 Theorem. Let G be an LCA-group and Γ its dual group. If G is divisible, then Γ is torsion-free. If Γ is torsion-free, then $G^{(n)}$ is dense in G , for $n \in \mathbb{N}$. Let G be discrete or compact. Then G is divisible if and only if Γ is torsion-free.

Proof. If G is divisible then $G^{(n)} = G$, for all n and so [Proposition A5.15.13\(i\)](#) implies that $\Gamma_{(n)} = \{0\}$; that is, Γ is torsion-free.

If Γ is torsion-free then [Proposition A5.15.13\(ii\)](#) shows that $\Lambda(G, \Gamma_{(n)}) = G = \overline{G^{(n)}}$, for each $n \in \mathbb{N}$.

If G is discrete then $G^{(n)}$ is certainly closed, for each $n \in \mathbb{N}$. If G is compact then $G^{(n)}$ is a continuous image of G and so is compact and closed. So in both cases $G = G^{(n)}$, for all $n \in \mathbb{N}$, and G is divisible. □

A5.15.15 Corollary. Let G be a compact Hausdorff abelian group and Γ its dual group. Then the following are equivalent:

- (i) G is connected;
- (ii) Γ is torsion-free;
- (iii) G is divisible.

□

A5.15.16 Corollary. Every connected LCA-group G is divisible.

Proof. G is topologically isomorphic to $\mathbb{R}^n \times K$, where K is compact and connected, from which the result immediately follows. □

A5.15.17 Remarks. It is also true that a compact Hausdorff non-abelian group is connected if and only if it is divisible. (See Hofmann and Morris [[191](#)], Theorem 9.35] or Mycielski [[299](#)].)

[Corollary A5.15.16](#) does not extend to the non-abelian case. (See Hewitt and Ross [180, §24.44].) However, it is true that a connected locally compact group is somewhat divisible, where a group G is defined to be **somewhat divisible** if it has subgroups H_1, H_2, \dots, H_n such that each H_i is a divisible group and $G = H_1.H_2.\dots.H_n$. (See Morris [294].) \square

Exercises A5.15

1. Let G be an LCA-group. Show that it is compact and metrizable if and only if its dual group is countable.
[Hint: Use [Corollary A5.4.3](#).]
2. Show that the Bohr-compactification bG of an LCA-group G is metrizable if and only if G is compact and metrizable and $bG = G$.
[Hint: See [Exercises A5.13 #6](#) and use [Exercises A5.15 #1](#) above.]
3. Let K be a compact subset of a locally compact Hausdorff group G . Show that there exists an open and closed compactly generated subgroup of G containing K .
4. Let G be an LCA-group and Γ its dual group. Let a be the least cardinal number of an open basis at 0 in G and b be the least cardinal number of a family of compact subsets of Γ whose union is Γ . Show that $a = b$.
[Hint: To prove $a \leq b$, let $S = \{A_i : i \in I\}$ be a family of compact sets such that $\Gamma = \bigcup_{i \in I} A_i$ and b equals the cardinality of the index set I . Let B_i be an open set containing A_i such that $\overline{B_i}$ is compact, for each $i \in I$. Let S' be the family of all finite unions of sets $\overline{B_{i_1}} \cup \overline{B_{i_2}} \cup \dots \cup \overline{B_{i_n}}$. Verify that Γ is the union of the members of S' and that every compact subset of Γ is a subset of a member of S' . Now proceed as in the proof of [Theorem A5.15.1](#).]
5. (i) Let G be a compact Hausdorff abelian group and $w(G)$ the least cardinal number of an open basis of G . Show that $w(G)$ equals the cardinal number of G^* .
[Hint: Use [Exercises A5.15 #4](#) above.]

- (ii) If G is a compactly generated LCA-group, show that $w(G) = w(G^*)$.
 (iii) If G is any LCA-group, show that $w(G) = w(G^*)$.

[Hint: If G is finite, the result is trivial, so assume G is infinite. Then G has an open subgroup H topologically isomorphic to $\mathbb{R}^n \times K$, where K is compact and $n \geq 0$. Show that

$$w(G) = \max[w(\mathbb{R}^n \times K), \text{cardinal number of } G/H].$$

Observing that G^* has a compact subgroup A , topologically isomorphic to $(G/H)^*$ such that G^*/A is topologically isomorphic to $\mathbb{R}^n \times K^*$, show that

$$w(G^*) \geq \max\{w(\mathbb{R}^n \times K^*), w((G/H)^*)\}.$$

6. Let G be a compact Hausdorff abelian group with dual group Γ . Show that the following conditions are equivalent (where \mathfrak{c} denotes the cardinality of \mathbb{R}).

- (i) G is solenoidal;
 (ii) Γ is algebraically isomorphic to a subgroup of \mathbb{R} ;
 (iii) Γ is torsion-free and the cardinal number of $\Gamma \leq \mathfrak{c}$;
 (iv) G is connected and $w(G) \leq \mathfrak{c}$.

[Hint: See [Exercises A5.13 #4](#). Assume the fact, from abelian group theory, that (iii) implies (ii).]

7. Let G be a divisible compact Hausdorff (not necessarily abelian) group. Prove that G is connected.

[Hint: Suppose that G is not connected and arrive at a contradiction by showing that G has a proper open normal subgroup H , such that G/H is a finite divisible group.]

8. Prove the following statements:

- (i) If groups G_1, G_2, \dots, G_n are somewhat divisible, then the product group $G_1 \times G_2 \cdots \times G_n$ is somewhat divisible.
 (ii) Any quotient group of a somewhat divisible group is somewhat divisible.
 (iii) An abelian group is divisible if and only if it is somewhat divisible.

A5.99 Credit for Images

1. Leon Battista Alberti. Creative Commons License. <https://tinyurl.com/yc9827oh>
2. Harald and Niels Bohr. Public Domain.
3. Filippo Brunelleschi. Creative Commons License <https://tinyurl.com/ya5qp4oh>
4. Élie Cartan. Fair Use. https://en.wikipedia.org/wiki/File:Elie_Cartan.jpg
5. Rudolf Friedrich Alfred Clebsch. Public Domain.
6. Jean Alexandre Eugène Dieudonné. The Mathematisches Forschungsinstitut Oberwolfach gGmbH (MFO) owns the copyright and the photo can be used on the terms of the Creative Commons License Oberwolfach Photo Collection. Photo by Konrad Jacobs of Erlangen. <https://opc.mfo.de/> Fair use. <https://en.wikipedia.org/wiki/File:JeanDieudonné.jpg>
7. Per Enflo. The Mathematisches Forschungsinstitut Oberwolfach gGmbH (MFO) owns the copyright and the photo can be used on the terms of the GNU Free Documentation License. Photo by George M. Bergman. <https://tinyurl.com/y9pnasqm>
8. Per Enflo, Stanisław Mazur, and goose prize. Public Domain.
9. Albert Einstein. Public Domain.
10. Israil Moiseevic Gelfand. The Mathematisches Forschungsinstitut Oberwolfach gGmbH (MFO) owns the copyright and the photo can be used on the terms of the Creative Commons License Oberwolfach Photo Collection. Photo by Konrad Jacobs of Erlangen. <https://opc.mfo.de/> Photo by Konrad Jacobs, Erlangen.
11. Andrew Mattei Gleason. Copyright CC BY-SA 3.0 <https://tinyurl.com/pqyhenr> by <https://tinyurl.com/yb7ahgyh> Notices of the American Mathematical Society, November 2009.
12. Werner Heisenberg. Creative Commons Attribution-Share Alike Germany license. <https://tinyurl.com/y7oyype7>
13. David Hilbert. Public Domain.
14. Karl Hofmann & Sidney Morris at work. Photo owned by author.

15. Hofmann and Morris August 2016. Photo owned by author.
16. Kenkichi Iwasawa. Public Domain.
17. Wilhelm Karl Joseph Killing. Public Domain.
18. Felix Klein. Public Domain.
19. Leopold Kronecker. Public Domain.
20. Richard Kenneth Lashof. Copyright George Bergman. Oberwolfach Photo Collection. GNU Free Documentation License. <https://tinyurl.com/ya2bdnpr>
21. (Marius) Sophus Lie. Public Domain.
22. Carl Louis Ferdinand von Lindemann. Public Domain.
23. Hendrik Antoon Lorentz. Public Domain.
24. Stanisław Mazur. Public Domain.
25. Deane Montgomery. Mathematisches Forschungsinstitut Oberwolfach gGmbH (MFO). Photo by Konrad Jacobs of Erlangen.
26. Julius Plücker. Public Domain.
27. Pierre Laurent Wantzel. Public Domain.
28. Perspective photo. Creative Commons License. <https://tinyurl.com/ygs5g7qh>
29. Lev Semyonovich Pontryagin. Creative Commons Attribution-ShareAlike 3.0 License. Monument to Lev Pontryagin on wall of building on Leninsky Prospekt in Moscow, where he lived from 1939 to 1988. Translation: In this home from 1939 to 1988 lived and worked the great mathematician Lev Semenovich Pontryagin. Author: Anatoly Terentiev. <https://tinyurl.com/yb8qdajo>
30. School of Athens. Public Domain. Copyuright
31. Władysław Hugo Dionizy Steinhaus. Public Domain.
32. Terence Chi-Shen Tao. GNU Free Documentation License. <https://tinyurl.com/yc25cryk>
33. Stanisław Marcin Ulam. Public Domain.

34. Egbert Rudolf van Kampen. Public Domain.
35. Hermann Weyl. ETH-Bibliothek Zürich, Bildarchiv. "This work is free and may be used by anyone for any purpose." <https://tinyurl.com/Hermann-Weyl>
36. Eugene Paul Wigner. Public Domain.
37. Hidehiko Yamabe. Public Domain.
38. Leo Zippin. Copyright Mathematisches Forschungsinstitut Oberwolfach gGmbH (MFO) licensed with CC BY-SA 2.0 de <https://tinyurl.com/pqyhenr>. Photo by Konrad Jacobs.

Appendix 6: Filters and Nets

§A6.0 Introduction	619
§A6.1 Filters	620
§A6.2 Filterbases	640
§A6.3 Nets	649
§A6.4 Wallman Compactifications: An Application of Ultrafilters	659

Introduction³⁶

In the theory of metric spaces, convergent sequences play a key role. This is because they can be used to capture everything about the topology of the metric space. For example, a set S in a metric space (X, d) is closed if and only if every convergent sequence of points in S converges to a point in S . So convergent sequences determine the closed sets, the open sets, the continuous functions and the topological properties. For example, a mapping between metric spaces is continuous if and only if it maps convergent sequences to convergent sequences, and a subset C of a metric space is compact if and only if every sequence consisting of points in C has a subsequence which converges.

However, every metric space (X, d) satisfies the first axiom of countability, that is, every point in X has a countable base of neighbourhoods or, in other words, for each point $a \in X$ there is a countable set of neighbourhoods $U_1, U_2, \dots, U_n, \dots$ such that every neighbourhood of a contains a U_n for some $n \in \mathbb{N}$. [We can choose $U_n = \{x \in X : d(x, a) < \frac{1}{n}\}$, for each $n \in \mathbb{N}$.] However, a general topological space does not necessarily satisfy the first axiom of countability; that is, it need not have a countable base of neighbourhoods for each point. For this reason convergent sequences, which are of course countable sets, do not capture the topology of a general topological space.

Therefore we need a more general concept than convergent sequences which is rich enough to capture the topology of general topological spaces. In this appendix we introduce the notion of a filter. Filters do indeed capture everything about the topology of a general topological space. In particular, we shall see how closedness, continuity, and compactness can be expressed in terms of filters. We shall also see how filters can be used to give an alternative proof of the powerful Tychonoff Theorem.

There is an equivalent, but less elegant, generalization of convergent sequences which uses nets rather than filters. It is interesting to note that filters, which were introduced by Cartan [69, 70] in 1937, have been the preferred approach of many

³⁶Two 14 minute YouTube videos provide a very gentle introduction to this Appendix, and in particular to §6.3. They are:- Topology Without Tears – Sequences and Nets – Video 3a – <http://youtu.be/wXkNgyVg0JE> & Video 3b – <http://youtu.be/xNqLF8GsRFE>.

European (especially, French) mathematicians, while American mathematicians have tended to prefer nets, which were introduced in 1922 by E.H. Moore and H.L. Smith [289]. Bourbaki [51] sum up their philosophy on filters: 'it replaces to advantage the notion of "Moore-Smith convergence"'. Here we treat both filters and nets.

A6.1 Filters

§A6.1 introduces filters and ultrafilters on any non-empty set X . Filters and ultrafilters are then related to the notion of a topology on the set X . It is shown how the property of Hausdorffness can be expressed in terms of filters or ultrafilters. But the magic of ultrafilters, in particular, is demonstrated in an elegant proof of the powerful Tychonoff Theorem for compact spaces.

So we begin with the definition of a filter and find examples. Then we introduce the notion of an ultrafilter and verify that for every filter there is a finer filter which is an ultrafilter. We find a beautiful characterization of ultrafilters amongst all filters.

A6.1.1 Definition. Let X be a set and \mathcal{F} a set of subsets of X . Then \mathcal{F} is said to be a **filter** on X if

- (i) $F_1, F_2 \in \mathcal{F}$ implies $F_1 \cap F_2 \in \mathcal{F}$;
- (ii) $F \in \mathcal{F}$ and $F \subseteq G \subseteq X$ imply $G \in \mathcal{F}$; and
- (iii) $\emptyset \notin \mathcal{F}$.

A6.1.2 Remarks.

- (i) If \mathcal{F} is a filter on a set X , then by Definition A6.1.1(ii), $X \in \mathcal{F}$.
- (ii) If \mathcal{F} is a filter on a set X , then it is not a topology on X .
[This is clear since $\emptyset \notin \mathcal{F}$.]
- (iii) If \mathcal{T} is a topology on a set X , then \mathcal{T} is not a filter on X .
[Again this is clear, since $\emptyset \in \mathcal{T}$.]
- (iv) If \mathcal{F} is a filter on a set X , then $\mathcal{T} = \mathcal{F} \cup \{\emptyset\}$ is a topology on X .
[We see that $X \in \mathcal{T}$, $\emptyset \in \mathcal{T}$, and unions and finite intersections of sets in \mathcal{T} are in \mathcal{T} by Definition A6.1.1 (ii) and Definition A6.1.1(i), respectively. So \mathcal{T} is indeed a topology on X .]
- (v) If \mathcal{T} is a topology on a set X , then $\mathcal{T} \setminus \{\emptyset\}$ is not necessarily a filter on X .
[For example, if \mathcal{T} is the Euclidean topology on \mathbb{R} , then $\mathcal{S} = \mathcal{T} \setminus \{\emptyset\}$ is not a filter since the open interval $(0, 1)$ is a member of \mathcal{S} , while the closed interval $[0, 1]$ is not a member of \mathcal{S} , and so \mathcal{S} does not satisfy Definition A6.1.1(ii).]
- (vi) If \mathcal{F} is a filter on a set X such that $\bigcap_{F_i \in \mathcal{F}} F_i = \emptyset$, then \mathcal{F} is said to be a **free filter**. □

A6.1.3 Examples.

- (i) Let X be any non-empty set and \mathcal{F} consist of just the set X . Then \mathcal{F} is a filter on X .
- (ii) Let X be any non-empty set and S a subset of X . If \mathcal{F} consists of S and all subsets of X which contain S , then \mathcal{F} is a filter on X and is called the **principal filter generated by S** .
- (iii) Let X be an infinite set and $\mathcal{F} = \{F : \emptyset \neq F \subseteq X, X \setminus F \text{ is a finite subset of } X\}$. Then \mathcal{F} is a filter on X and is called the **Fréchet filter**. Every Fréchet filter is a free filter and every free filter contains the Fréchet filter. [Verify this.]
- (iv) Let (X, \mathcal{T}) be a topological space. For each $x \in X$, the set of all neighbourhoods of x is a filter. This filter is known as the **neighbourhood filter**, \mathcal{N}_x , of the point x in (X, \mathcal{T}) . A neighbourhood filter is clearly not a free filter.
- (v) Let f be a mapping of a set X into a set Y and \mathcal{F} a filter on X . Then $f(\mathcal{F})$ is a filter on Y if and only if f is surjective. Further, $f^{-1}(f(\mathcal{F})) = \mathcal{F}$.
[Verify these statements.] □

A6.1.4 Proposition.

- (i) If \mathcal{F} is a filter on a set X , then \mathcal{F} has the finite intersection property; that is, if $F_1, F_2, \dots, F_n \in \mathcal{F}$, $n \in \mathbb{N}$, then $F_1 \cap F_2 \cap \dots \cap F_n \neq \emptyset$;
- (ii) Let \mathcal{S} be a set of subsets of a non-empty set X . There exists a filter \mathcal{F} on X such that $\mathcal{S} \subseteq \mathcal{F}$ if and only if \mathcal{S} has the finite intersection property.

Proof. Part (i) follows from (i) and (iii) of Definition A6.1.1 using mathematical induction.

If \mathcal{F} is a filter containing \mathcal{S} , then it follows from (i) that \mathcal{F} , and hence also \mathcal{S} , has the finite intersection property. Conversely, if \mathcal{S} has the finite intersection property, define

$$\mathcal{F} = \{F : F \subseteq X \text{ such that there exist } S_1, S_2, \dots, S_n \in \mathcal{S}, n \in \mathbb{N} \text{ with } \bigcap_{i=1}^n S_i \subseteq F.\}$$

Clearly \mathcal{F} satisfies Definition A6.1.1 and $\mathcal{S} \subseteq \mathcal{F}$, and so part (ii) is proved. \square

Using Proposition A6.1.4(ii) we introduce the following definition.

A6.1.5 Definition. Let \mathcal{S} be a non-empty set of subsets of a non-empty set X . If \mathcal{S} has the finite intersection property, then the filter

$$\mathcal{F} = \{F : F \subseteq X \text{ such that there exist } S_1, \dots, S_n \in \mathcal{S}, \text{ with } \bigcap_{i=1}^n S_i \subseteq F.\}$$

is said to be the **filter generated by \mathcal{S}** .

A6.1.6 Definitions. Let \mathcal{F}_1 and \mathcal{F}_2 be filters on a set X . Then \mathcal{F}_1 is said to be **finer** than \mathcal{F}_2 , and \mathcal{F}_2 is said to be **coarser** than \mathcal{F}_1 , if $\mathcal{F}_2 \subseteq \mathcal{F}_1$. Further, if $\mathcal{F}_1 \neq \mathcal{F}_2$ also, then \mathcal{F}_1 is said to be **strictly finer** than \mathcal{F}_2 , and \mathcal{F}_2 is said to be **strictly coarser** than \mathcal{F}_1 .

A6.1.7 Remarks.

- (i) Let \mathcal{S} be a non-empty set of subsets of a non-empty set X , where \mathcal{S} has the finite intersection property. Then the filter generated by \mathcal{S} is the coarsest filter on X containing the set \mathcal{S} .
- (ii) Let I be an index set and \mathcal{F}_i , $i \in I$, a non-empty set of filters on a set X . Put $\mathcal{S} = \{F : F \in \mathcal{F}_i, i \in I\}$. If \mathcal{S} has the finite intersection property, then by [Proposition A6.1.4](#),

$$\mathcal{F} = \left\{ F : F \subseteq X \text{ such that there exist } S_1, \dots, S_n \in \mathcal{S}, n \in \mathbb{N}, \text{ with } \bigcap_{i=1}^n S_i \subseteq F. \right\}$$

is the filter generated by \mathcal{S} , and is the coarsest filter containing each of the filters \mathcal{F}_i , $i \in I$. So \mathcal{F} is the coarsest filter that is finer than each \mathcal{F}_i , $i \in I$. \square

A6.1.8 Definition. Let X be a non-empty set and \mathcal{U} a filter on X . Then \mathcal{U} is said to be an **ultrafilter** on X if no filter on X is strictly finer than \mathcal{U} .

A6.1.9 Remark. Let X be a non-empty set and $x_0 \in X$. Let \mathcal{U} be the set of all subsets of X which contain the given element x_0 . Then \mathcal{U} is an ultrafilter. The proof of this is left as an exercise. \square

A6.1.10 Proposition. (Ultrafilter Lemma) If \mathcal{F}_0 is any filter on a set X , then there exists an ultrafilter \mathcal{U} on X such that \mathcal{U} is finer than \mathcal{F}_0 .

Proof. Let \mathbb{F}_0 denote the set of all filters on the set X which are finer than the given filter \mathcal{F}_0 . Noting [Definition 10.2.1](#), we see that we can make \mathbb{F}_0 into a partially ordered set (\mathbb{F}_0, \leq) by putting $\mathcal{F}_i \leq \mathcal{F}_j$, for $\mathcal{F}_i, \mathcal{F}_j \in \mathbb{F}_0$, if $\mathcal{F}_i \subseteq \mathcal{F}_j$. Observe that as $\mathcal{F}_0 \in \mathbb{F}_0$, \mathbb{F}_0 is a non-empty set. We shall now apply [Zorn's Lemma 10.2.16](#).

Let \mathbb{F}_1 be any subset of \mathbb{F}_0 . Then the partial order \leq on \mathbb{F}_0 induces a partial order on \mathbb{F}_1 . If (\mathbb{F}_1, \leq) is a linearly ordered set of filters, then we claim that there is a filter \mathcal{F}_2 which is an upper bound of \mathbb{F}_1 .

Define $\mathcal{F}_2 = \{F : F \in \mathcal{F}_i, \mathcal{F}_i \in \mathbb{F}_1\}$; in other words, \mathcal{F}_2 is the union of all the filters in \mathbb{F}_1 . We will show that \mathcal{F}_2 is a filter by verifying it satisfies [Definition A6.1.1](#). As the empty set, \emptyset , is not a member of any of the filters \mathcal{F}_i in \mathbb{F}_1 , $\emptyset \notin \mathcal{F}_2$. If $F_1, F_2 \in \mathcal{F}_2$, $F_1 \in \mathcal{F}_i \in \mathbb{F}_1$ and $F_2 \in \mathcal{F}_j \in \mathbb{F}_1$. As \mathbb{F}_1 is a linearly ordered set, without loss of generality we can assume $\mathcal{F}_i \leq \mathcal{F}_j$; that is, $\mathcal{F}_i \subseteq \mathcal{F}_j$. So $F_1, F_2 \in \mathcal{F}_j$. As \mathcal{F}_j is a filter, $F_1 \cap F_2 \in \mathcal{F}_j \subseteq \mathcal{F}_2$. Finally, let $F \in \mathcal{F}_2$ and let G be a subset of X containing F . Then $F \in \mathcal{F}_i \in \mathbb{F}_1$. As \mathcal{F}_i is a filter, $G \in \mathcal{F}_i \subseteq \mathcal{F}_2$. So \mathcal{F}_2 is indeed a filter. Clearly \mathcal{F}_2 is an upper bound of \mathbb{F}_1 . Then by [Zorn's Lemma 10.2.16](#), \mathbb{F}_0 has a maximal element, \mathcal{U} .

Suppose \mathcal{F}_3 is a filter on X which is strictly finer than \mathcal{U} . As $\mathcal{U} \in \mathbb{F}_0$, \mathcal{U} is finer than \mathcal{F}_0 . Then \mathcal{F}_3 is also finer than \mathcal{F}_0 . So $\mathcal{F}_3 \in \mathbb{F}_0$. But this contradicts the maximality of \mathcal{U} . So our supposition is false, and no filter is strictly finer than \mathcal{U} . So \mathcal{U} is indeed an ultrafilter and is finer than \mathcal{F}_0 . □

A6.1.11 Remark. As any filter finer than a free filter is a free filter, it follows from the [Ultrafilter Lemma A6.1.10](#) and [Example A6.1.3\(iii\)](#) that free ultrafilters exist. The existence of free ultrafilters is by no means obvious. □

As an immediate consequence of the [Ultrafilter Lemma A6.1.10](#) and [Proposition A6.1.4](#) we have the next corollary which is, in fact, a generalisation of the [Ultrafilter Lemma A6.1.10](#).

A6.1.12 Corollary. If \mathcal{S} is a non-empty set of subsets of a non-empty set X and \mathcal{S} has the finite intersection property, then there is an ultrafilter \mathcal{U} on X such that $\mathcal{S} \subseteq \mathcal{U}$. \square

A6.1.13 Corollary. Let \mathcal{U} be an ultrafilter on a set X . If A and B are subsets of X such that $A \cup B \in \mathcal{U}$, then either $A \in \mathcal{U}$ or $B \in \mathcal{U}$. In particular, if A is any subset of X , then either $A \in \mathcal{U}$ or $X \setminus A \in \mathcal{U}$.

Proof. Suppose there exist $F_1, F_2 \in \mathcal{U}$ such that $F_1 \cap A = \emptyset$ and $F_2 \cap B = \emptyset$, where $A \cup B \in \mathcal{U}$. Then $(F_1 \cap F_2) \cap (A \cup B) = \emptyset$. But this is a contradiction as $F_1 \cap F_2$ and $A \cup B$ are members of the filter \mathcal{U} . So, without loss of generality, assume $F \cap A \neq \emptyset$, for all $F \in \mathcal{U}$.

Let $\mathcal{S} = \mathcal{U} \cup \{A\}$. Then \mathcal{S} has the finite intersection property. By [Corollary A6.1.12](#), there exists an ultrafilter \mathcal{U}_1 such that $\mathcal{U} \subseteq \mathcal{S} \subseteq \mathcal{U}_1$. But this is a contradiction unless $\mathcal{U} = \mathcal{U}_1$, as the ultrafilter \mathcal{U} is maximal. Thus $A \in \mathcal{U}$, which completes the proof. \square

[Corollary A6.1.13](#) suggests a characterization of ultrafilters amongst all filters.

A6.1.14 Proposition. Let \mathcal{F} be a filter on a set X . Then \mathcal{F} is an ultrafilter on X if and only if it has the property that for every subset A of X , either $A \in \mathcal{F}$ or $(X \setminus A) \in \mathcal{F}$.

Proof. If \mathcal{F} is an ultrafilter, then [Corollary A6.1.13](#) shows that for every subset A of X , $A \in \mathcal{F}$ or $X \setminus A \in \mathcal{F}$.

Now assume that for every subset A of X , $A \in \mathcal{F}$ or $(X \setminus A) \in \mathcal{F}$. Suppose \mathcal{F} is not an ultrafilter. Then there exists a filter \mathcal{F}_1 such that $\mathcal{F} \subset \mathcal{F}_1$. So there exists a subset S of X such that $S \in \mathcal{F}_1$ but $S \notin \mathcal{F}$. By our assumption, $(X \setminus S) \in \mathcal{F}$. This implies $(X \setminus S) \in \mathcal{F}_1$. So both S and $X \setminus S$ are members of the filter \mathcal{F}_1 and $S \cap (X \setminus S) = \emptyset$. This is a contradiction to \mathcal{F}_1 being a filter. So our supposition is false, and \mathcal{F} is indeed an ultrafilter. \square

A6.1.15 Corollary. Let \mathcal{U} be an ultrafilter on a set X . Then either $\bigcap_{U_i \in \mathcal{U}} U_i = \emptyset$ or there exists an $x_0 \in X$ such that $\{x_0\} \in \mathcal{U}$ and $\bigcap_{U_i \in \mathcal{U}} U_i = \{x_0\}$.

Proof. Let x be any point in X . By [Proposition A6.1.14](#), either $\{x\} \in \mathcal{U}$ or $(X \setminus \{x\}) \in \mathcal{U}$. If $\{x\} \in \mathcal{U}$, then $\bigcap_{U_i \in \mathcal{U}} U_i \subseteq \{x\}$. So either $\bigcap_{U_i \in \mathcal{U}} U_i = \{x\}$ or \emptyset , as required. On the other hand, if $\{x\} \notin \mathcal{U}$, for all $x \in X$, then $(X \setminus \{x\}) \in \mathcal{U}$, for all $x \in X$. In this case,

$$\bigcap_{U_i \in \mathcal{U}} U_i \subseteq \bigcap_{x \in X} (X \setminus \{x\}) = \emptyset. \quad \square$$

A6.1.16 Corollary. Let f be a mapping of a set X into a set Y and let \mathcal{U} be an ultrafilter on X . Then $f(\mathcal{U})$ is an ultrafilter on Y if and only if f is surjective.

Proof. By [Examples A6.1.3\(v\)](#), $f(\mathcal{U})$ is a filter on Y if and only if f is surjective. So let us assume that f is surjective. We shall prove that $f(\mathcal{U})$ is an ultrafilter using [Proposition A6.1.14](#). So, let A be any subset of Y . As f is surjective,

$$(X \setminus f^{-1}(A)) = f^{-1}(Y \setminus A).$$

Since \mathcal{U} is an ultrafilter, $f^{-1}(A) \in \mathcal{U}$ or $(X \setminus f^{-1}(A)) \in \mathcal{U}$. Thus

$$A \in f(\mathcal{U}) \quad \text{or} \quad f(X \setminus f^{-1}(A)) = f(f^{-1}(Y \setminus A)) = (Y \setminus A) \in f(\mathcal{U}).$$

So $f(\mathcal{U})$ is an ultrafilter by [Proposition A6.1.14](#). □

A6.1.17 Proposition. Let \mathcal{F} be a filter on a set X and let $\mathcal{U}_i, i \in I$, be the set of all ultrafilters on X which are finer than \mathcal{F} . Then $\mathcal{F} = \bigcap_{i \in I} \mathcal{U}_i$.

Proof. For each $i \in I, \mathcal{U}_i \supseteq \mathcal{F}$. So $\bigcap_{i \in I} \mathcal{U}_i \supseteq \mathcal{F}$.

Suppose that there exists a subset S of X , such that $S \notin \mathcal{F}$, but $S \in \mathcal{U}_i$, for each $i \in I$. As each \mathcal{U}_i is a filter, $(X \setminus S) \notin \mathcal{U}_i$, for each $i \in I$. So $(X \setminus S) \notin \mathcal{F}$. Let $\mathcal{F} = \{F_j : j \in J\}$ for some index set J . Either (i) $(X \setminus S) \cap F_j \neq \emptyset$, for each $j \in J$ or (ii) $(X \setminus S) \cap F_j = \emptyset$, for some $j \in J$.

In case (i), $\{F_j : j \in J\} \cup \{X \setminus S\}$ has the finite intersection property. So by Corollary A6.1.12, there exists an ultrafilter \mathcal{U} such that $\mathcal{U} \supseteq (\{F_j : j \in J\} \cup \{X \setminus S\})$; that is, $(X \setminus S) \in \mathcal{U}$ and $\mathcal{F} \subseteq \mathcal{U}$. So $\mathcal{U} = \mathcal{U}_i$ and $(X \setminus S) \in \mathcal{U}_i$, for some $i \in I$. This is a contradiction, and so case (i) cannot occur.

In case (ii), for some $j \in J, (X \setminus S) \cap F_j = \emptyset$ and thus $F_j \subseteq S$. As $F_j \in \mathcal{F}$ and \mathcal{F} is a filter, this implies $S \in \mathcal{F}$. This too is a contradiction, and so case (ii) cannot occur.

Thus our supposition is false; that is, S cannot exist. This says that $\mathcal{F} = \bigcap_{i \in I} \mathcal{U}_i$, as required. \square

A6.1.18 Remark. As an immediate consequence of [Proposition A6.1.17](#) we obtain the following: If \mathcal{F} is a filter on a set X and there exists an ultrafilter \mathcal{U} on X which is strictly finer than \mathcal{F} , then there must exist at least one other ultrafilter (strictly) finer than \mathcal{F} . \square

While filters on sets are interesting, our focus is on topological spaces. So we now examine the interplay between topologies and filters via the notion of convergence.

A6.1.19 Definition. Let (X, \mathcal{T}) be a topological space, $x \in X$, and \mathcal{F} a filter on the set X . Then the filter \mathcal{F} is said to **converge** on (X, \mathcal{T}) to x , and x is said to be a **limit** in (X, \mathcal{T}) of \mathcal{F} , denoted by $x \in \lim \mathcal{F}$ or $\mathcal{F} \rightarrow x$, if each neighbourhood in (X, \mathcal{T}) of x is a member of \mathcal{F} . The set of all limit points in (X, \mathcal{T}) of \mathcal{F} is denoted by $\lim \mathcal{F}$.

A6.1.20 Remark. Let (X, \mathcal{T}) be a topological space and $x \in X$. Then the neighbourhood filter, \mathcal{N}_x of x converges on (X, \mathcal{T}) to x . \square

A6.1.21 Remark. Let (X, \mathcal{T}) be a topological space and $x \in X$. A filter \mathcal{F} on the set X converges to x if and only if \mathcal{F} is finer than the neighbourhood filter, \mathcal{N}_x , of x . [Verify this.] \square

A6.1.22 Proposition. Let (X, \mathcal{T}) be a topological space. Then the following are equivalent:

- (i) (X, \mathcal{T}) is a Hausdorff space;
- (ii) Every filter \mathcal{F} on (X, \mathcal{T}) converges to at most one point;
- (iii) Every ultrafilter \mathcal{U} on (X, \mathcal{T}) converges to at most one point.

Proof. Exercise. \square

A6.1.23 Proposition. Let (X, \mathcal{T}) be a topological space. Then (X, \mathcal{T}) is compact if and only if for every filter \mathcal{F} on (X, \mathcal{T}) there is a filter \mathcal{F}_1 which is finer than \mathcal{F} and converges.

Proof. Recall that, by [Proposition 10.3.2](#), a topological space is compact if and only if for every family \mathcal{S} of closed subsets with the finite intersection property, $\bigcap_{S_i \in \mathcal{S}} S_i \neq \emptyset$.

Assume that (X, \mathcal{T}) is compact and let \mathcal{F} be any filter on (X, \mathcal{T}) . Then \mathcal{F} has the finite intersection property. Put $\mathcal{G} = \{\overline{F} : F \in \mathcal{F}\}$. Then \mathcal{G} has the finite intersection property too. As (X, \mathcal{T}) is compact, there exists a point $x_0 \in X$, such that $x_0 \in \bigcap_{F_i \in \mathcal{F}} \overline{F_i}$. So if $N_{x_0} \in \mathcal{N}_{x_0}$, the neighbourhood filter in (X, \mathcal{T}) of x_0 , then $N_{x_0} \cap F_i \neq \emptyset$, for all $F_i \in \mathcal{F}$. Thus \mathcal{F} and \mathcal{N}_{x_0} are filters on (X, \mathcal{T}) such that $\mathcal{S} = \{S : S \in \mathcal{N}_{x_0} \text{ or } S \in \mathcal{F}\}$ has the finite intersection property.. So by [Remark A6.1.7\(ii\)](#), there exists a filter \mathcal{F}_1 on (X, \mathcal{T}) such that \mathcal{F}_1 is finer than both \mathcal{F} and \mathcal{N}_{x_0} . As \mathcal{F}_1 is finer than the neighbourhood filter \mathcal{N}_{x_0} , [Remark A6.1.21](#) says that $\mathcal{F}_1 \rightarrow x_0$. As the filter \mathcal{F}_1 is also finer than \mathcal{F} , this proves the required result.

Conversely, assume that for every filter on (X, \mathcal{T}) there is a filter which is finer than it which converges. Let \mathcal{S} be a family of closed subsets of (X, \mathcal{T}) with the finite intersection property. By [Proposition A6.1.4 \(ii\)](#), there is a filter \mathcal{F} on (X, \mathcal{T}) which contains \mathcal{S} . So by assumption, there exists a point x_0 in X and a filter $\mathcal{F}_1 \supseteq \mathcal{F}$ such that $\mathcal{F}_1 \rightarrow x_0$. So by [Remark A6.1.21](#), $\mathcal{F}_1 \supseteq \mathcal{N}_{x_0}$, the neighbourhood filter of x_0 . Thus for each $N_{x_0} \in \mathcal{N}_{x_0}$, $N_{x_0} \cap F \neq \emptyset$, for each $F \in \mathcal{F}_1$. In particular, $N_{x_0} \cap S_i \neq \emptyset$, for every $S_i \in \mathcal{S}$. Therefore $x_0 \in \bigcap_{S_i \in \mathcal{S}} S_i$. So (X, \mathcal{T}) is compact. \square

While [Proposition A6.1.23](#) is a nice characterization of compactness using filters, its [Corollary A6.1.24](#) is a surprisingly nice characterization of compactness using ultrafilters.

A6.1.24 Corollary. Let (X, \mathcal{T}) be a topological space. Then (X, \mathcal{T}) is compact if and only if every ultrafilter on (X, \mathcal{T}) converges.

Proof. Let \mathcal{U} be any ultrafilter on (X, \mathcal{T}) . By [Proposition A6.1.23](#), there is a filter $\mathcal{F}_1 \supseteq \mathcal{U}$ which converges. But as \mathcal{U} is an ultrafilter, $\mathcal{U} = \mathcal{F}_1$. So \mathcal{U} converges.

Conversely, assume that every ultrafilter on (X, \mathcal{T}) converges. Let \mathcal{F} be any filter on (X, \mathcal{T}) . Then, by the [Ultrafilter Lemma A6.1.10](#), there is an ultrafilter $\mathcal{U} \supseteq \mathcal{F}$. By assumption \mathcal{U} converges; that is, there is a filter finer than \mathcal{F} which converges, which completes the proof. \square

We now present a proof of [Tychonoff's Theorem 10.3.4](#) using ultrafilters.

A6.1.25 Theorem. (Tychonoff's Theorem) Let $\{(X_i, \mathcal{T}_i) : i \in I\}$ be any family of topological spaces. Then $\prod_{i \in I} (X_i, \mathcal{T}_i)$ is compact if and only if each (X_i, \mathcal{T}_i) is compact.

Proof. If $\prod_{i \in I} (X_i, \mathcal{T}_i)$ is compact, then each (X_i, \mathcal{T}_i) , $i \in I$, is compact as $X_i = p_j(\prod_{i \in I} X_i)$ and a continuous image of a compact space is compact.

Conversely, assume each (X_i, \mathcal{T}_i) , $i \in I$ is compact. Let \mathcal{U} be any ultrafilter on $\prod_{i \in I} (X_i, \mathcal{T}_i)$. By [Corollary A6.1.24](#), it suffices to prove that \mathcal{U} converges.

By [Lemma A6.1.16](#), $p_i(\mathcal{U})$ is an ultrafilter on (X_i, \mathcal{T}_i) , for each $i \in I$. As (X_i, \mathcal{T}_i) is compact, [Corollary A6.1.24](#) implies that $p_i(\mathcal{U})$ converges in (X_i, \mathcal{T}_i) , for each $i \in I$. Noting [Proposition A6.1.22](#), we see that $p_i(\mathcal{U})$ may converge to more than one point if (X_i, \mathcal{T}_i) is not Hausdorff. Using the Axiom of Choice, for each $i \in I$, choose $x_i \in X_i$ such that $p_i(\mathcal{U}) \rightarrow x_i$.

Let O_j be any open neighbourhood in (X_j, \mathcal{T}_j) of x_j . As $p_j(\mathcal{U}) \rightarrow x_j$, $O_j \in p_j(\mathcal{U})$. Since $p_j(\mathcal{U})$ is a filter, $(X_j \setminus O_j) \notin p_j(\mathcal{U})$. Therefore $[(X_j \setminus O_j) \times \prod_{i \in I \setminus \{j\}} X_i] \notin \mathcal{U}$. By [Proposition A6.1.14](#), this implies that $[O_j \times \prod_{i \in I \setminus \{j\}} X_i] \in \mathcal{U}$. By [Definition A6.1.1\(ii\)](#) this implies that if $j_1, j_2, \dots, j_n \in I$, and O_{j_k} is any open neighbourhood in $(X_{j_k}, \mathcal{T}_{j_k})$ of x_{j_k} , $k = 1, 2, \dots, n$, then

$$[O_{j_1} \times O_{j_2} \times \dots \times O_{j_n} \times \prod_{i \in I \setminus \{j_1, \dots, j_n\}} X_i] \in \mathcal{U}.$$

As every neighbourhood, N_x , in $\prod_{i \in I} X_i$ of $x = \prod_{i \in I} x_i$ must contain a basic open set of the form $[O_{j_1} \times O_{j_2} \times \dots \times O_{j_n} \times \prod_{i \in I \setminus \{j_1, \dots, j_n\}} X_i]$, it follows that $N_x \in \mathcal{U}$, because \mathcal{U} is a filter. So $\mathcal{U} \supseteq \mathcal{N}_x$, and hence $\mathcal{U} \rightarrow x$, as required. \square

There are three 15 minute YouTube videos which, together with [Appendix 1](#), would help put [Remark A6.1.26](#) into context. The videos are:- Topology Without Tears – Infinite Set Theory –

Video 2a – <http://youtu.be/9h83ZJeiecg>,

Video 2b – <http://youtu.be/QPSRB4Fhzko>, &

Video 2c – <http://youtu.be/YvqUnjjQ3TQ>

A6.1.26 Remark. It is appropriate for us to say a few words about Set Theory, on which our study of Topology rests. The standard axioms for Set Theory are known as the Zermelo-Fraenkel (ZF) axioms. These are named after the mathematicians, Ernst Zermelo [1871–1953] and Abraham Halevi Fraenkel³⁷ [1891–1965]. In 1904, Zermelo formulated the **Axiom of Choice (AC)**, which says:

For any set $\{X_i : i \in I\}$ of non-empty sets, we can choose a member from each X_i .

More formally this says:

For any set $\{X_i : i \in I\}$ of non-empty sets, there exists a function $f : I \rightarrow \bigcup_{i \in I} X_i$ such that $f(x) \in X_i$ for every $i \in I$.

In language more familiar to readers of this book, we can state the **Axiom of Choice** as follows:

For any set $\{X_i : i \in I\}$ of non-empty sets, $\prod_{i \in I} X_i$ is non-empty.

Zermelo said that the Axiom of Choice is an unobjectionable logical principle. It is known that the Axiom of Choice is not implied by the Zermelo-Fraenkel axioms, but is consistent with them; that is, AC is independent of, but consistent with, ZF. During much of the twentieth century, AC was controversial. Mathematicians were divided on whether AC is true or false or whether it should be assumed [that is, added to the ZF axioms] and used. Jan Mycielski [300] relates an anecdote which

³⁷Fraenkel was the first Dean of Mathematics at the Hebrew University of Jerusalem.

demonstrates this very well:

The mathematician Alfred Tarski (1902–1983) tried to publish his theorem proving the equivalence between AC and “every infinite set A has the same cardinality as the product set $A \times A$ ” in the oldest extant mathematics journal in the world, *Comptes Rendus*, but the mathematicians Maurice René Fréchet (1878–1973) and Henri-Léon Lebesgue (1875–1941) refused to present it. Fréchet wrote that an implication between two well known true propositions is not a new result, and Lebesgue wrote that an implication between two false propositions is of no interest.

In this book we do not hesitate to use the Axiom of Choice. The Axiom of Choice is equivalent to [Zorn's Lemma 10.2.16](#) and to the [Well-Ordering Theorem \[WOT\] 10,2,15](#) (which says that **every set can be well-ordered**). It is also equivalent to Tychonoff's Theorem which says that any product of compact spaces is compact.

However, if you examine the above proof of Tychonoff's Theorem, you will see that the special case of Tychonoff's Theorem which says that any product of compact Hausdorff spaces is compact Hausdorff, does not require the Axiom of Choice but only the Ultrafilter Lemma, as $p_i(\mathcal{U})$ converges to a unique point in a Hausdorff space and so no choice is needed. But we did use Zorn's Lemma in our proof of the [Ultrafilter Lemma](#). While **the Ultrafilter Lemma is implied by the Axiom of Choice**, it is not equivalent to the Axiom of Choice, it is in fact weaker.

In summary, **the following four statements are equivalent to each other: (i) Axiom of Choice (ii) Zorn's Lemma (iii) Well-Ordering Theorem and (iv) Tychonoff's Theorem. Each of these implies, but is not implied by, the Ultrafilter Lemma.** Further, none of these is implied by the Zermelo-Fraenkel axioms. For deeper discussion of the Axiom of Choice, see Rubin and Rubin [348], Rubin and Rubin [349] and Herrlich [176]. [The book Howard and Rubin [199] is a survey of research done during the last 100 years on the Axiom of Choice and its consequences, and is updated on Howard [198].] □

A6.1.27 Proposition. Let f be a surjective mapping of a topological space (X, \mathcal{T}) onto a topological space (Y, \mathcal{T}_1) , and for each $x \in X$, let \mathcal{N}_x and $\mathcal{N}_{f(x)}$ denote, respectively, the filter of neighbourhoods of $x \in (X, \mathcal{T})$ and the filter of neighbourhoods of $f(x) \in (Y, \mathcal{T}_1)$. Then the following are equivalent:

- (i) f is continuous;
- (ii) for every $x \in X$, $N_{f(x)} \in \mathcal{N}_{f(x)} \implies f^{-1}(N_{f(x)}) \in \mathcal{N}_x$;
- (iii) for every $x \in X$, $f(\mathcal{N}_x) \supseteq \mathcal{N}_{f(x)}$;
- (iv) for every $x \in X$ and every filter \mathcal{F} on (X, \mathcal{T}) , $\mathcal{F} \rightarrow x \implies f(\mathcal{F}) \rightarrow f(x)$;
that is, $\mathcal{F} \supseteq \mathcal{N}_x \implies f(\mathcal{F}) \supseteq \mathcal{N}_{f(x)}$;
- (v) for every $x \in X$ and every ultrafilter \mathcal{U} on (X, \mathcal{T}) , $\mathcal{U} \rightarrow x \implies f(\mathcal{U}) \rightarrow f(x)$;
that is, $\mathcal{U} \supseteq \mathcal{N}_x \implies f(\mathcal{U}) \supseteq \mathcal{N}_{f(x)}$.

Proof. We begin by noting that [Remark A6.1.21](#) says that a filter \mathcal{F} converges to a point x if and only if \mathcal{F} is finer than \mathcal{N}_x .

Clearly (i) \Leftrightarrow (ii) \Leftrightarrow (iii) and (iii) \implies (iv) \implies (v).

We shall complete the proof of the Proposition by showing that (v) \implies (ii). Assume (v) is true. Let $x \in X$ and \mathcal{U} be any ultrafilter finer than \mathcal{N}_x . Let $N_{f(x)} \in \mathcal{N}_{f(x)}$. Then $N_{f(x)} \in f(\mathcal{U})$. By [Examples A6.1.13\(v\)](#), $f^{-1}(N_{f(x)}) \in \mathcal{U}$. By [Proposition A6.1.17](#), \mathcal{N}_x equals the intersection of all ultrafilters containing it. As $f^{-1}(N_{f(x)})$ is in each such ultrafilter, $f^{-1}(N_{f(x)}) \in \mathcal{N}_x$. Thus (v) \implies (ii). \square

The same kind of argument used above yields the next Proposition.

A6.1.28 Proposition. Let (X, \mathcal{T}) be a topological space and O a subset of X . If \mathcal{N}_x denotes the neighbourhood filter of any point $x \in X$, then the following are equivalent:

- (i) O is an open set in (X, \mathcal{T}) ;
- (ii) for every $x \in O$, there exists an $N_x \in \mathcal{N}_x$ such that $N_x \subseteq O$;
- (iii) for every $x \in O$, $O \in \mathcal{N}_x$;
- (iv) for every $x \in O$, and every filter $\mathcal{F}_x \rightarrow x$, $O \in \mathcal{F}_x$;
- (v) for every $x \in O$, and every ultrafilter $\mathcal{U}_x \rightarrow x$, $O \in \mathcal{U}_x$.

Proof. Exercise. □

The next corollary follows immediately.

A6.1.29 Corollary. Let (X, \mathcal{T}) be a topological space and C a subset of X . If \mathcal{N}_x denotes the neighbourhood filter of any point $x \in X$, then the following are equivalent:

- (i) C is a closed set in (X, \mathcal{T}) ;
- (ii) for every $x \in (X \setminus C)$, there exists an $N_x \in \mathcal{N}_x$ such that $N_x \subseteq (X \setminus C)$;
- (iii) for every $x \in (X \setminus C)$, $(X \setminus C) \in \mathcal{N}_x$;
- (iv) for every $x \in (X \setminus C)$, and every filter $\mathcal{F}_x \rightarrow x$, $(X \setminus C) \in \mathcal{F}_x$;
- (v) for every $x \in (X \setminus C)$, and every ultrafilter $\mathcal{U}_x \rightarrow x$, $(X \setminus C) \in \mathcal{U}_x$. □

A6.1.30 Proposition. Let X be a non-empty set and for each $x \in X$, let \mathcal{S}_x be a non-empty set of filters on X such that $x \in \mathcal{F}_{xi}$, for each $\mathcal{F}_{xi} \in \mathcal{S}_x$. Let \mathcal{T} be the set of subsets of X defined as follows:

$$O \in \mathcal{T} \text{ if for each } x \in O, O \in \mathcal{F}_{xi}, \text{ for every filter } \mathcal{F}_{xi} \in \mathcal{S}_x.$$

Then \mathcal{T} is a topology on X .

Further, for each $x \in X$ and each filter $\mathcal{F}_{xi} \in \mathcal{S}_x$, $\mathcal{F}_{xi} \rightarrow x$ in (X, \mathcal{T}) and $\mathcal{N}_x = \bigcap_{\mathcal{F}_{xi} \in \mathcal{S}_x} \mathcal{F}_{xi}$ is the neighbourhood filter at x in (X, \mathcal{T}) .

Proof. Exercise. □

A6.1.31 Corollary. Let X be a non-empty set and \mathcal{T}_1 a topology on the set X . Further let \mathcal{S}_x be the set of all ultrafilters which converge to x on (X, \mathcal{T}_1) . Let \mathcal{T} be the topology defined from \mathcal{S}_x , $x \in X$, as in Proposition A6.1.30. Then $\mathcal{T} = \mathcal{T}_1$.

Proof. Exercise. □

A6.1.32 Remark. We have now seen that a topology \mathcal{T} on a set X determines convergent filters and convergent ultrafilters, and conversely a set of filters or ultrafilters determines a topology. We have also seen how filters or ultrafilters can be used to define continuous functions and compactness. And we have seen that ultrafilters can be used to give an elegant and short proof of [Tychonoff's Theorem](#). □

Exercises A6.1

1. Find all filters on each of the following sets: (i) $\{1, 2\}$; (ii) $\{1, 2, 3\}$; and (iii) $\{1, 2, 3, 4\}$.
2. Let X be a set and for some index set I , let $\{\mathcal{F}_i : i \in I\}$ be filters on the set X . Prove the following statements:
 - (i) $\mathcal{F} = \bigcap_{i \in I} \mathcal{F}_i$ is a filter on the set X ; that is, **the intersection of any (finite or infinite) number of filters on a set X is a filter**;
 - (ii) $\mathcal{F} = \bigcap_{i \in I} \mathcal{F}_i = \left\{ \bigcup_{i \in I} F_i : F_i \in \mathcal{F}_i \right\}$
 [Hint: This curious looking fact follows from the fact that each \mathcal{F}_i is a filter.]
3. Verify that a filter \mathcal{F} on a finite set is not a free filter.
4. Prove the statements in [Examples A6.1.3 \(iii\) and \(v\)](#).
5. Let X be a set with at least two points, \mathcal{T} a topology on X other than the indiscrete topology, and $\mathcal{F} = \mathcal{T} \setminus \{\emptyset\}$. If \mathcal{F} is a filter, then (X, \mathcal{T}) is
 - (i) connected;
 - (ii) extremally disconnected (that is, the closure of every open set is open);
 - (iii) not metrizable;
 - (iv) not Hausdorff; and
 - (v) not a regular space.
6. Let \mathcal{F} be a filter on a set X such that for some $F \in \mathcal{F}$, $F \neq X$. If $x_0 \in X$ but $x_0 \notin F$, show that the set $X \setminus \{x_0\} \in \mathcal{F}$. Using this, prove that every free filter on a set X is finer than the Fréchet filter on X .
7. Let $\mathcal{S} = \{\mathbb{N} \setminus \{n\} : n \in \mathbb{N}\}$. Find the filter on \mathbb{N} which is generated by \mathcal{S} .
8. (i) Let X be a set and \mathcal{G} a family of subsets of X . Prove that there exists a filter \mathcal{F} such that $\mathcal{F} \supseteq \mathcal{G}$ if and only if \mathcal{G} has the finite intersection property.

- (ii) If \mathcal{G} is a set of subsets of X and \mathcal{G} has the finite intersection property, prove that the filter generated by \mathcal{G} is the coarsest filter \mathcal{F} which contains \mathcal{G} .
9. Let S be a subset of a set X and \mathcal{F} be a filter on X . Find a necessary and sufficient condition for $\mathcal{F}_1 = \{F \cap S : F \in \mathcal{F}\}$ to be a filter on the set S .
10. Find all ultrafilters on each of the following sets: (i) $\{1, 2\}$; (ii) $\{1, 2, 3\}$; and (iii) $\{1, 2, 3, 4\}$.
11. Prove the statement in [Remark A6.1.9](#).
12. Let \mathcal{F} be an ultrafilter on a set X . If A and B are subsets of X we have seen that $A \cup B \in \mathcal{F}$ implies that $A \in \mathcal{F}$ or $B \in \mathcal{F}$. Extend this result in a natural way to sets A_1, A_2, \dots, A_n where $A_1 \cup A_2 \cup \dots \cup A_n \in \mathcal{F}$.
13. Prove the statement in [Remark A6.1.21](#).
14. Prove the statements in [Proposition A6.1.22](#).
15. Prove the statements in [Proposition A6.1.28](#).
16. Let (X, \mathcal{T}) be a topological space, $x \in X$ and S a subset of X . Prove that x is a limit point of S if and only if $S \setminus \{x\}$ is a member of some filter \mathcal{F} which converges to x .

17. Let (X, \mathcal{T}) be a topological space. Prove the following statements:
- (i) (X, \mathcal{T}) is a T_0 -space if and only if for each $x, y \in X$, such that $x \neq y$, there exists a filter \mathcal{F}_{xy} on (X, \mathcal{T}) such that either $x \in \lim \mathcal{F}_{xy}$ and $y \notin \lim \mathcal{F}_{xy}$ or $y \in \lim \mathcal{F}_{xy}$ and $x \notin \lim \mathcal{F}_{xy}$;
 - (ii) (X, \mathcal{T}) is a T_1 -space if and only if for each $x, y \in X$, such that $x \neq y$, there exists filters \mathcal{F}_{xy} and \mathcal{F}_{yx} on (X, \mathcal{T}) such that (a) $x \in \lim \mathcal{F}_{xy}$ and $y \notin \lim \mathcal{F}_{xy}$ and (b) $y \in \lim \mathcal{F}_{yx}$ and $x \notin \lim \mathcal{F}_{yx}$;
 - (iii)* (X, \mathcal{T}) is a Hausdorff space if and only if each filter \mathcal{F} on (X, \mathcal{T}) has at most one limit point.
 [Hint. If (X, \mathcal{T}) is not a Hausdorff space, let $x, y \in X$ be such that $x \neq y$ but each open neighbourhood of x intersects each open neighbourhood of y . Let \mathcal{F}_{xy} consist of all the subsets of X which contain sets of the form $N_x \cap N_y$, for some neighbourhood N_x of x and neighbourhood N_y of y . Show that \mathcal{F}_{xy} is a filter on (X, \mathcal{T}) , $x \in \lim \mathcal{F}_{xy}$ and $y \in \lim \mathcal{F}_{xy}$. So \mathcal{F}_{xy} has more than one limit point. Conversely, let (X, \mathcal{T}) be a Hausdorff space and $x, y \in X$ with $x \neq y$. Then there exists neighbourhoods N_x and N_y of x and y , respectively, such that $N_x \cap N_y = \emptyset$. Note that N_x and N_y cannot both be members of any filter.]
18. Let \mathcal{T}_1 and \mathcal{T}_2 be topologies on a set X . Prove that the topology \mathcal{T}_1 is finer than the topology \mathcal{T}_2 if and only if every convergent filter on (X, \mathcal{T}_1) also converges to the same point(s) on (X, \mathcal{T}_2) .
19. For each i in an index set I , let (X_i, \mathcal{T}_i) be a topological space and let $(X, \mathcal{T}) = \prod_{i \in I} (X_i, \mathcal{T}_i)$, their product space with the product topology. Let p_i be the projection mapping of (X, \mathcal{T}) onto (X_i, \mathcal{T}_i) , for each $i \in I$. Further, let \mathcal{F} be a filter on (X, \mathcal{T}) . Prove that the filter \mathcal{F} converges to a point $x \in X$ if and only if the filter $p_i(\mathcal{F})$ converges to $p_i(x)$ in (X_i, \mathcal{T}_i) , for each $i \in I$.
20. Prove the statements in [Proposition A6.1.30](#).
21. Prove the statement in [Proposition A6.1.31](#).

A6.2 Filterbases

We have seen that it is often more convenient to describe a basis for a topology than the topology itself. For example in \mathbb{R} , \mathbb{R}^n for $n > 1$, metric space topologies, and product topologies there are elegant descriptions of their bases but less than elegant descriptions of the topologies themselves. Similarly, it is often more convenient to describe a filter basis than the filter itself. Further, we will see that it is easy to relate convergent filter bases to convergent sequences.

A6.2.1 Definition. Let X be a non-empty set and \mathcal{G} a set of non-empty subsets of X . Then \mathcal{G} is said to be a **filterbase** (or a **filter basis** or a **filterbasis** or a **filter base**) if $G_1, G_2 \in \mathcal{G}$ implies that there exists a $G_3 \in \mathcal{G}$ such that $G_3 \subseteq G_1 \cap G_2$.

A6.2.2 Remarks. Let X be a non-empty set and \mathcal{G} a filterbase on X . Then

- (i) clearly $\emptyset \notin \mathcal{G}$;
- (ii) every filter on X is also a filterbase on X ;
- (iii) \mathcal{G} has the finite intersection property;
- (iv) the set $\mathcal{F} = \{F \subseteq X : F \supseteq G, G \in \mathcal{G}\}$ is a filter, indeed it is the coarsest filter, containing \mathcal{G} and it is called **the filter generated by \mathcal{G}** ;
- (v) if X is a set and $x \in X$, then $\mathcal{G} = \{x\}$ is a filterbase on X ;
- (vi) if X has more than one point, then $\mathcal{F} = \{\{x\} : x \in X\}$ is not a filterbase or a filter. Indeed, if x and y are distinct points of X , then a filter or filterbasis \mathcal{F} cannot contain both of the sets $\{x\}$ and $\{y\}$.
- (vii) If \mathcal{A} is a set of non-empty subsets of X and \mathcal{A} has the finite intersection property, then there exists a filterbase containing \mathcal{A} . [Verify this.] □

A6.2.3 Examples.

- (i) Let (X, \mathcal{T}) be a topological space and x any point in X . Let \mathcal{N}_x be the set of all neighbourhoods of x in (X, \mathcal{T}) . Then \mathcal{N}_x is clearly a filterbase. It is the **neighbourhood filterbase** of x .
- (ii) Let $[0,1]$ be the closed unit interval with the Euclidean topology. Let $\mathcal{N} = \{[0, 1/n) : n \in \mathbb{N}\}$. Then \mathcal{N} is a filterbase of open neighbourhoods of the point 0.
- (iii) Let X be a set and $x_i, i \in \mathbb{N}$, a sequence of points in X . For each $n \in \mathbb{N}$, let

$$G_n = \{x_j : j \in \mathbb{N} \text{ and } j \geq n\}.$$

So each G_n is a subset of X and we define $\mathcal{G} = \{G_n : n \in \mathbb{N}\}$. Then \mathcal{G} is a filterbase on the set X . We call \mathcal{G} the **filterbase determined by the sequence** $x_i, i \in \mathbb{N}$. □

A6.2.4 Definitions. Let \mathcal{G}_1 and \mathcal{G}_2 be filterbases on a set X . Then (i) \mathcal{G}_1 is said to be **finer** than \mathcal{G}_2 , (ii) \mathcal{G}_2 is said to be **coarser** than \mathcal{G}_1 , and (iii) \mathcal{G}_1 is said to be a **refinement** of \mathcal{G}_2 if for each set $G_2 \in \mathcal{G}_2$, there exists a $G_1 \in \mathcal{G}_1$ such that $G_1 \subseteq G_2$. If \mathcal{G}_1 is both coarser and finer than \mathcal{G}_2 , then \mathcal{G}_1 and \mathcal{G}_2 are said to be **equivalent filterbases**.

A6.2.5 Example. Let $[0,1]$ be the closed unit interval with the Euclidean topology. Let $\mathcal{G}_1 = \{[0, \frac{1}{2n}) : n \in \mathbb{N}\}$ and $\mathcal{G}_2 = \{[0, \frac{1}{2n+1}) : n \in \mathbb{N}\}$. Then \mathcal{G}_1 and \mathcal{G}_2 are easily seen to be equivalent filterbases. □

6.2.6 Example. Consider the sequence $1, \frac{1}{2}, \frac{1}{3}, \dots, \frac{1}{n}, \dots$, and let \mathcal{G}_1 be the filterbase determined by this sequence as in Example 6.2.3 (iii); that is, $\mathcal{G}_1 = \{G_{1n} : n \in \mathbb{N}\}$, where $G_{1n} = \{\frac{1}{n}, \frac{1}{n+1}, \frac{1}{n+2}, \dots\}$. Let \mathcal{G}_2 be the filterbase determined by the sequence $1, \frac{1}{3}, \frac{1}{6}, \frac{1}{9}, \dots, \frac{1}{3n}, \dots$. So $\mathcal{G}_2 = \{G_{2n} : n \in \mathbb{N}\}$, where $G_{2n} = \{\frac{1}{3n}, \frac{1}{3(n+1)}, \frac{1}{3(n+2)}, \dots\}$. Then each $G_{2n} \subset G_{1n}$ and so \mathcal{G}_2 is a refinement of \mathcal{G}_1 . □

A6.2.7 Definition. Let (X, \mathcal{T}) be a topological space and \mathcal{G} a filterbase on X . If $x \in X$, then \mathcal{G} is said to **converge** to x , denoted by $\mathcal{G} \rightarrow x$ and x is said to be a **limit point** of the filterbase \mathcal{G} , denoted by $x \in \lim \mathcal{G}$, if for every neighbourhood U of x there is a $G \in \mathcal{G}$ such that $G \subseteq U$.

A6.2.8 Example. On the Euclidean space \mathbb{R} consider the sequence $1, \frac{1}{2}, \frac{1}{3}, \dots, \frac{1}{n}, \dots$, where $n \in \mathbb{N}$. Let \mathcal{G} be the filterbase determined by this sequence, as in [Example A6.2.3\(iii\)](#). Then clearly $\mathcal{G} \rightarrow 0$. □

A6.2.9 Example. Let (X, \mathcal{T}) be any topological space and x any point in X . Let \mathcal{N}_x be the set of all neighbourhoods of x in (X, \mathcal{T}) ; that is, \mathcal{N}_x is the neighbourhood filterbase at x of [Example A6.2.3\(i\)](#). Clearly $\mathcal{N}_x \rightarrow x$ □

A6.2.10 Remark. Let (X, \mathcal{T}) be a topological space and let \mathcal{G}_1 and \mathcal{G}_2 be filterbases on X . Further let a be a point in X and \mathcal{G}_1 a refinement of \mathcal{G}_2 . If $\mathcal{G}_2 \rightarrow a$, then clearly $\mathcal{G}_1 \rightarrow a$. □

A6.2.11 Proposition. Let (X, \mathcal{T}) be a topological space, S a subset of X , and a a point in $X \setminus S$. Then a is a limit point of the set S if and only if there exists a filterbase \mathcal{F} such that $\mathcal{F} \rightarrow a$ in (X, \mathcal{T}) where each $F \in \mathcal{F}$ satisfies $F \subseteq S$.

Proof. If a is a limit point of S , then each neighbourhood N of a must intersect the set S nontrivially. Let $F_N = N \cap S$. Let \mathcal{N} denote the filterbase of neighbourhoods in (X, \mathcal{T}) of a . We claim that $\mathcal{F} = \{F_N : N \in \mathcal{N}\}$ is a filterbase.

Each F_N is non-empty. Further if $N_1, N_2 \in \mathcal{N}$, then the set $N_3 = N_1 \cap N_2 \in \mathcal{N}$. But then as a is a limit point of S and N_3 is a neighbourhood of a , we also have $F_{N_3} = N_3 \cap S \neq \emptyset$ and $F_{N_3} = N_3 \cap S = (N_1 \cap N_2) \cap S = F_{N_1} \cap F_{N_2}$, and so \mathcal{F} is indeed a filterbase. Further, from the very definition of \mathcal{F} , we see that $\mathcal{F} \rightarrow a$, as required.

Conversely, let \mathcal{F}_1 be a filterbase such that $\mathcal{F}_1 \rightarrow a' \in X$, and each $F \in \mathcal{F}_1$, satisfies $F \subseteq S$. Let N' be any neighbourhood of a' . As $\mathcal{F}_1 \rightarrow a'$, this implies that $N' \supseteq F_1$, for some $F_1 \in \mathcal{F}_1$. Since $F_1 \in \mathcal{F}_1$, $F_1 \subseteq S$, and thus $N' \cap S \neq \emptyset$. Hence a' is a limit point of S , as required. \square

A6.2.12 Corollary. Let (X, \mathcal{T}) be a topological space and S a subset of X . The following two properties are equivalent:

- (i) S is a closed set in (X, \mathcal{T}) ;
- (ii) Let \mathcal{F} be a filterbase on (X, \mathcal{T}) such that $F \in \mathcal{F}$ implies $F \subseteq S$. Further, let $a \in X$ be such that $\mathcal{F} \rightarrow a$. Then $a \in S$ for every such \mathcal{F} and a . \square

A6.2.13 Remark. We know that if (X, \mathcal{T}) is a metrizable topological space, then a subset S of X is closed if and only if each point a in X such that a is a limit point of a sequence $s_1, s_2, \dots, s_n, \dots$ where each $s_n \in S$, satisfies $a \in S$. Noting [Example A6.2.3](#) which says that each sequence determines a filterbase, we see that [Corollary A6.2.12](#) is a generalization of this metrizable space result to arbitrary topological spaces; that is, filterbases for arbitrary topological spaces fulfil the same role that sequences do for metrizable spaces. \square

A6.2.14 Proposition. Let \mathcal{G} be a filterbase on the topological space (X, \mathcal{T}) and $a \in X$. Further, let \mathcal{F} be the filter generated by the filterbase \mathcal{G} . Then $a \in \lim \mathcal{G}$ if and only if $a \in \lim \mathcal{F}$.

Proof. Exercise. \square

A6.2.15 Definition. Let (X, \mathcal{T}) be a topological space and \mathcal{G} a filterbase on X . A point $x \in X$ is said to be a **cluster point of the filterbase**, \mathcal{G} , if for each $G \in \mathcal{G}$ and each neighbourhood U of x , $G \cap U \neq \emptyset$.

A6.2.16 Remarks.

- (i) Every limit point of a filterbase is a cluster point of that filterbase.
- (ii) Consider the sequence $0, 1, 0, 2, 0, 3, \dots, 0, n, \dots$, where $n \in \mathbb{N}$, in the Euclidean space \mathbb{R} . Let \mathcal{G} be the filterbase determined by this sequence as in Example A6.2.3 (iii). Then 0 is clearly a cluster point of \mathcal{G} , but 0 is not a limit point of \mathcal{G} . (Exercise: Verify this.) \square

A6.2.17 Proposition. Let (X, \mathcal{T}) be a topological space, a a point in X , and \mathcal{G} a filterbase on (X, \mathcal{T}) . If \mathcal{G} has a as a cluster point, then there is a filterbase \mathcal{G}_1 on (X, \mathcal{T}) such that \mathcal{G}_1 is a refinement of \mathcal{G} and a is a limit point of \mathcal{G}_1 .

Proof. For each neighbourhood U of a and each $G \in \mathcal{G}$, let $G_U = G \cap U$. Define the set $\mathcal{G}_1 = \{G_U : U \text{ a neighbourhood of } a, G \in \mathcal{G}\}$.

Firstly we have to verify that \mathcal{G}_1 is a filterbase. Let G_1 and G_2 be in \mathcal{G}_1 . Then $G_1 = G'_1 \cap U_1$ and $G_2 = G'_2 \cap U_2$, where U_1 and U_2 are neighbourhoods of a in (X, \mathcal{T}) , and G'_1 and G'_2 are in \mathcal{G} . Then

$$G_1 \cap G_2 = (G'_1 \cap U_1) \cap (G'_2 \cap U_2) = (G'_1 \cap G'_2) \cap (U_1 \cap U_2).$$

As \mathcal{G} is a filterbase, there exists a $G'_3 \in \mathcal{G}$ such that $G'_3 \subseteq G'_1 \cap G'_2$. Since U_1 and U_2 are neighbourhoods of a , $U_3 = U_1 \cap U_2$ is also a neighbourhood of a . As $G'_3 \in \mathcal{G}$, $G'_3 \cap U_3 \in \mathcal{G}_1$. Thus $G_1 \cap G_2$ contains the set $G'_3 \cap U_3$, which is in \mathcal{G}_1 . So \mathcal{G}_1 is indeed a filterbase.

By the definition of \mathcal{G}_1 , it is a refinement of \mathcal{G} .

Clearly, also by the definition of \mathcal{G}_1 , $\mathcal{G}_1 \rightarrow a$; that is a is a limit point of \mathcal{G}_1 . \square

A6.2.18 Proposition. Let (X, \mathcal{T}) be a topological space, a a point in X , and \mathcal{G} a filterbase on (X, \mathcal{T}) . If \mathcal{G}_1 is a filterbase which is a refinement of \mathcal{G} and a is a cluster point of \mathcal{G}_1 , then a is a cluster point of \mathcal{G} .

Proof. To prove that a is a cluster point of \mathcal{G} , let $G \in \mathcal{G}$ and let U be any neighbourhood of a in (X, \mathcal{T}) . We need to show that $G \cap U \neq \emptyset$.

As \mathcal{G}_1 is a refinement of \mathcal{G} , there exists a $G_1 \in \mathcal{G}_1$ such that $G_1 \subseteq G$.

Now a is a cluster point of \mathcal{G}_1 implies that $G_1 \cap U \neq \emptyset$. So $G \cap U \supseteq G_1 \cap U \neq \emptyset$, as required. \square

A6.2.19 Corollary. Let (X, \mathcal{T}) be a topological space, a a point in X , and \mathcal{G} a filterbase on (X, \mathcal{T}) . Then a is a cluster point of \mathcal{G} if and only if there is a filterbase \mathcal{G}_1 which is a refinement of \mathcal{G} such that a is a limit point of \mathcal{G}_1 .

Proof. This is an immediate consequence of [Propositions A6.2.17](#), [A6.2.18](#) and [Remark A6.2.16\(i\)](#). \square

We now show that filterbases can be used to characterize compact topological spaces.

A6.2.20 Proposition. A topological space (X, \mathcal{T}) is compact if and only if every filterbase on (X, \mathcal{T}) has a cluster point.

Proof. Firstly assume that (X, \mathcal{T}) is a compact space and \mathcal{G} is a filterbase on (X, \mathcal{T}) . Then the set $\mathcal{G} = \{G \in \mathcal{G}\}$ has the finite intersection property by [Remarks A6.2.2\(iii\)](#). Therefore the set $\{\overline{G} : G \in \mathcal{G}\}$ of closed sets also has the finite intersection property. As (X, \mathcal{T}) is compact, [Proposition 10.3.2](#) implies that there exists a point $a \in \bigcap_{G \in \mathcal{G}} \overline{G}$. So if U is any neighbourhood of a , $U \cap G \neq \emptyset$. Thus we see that a is a cluster point of the filterbase \mathcal{G} .

To prove the converse, let (X, \mathcal{T}) be a topological space for which every filterbase has a cluster point. We shall prove compactness using [Proposition 10.3.2](#). Let \mathcal{S} be any set of closed subsets of (X, \mathcal{T}) such that \mathcal{S} has the finite intersection property. We shall prove that $\bigcap_{S \in \mathcal{S}} S \neq \emptyset$.

Define \mathcal{A} to be the set of all finite intersections of members of \mathcal{S} . It suffices to prove that $\bigcap_{A \in \mathcal{A}} A \neq \emptyset$.

Now by [Remark A6.2.2\(vii\)](#), \mathcal{A} is a filterbase. So by our assumption, there exists a cluster point x of the filterbase \mathcal{A} ; that is, if V is any neighbourhood of x , then $V \cap A \neq \emptyset$, for each $A \in \mathcal{A}$. This implies that x is a limit point of the set A . Noting that each $A \in \mathcal{A}$, being a finite intersection of closed sets, is a closed set, this implies that $x \in A$, for each $A \in \mathcal{A}$. Hence $\bigcap_{A \in \mathcal{A}} A \neq \emptyset$, as required.

A6.2.21 Corollary. A topological space (X, \mathcal{T}) is compact if and only if every filterbase on (X, \mathcal{T}) has a refinement which has a limit point. \square

Next we show that filterbases can be used to characterize continuous mappings.

A6.2.22 Proposition. Let (X, \mathcal{T}) and (Y, \mathcal{T}_1) be topological spaces and f a continuous mapping of (X, \mathcal{T}) into (Y, \mathcal{T}_1) . If \mathcal{F} is a filterbase on (X, \mathcal{T}) , then $f(\mathcal{F})$ is a filterbase on (Y, \mathcal{T}_1) . Further, if $x \in X$ and $\mathcal{F} \rightarrow x$, then $f(\mathcal{F}) \rightarrow f(x)$.

Proof. Firstly we show that $f(\mathcal{F})$ is a filterbase on (Y, \mathcal{T}_1) . As \mathcal{F} is a filterbase, every set in \mathcal{F} is non-empty and so each set $f(\mathcal{F})$ is also non-empty. Now let $G_1, G_2 \in f(\mathcal{F})$. Then there exists $F_1, F_2 \in \mathcal{F}$ such that $f(F_1) = G_1$ and $f(F_2) = G_2$. As \mathcal{F} is a filterbase, by [Definition A6.2.1](#) there exists a non-empty set $F_3 \in \mathcal{F}$, such that $F_3 \subseteq F_1 \cap F_2$. This implies $f(F_3) \subseteq f(F_1) \cap f(F_2)$; that is, the set $G_3 = f(F_3) \in f(\mathcal{F})$ and $G_3 \subseteq G_1 \cap G_2$. So $f(\mathcal{F})$ is indeed a filterbase on (Y, \mathcal{T}_1) .

Now we know that f is continuous and $\mathcal{F} \rightarrow x$. Let U be any neighbourhood of $f(x)$ in (Y, \mathcal{T}_1) . As f is continuous, $f^{-1}(U)$ is a neighbourhood of x in (X, \mathcal{T}) . Since $\mathcal{F} \rightarrow x$, by [Definition 6.2.7](#) there exists $F \in \mathcal{F}$, such that $F \subseteq f^{-1}(U)$. So $f(F) \in f(\mathcal{F})$ and $f(F) \subseteq U$. Thus $f(\mathcal{F}) \rightarrow f(x)$, as required. \square

We now state and prove the converse of [Proposition A6.2.22](#).

A6.2.23 Proposition. Let (X, \mathcal{T}) and (Y, \mathcal{T}_1) be topological spaces and f a mapping of (X, \mathcal{T}) into (Y, \mathcal{T}_1) . If for each $x \in X$ and each filterbase $\mathcal{F} \rightarrow x$, the filterbase $f(\mathcal{F}) \rightarrow f(x)$, then f is a continuous mapping

Proof. Let U be any open set in (Y, \mathcal{T}_1) . We are required to show that the set $f^{-1}(U)$ is an open set in (X, \mathcal{T}) .

Let x be any point in the set $f^{-1}(U)$ and \mathcal{N}_x the neighbourhood filter at x in (X, \mathcal{T}) . By [Example A6.2.9](#), $\mathcal{N}_x \rightarrow x$. By assumption, $f(\mathcal{N}_x) \rightarrow f(x)$. As U is open, it is a neighbourhood of $f(x)$. So there exists a $G \in f(\mathcal{N}_x)$ such that $G \subseteq U$. However, $G = f(N)$, where $N \in \mathcal{N}_x$ and thus $f(N) \subseteq U$. Hence the neighbourhood N of x satisfies $N \subseteq f^{-1}(U)$.

So we have that the set $f^{-1}(U)$ contains a neighbourhood of x , for each $x \in f^{-1}(U)$. Thus $f^{-1}(U)$ is an open set, which completes the proof that f is continuous. \square

Exercises A6.2

1. Let \mathcal{F} be a filterbasis on a set X and \mathcal{G} be a filterbasis on a set Y . Prove that $\mathcal{F} \times \mathcal{G} = \{F \times G : F \in \mathcal{F}, G \in \mathcal{G}\}$ is a filterbasis on the product set $X \times Y$.
2. Prove the statement in [Remark A6.2.10](#).
3. Verify the claim in [Remarks A6.2.12\(ii\)](#) that 0 is a cluster point but not a limit point of \mathcal{G} .
4. Prove [Proposition A6.2.14](#).
5. Let (X, \mathcal{T}) be a topological space and \mathcal{U} a filterbase on (X, \mathcal{T}) . Then \mathcal{U} is said to be an **ultrafilterbase** (or an **ultrafilterbasis** or an **ultrafilter base** or **ultrafilter basis**) if the filter that it generates is an ultrafilter. Prove that \mathcal{U} is an ultrafilterbase if and only if for each set $S \subseteq X$ there exists an $F \in \mathcal{U}$ such that $S \supseteq F$ or $X \setminus S \supseteq F$.
6. (i) Verify [Remarks A6.2.16\(ii\)](#).
 (ii) In the example in [Remarks A6.2.16\(ii\)](#), find a refinement of the filterbase \mathcal{G} which has 0 as a limit point.
7. Verify [Corollary A6.2.20](#).
8. Prove that a metrizable topological space (X, \mathcal{T}) is compact if and only if every sequence of points in X has a subsequence converging to a point of X .
9. Let (X, \mathcal{T}) be a topological space. Prove that (X, \mathcal{T}) is Hausdorff if and only if every filterbasis, \mathcal{G} , on (X, \mathcal{T}) converges to at most one point.
 [Hint: See [Exercises A6.1 #9\(iii\)](#).]
10. Let \mathcal{G} be a filterbasis on the Euclidean space \mathbb{R} . Verify that $\mathcal{G} \rightarrow 0$ if and only if for every $\varepsilon > 0$ there exists a set $G \in \mathcal{G}$ such that $x \in G$ implies $|x| < \varepsilon$.
- 11.* Let (X_i, \mathcal{T}_i) , for $i \in I$, be a set of topological spaces and \mathcal{G} a filterbasis on the product space $\prod_{i \in I} (X_i, \mathcal{T}_i)$. Prove that the point $x \in \prod_{i \in I} (X_i, \mathcal{T}_i)$ is a limit point of \mathcal{G} if and only if $\phi_i(\mathcal{G}) \rightarrow \phi_i(x)$, for each $i \in I$, where ϕ_i is the projection mapping of $\prod_{i \in I} (X_i, \mathcal{T}_i)$ onto (X_i, \mathcal{T}_i) .

A6.3 Nets³⁸

In 1922 E.H. Moore and H.L. Smith in their paper, Moore and Smith [289], introduced the notion of a net as a generalization of a sequence. As we shall see, this notion is equivalent to the more elegant approach of filters introduced in 1937 by Henri Cartan (Cartan [69], Cartan [70]).

A partial order, \leq , on a set was defined in Definitions 10.2.1. A set with a partial order is called a partially ordered set. §10.2 gives a number of examples of partially ordered sets.

A6.3.1 Definition. A partially ordered set (D, \leq) is said to be a **directed set** if for any $a \in D$ and $b \in D$, there exists a $c \in D$ such that $a \leq c$ and $b \leq c$.

A6.3.2 Examples. It is easily seen that \mathbb{N} , \mathbb{Z} , \mathbb{Q} , and \mathbb{R} with the usual partial order are directed sets. □

A6.3.3 Example. Let (X, \mathcal{T}) be a topological space and a a point in X . Let D be the set of all neighbourhoods of the point a . Put a partial order \leq on D by $D_1 \leq D_2$ if $D_2 \subseteq D_1$, where the sets $D_1, D_2 \in D$. As the intersection of two neighbourhoods of a is a neighbourhood of a , it follows that $D_1 \cap D_2 \in D$, and $D_1 \cap D_2 \geq D_1$ and $D_1 \cap D_2 \geq D_2$. Thus (D, \leq) is a directed set. □

A6.3.4 Definition. Let (X, \mathcal{T}) be a topological space and (D, \leq) a directed set. Then a function $\phi : D \rightarrow X$ is said to be a **net** in the space (X, \mathcal{T}) .

It is often convenient to write the net ϕ above as $\{x_\alpha\}$ where $\phi(\alpha) = x_\alpha \in X$, $\alpha \in D$.

³⁸There are two 14 minute YouTube videos which provide an excellent introduction to this section. They are:- Topology Without Tears – Sequences and Nets –
Video 3a – <http://youtu.be/wXkNgyVg0JE> &
Video 3b – <http://youtu.be/xNqLF8GsRFE>

A6.3.5 Definition. Let (X, \mathcal{T}) be a topological space, (D, \leq) a directed set and $\phi : D \rightarrow X$ a net in (X, \mathcal{T}) . Then ϕ is said to **converge** to a point $a \in X$, denoted by $\phi \rightarrow a$ or $\{x_\alpha\} \rightarrow a$ or $a \in \lim\{x_\alpha\}$, and a is said to be a **limit** of the net ϕ , if for each neighbourhood U in (X, \mathcal{T}) of a , there exists a $\beta \in D$, such that $\phi(\alpha) \in U$, for every $\alpha \in D$ with $\beta \leq \alpha$.

If in [Definition A6.3.5](#) the limit of the net $\{x_\alpha\}$ is unique, then we write $\lim\{x_\alpha\} = a$.

A6.3.6 Proposition. Let (X, \mathcal{T}) be a topological space. Then it is Hausdorff if and only if no net in (X, \mathcal{T}) converges to more than one point.

Proof. Exercise. □

A6.3.7 Definition. Let (X, \mathcal{T}) be a topological space and $\{x_\alpha\}$ a net in (X, \mathcal{T}) , where α is in a directed set (D, \leq) . If Y is a subset of X , then $\{x_\alpha\}$ is said to be **eventually** in Y if there exists a $\beta \in D$ such that $x_\alpha \in Y$ for all $\beta \leq \alpha$.

Using [Definition A6.3.7](#) we can rephrase [Definition A6.3.5](#) as follows:

A6.3.8 Definition. Let (X, \mathcal{T}) be a topological space, (D, \leq) a directed set, $\{x_\alpha\}$ a net in (X, \mathcal{T}) , $\alpha \in D$, and $a \in X$. Then $\{x_\alpha\} \rightarrow a$ if for each neighbourhood U of a , x_α is eventually in U .

A6.3.9 Definition. Let (X, \mathcal{T}) be a topological space and $\{x_\alpha\}$ a net in (X, \mathcal{T}) , where α is in a directed set (D, \leq) . If Y is a subset of X , then $\{x_\alpha\}$ is said to be **frequently** or **cofinally** in Y if for each $\gamma \in D$, there exists a $\beta \in D$ such that $\gamma \leq \beta$ and $x_\beta \in Y$.

At this point we discuss the equivalence of filterbases and nets.

A6.3.10 Proposition. Let (X, \mathcal{T}) be a topological space, S a subset of X and a a point in X . Then a is a limit point of S if and only if there is a net in S converging to a .

Proof. Firstly let a be a limit point of S . Define a directed set D by

$$D = \{U : U \text{ is a neighbourhood of } a\} \text{ where, for } U_1, U_2 \in D, U_1 \leq U_2 \text{ if } U_1 \supseteq U_2.$$

As a is a limit point of S , $U \cap S \neq \emptyset$, for all $U \in D$. For each $U \in D$, let a_U be an arbitrary point of $U \cap S$. Then $\{a_U\}$ is a net. If V is any neighbourhood of a , then $V \in D$. For every $U \geq V$, $a_U \in U \subseteq V$. So we have that $\{a_U\} \rightarrow a$.

Conversely assume that $a \in X$ and $\{x_\alpha\} \rightarrow a$, where $x_\alpha \in S$, for α in a directed set D . Let U be any neighbourhood of a . Then there exists a $\beta \in D$, such that $\beta \leq \gamma \implies x_\gamma \in U$. So $U \cap S \neq \emptyset$. Thus a is a limit point of S , as required. \square

A6.3.11 Corollary. Let (X, \mathcal{T}) be a topological space and S a subset of X . Then S is a closed set in (X, \mathcal{T}) if and only if no net in S converges to a point of $X \setminus S$.

Proof. Exercise. \square

A6.3.12 Remark. Corollary A6.3.11 shows that nets (more precisely, convergent nets) can be used to describe the closed sets of (X, \mathcal{T}) , and therefore they also determine which subsets of (X, \mathcal{T}) are open sets. In short, nets (more precisely, convergent nets) determine the topology \mathcal{T} on X . This result can be compared with Corollary 6.2.12 where it was shown that filterbases (more precisely, convergent filterbases) determine the topology \mathcal{T} on X . \square

A6.3.13 Proposition. Let X be a set and $\{x_\alpha\}$ a net in X , where $\alpha \in D$, for a directed set D . For each $\beta \in D$, let $F_\beta = \{x_\alpha : \beta \leq \alpha\}$. Then $\mathcal{G} = \{F_\beta : \beta \in D\}$ is a filterbasis on X .

Proof. Exercise. □

A6.3.14 Definitions. Let (X, \mathcal{T}) be a topological space.

- (i) Let D be a directed set and $\{x_\alpha\}$, $\alpha \in D$, a net in (X, \mathcal{T}) . For each $\beta \in D$, let $F_\beta = \{x_\alpha : \beta \leq \alpha\}$. Put $\mathcal{G} = \{F_\beta : \beta \in D\}$. Then \mathcal{G} is said to be the **filterbase associated with the net** $\{x_\alpha\}$, $\alpha \in D$. If \mathcal{F} is the filter generated by the filterbase \mathcal{G} , then \mathcal{F} is said to be the **filter associated with the net** $\{x_\alpha\}$, $\alpha \in D$.
- (ii) Let \mathcal{G} be a filterbase on (X, \mathcal{T}) which generates the filter \mathcal{F} . Define the set $D = \{(x, F) : x \in F \in \mathcal{F}\}$. Define a partial ordering on D as follows: $(x_1, F_1) \leq (x_2, F_2)$ if $F_2 \subseteq F_1$. Then D is a directed set. Define $\phi : D \rightarrow X$ by $\phi((x, F)) = x$. Then ϕ is said to be the **net associated with the filter** \mathcal{F} and the **net associated with the filterbase** \mathcal{G} .

A6.3.15 Proposition. Let (X, \mathcal{T}) be a topological space and $a \in X$.

- (i) Let $\{x_\alpha\}$, $\alpha \in D$, D a directed set, be a net on (X, \mathcal{T}) . Let \mathcal{F} be the filter (respectively, filterbase) associated with the net $\{x_\alpha\}$, $\alpha \in D$. Then $\mathcal{F} \rightarrow a$ if and only if $\{x_\alpha\} \rightarrow a$.
- (ii) Let \mathcal{F} be a filter (respectively, filterbase) on (X, \mathcal{T}) . Then the net $\{x_\alpha\}$, $\alpha \in D$, associated with the filter (respectively, filterbase) \mathcal{F} . Then $\mathcal{F} \rightarrow a$ if and only if $\{x_\alpha\} \rightarrow a$.

Proof. Exercise. □

A6.3.16 Definition. Let (X, \mathcal{T}) be a topological space, D a directed set, and $\{x_\alpha\}, \alpha \in D$ a net in (X, \mathcal{T}) . Then $\{x_\alpha\}, \alpha \in D$ is said to be an **ultranet** (or a **universal net**) if for every subset S of X this net is eventually in either S or $X \setminus S$; that is, there exists a $\beta \in D$ such that either $x_\alpha \in S$ for all $\beta \leq \alpha$ or $x_\alpha \in X \setminus S$ for all $\beta \leq \alpha$

A6.3.17 Proposition. Let (X, \mathcal{T}) be a topological space, D a directed set, $\{x_\alpha\}, \alpha \in D$ a net on (X, \mathcal{T}) , and \mathcal{F} a filter on (X, \mathcal{T}) .

- (i) If $\{x_\alpha\}, \alpha \in D$, is an ultranet and \mathcal{F} is the filter associated with this net, then \mathcal{F} is an ultrafilter.
- (ii) If \mathcal{F} is an ultrafilter and $\{x_\alpha\}, \alpha \in D$, is the net associated with this filter, then $\{x_\alpha\}, \alpha \in D$, is an ultranet.

Proof. Exercise. □

A6.3.18 Proposition. Let X and Y be sets, D a directed set and $\{x_\alpha\}, \alpha \in D$, a net in X . If f is any function of X into Y , then $\{f(x_\alpha)\}, \alpha \in D$, is a net in Y .

Proof. Exercise. □

A6.3.19 Proposition. Let (X, \mathcal{T}_1) and (Y, \mathcal{T}_2) be topological spaces and f a function of X into Y . The map $f : (X, \mathcal{T}_1) \rightarrow (Y, \mathcal{T}_2)$ is continuous if and only if for each point a in X and each net $\{x_\alpha\}$ converging to a in (X, \mathcal{T}_1) , the net $\{f(x_\alpha)\}$ converges to $f(a)$ in (Y, \mathcal{T}_2) .

Proof. Exercise. □

Now we define the notion of a subnet, which is a generalization of that of a subsequence. However, it is slightly more technical than one might at first expect. This extra technicality is needed in order that certain properties of subnets that we want will be true.

A6.3.20 Definitions. Let X be a set, D_1 and D_2 directed sets, and $\phi_1 : D_1 \rightarrow X$ and $\phi_2 : D_2 \rightarrow X$ nets in X . A function $\theta : D_2 \rightarrow D_1$ is said to be **non-decreasing** if $\beta_1 \leq \beta_2 \implies \theta(\beta_1) \leq \theta(\beta_2)$, for all $\beta_1, \beta_2 \in D_2$. The function θ is said to be **cofinal** if for each $\alpha \in D_1$, there exists a $\beta \in D_2$ such that $\theta(\beta) \geq \alpha$. The net ϕ_2 is said to be a **subnet** of the net ϕ_1 if there exists a non-decreasing cofinal function $\theta : D_2 \rightarrow D_1$ such that $\phi_2 = \phi_1 \circ \theta$.

A6.3.21 Remark. In the literature there are two inequivalent definitions of subnet. As well as that used in [Definitions A6.3.20](#), another definition does not include that θ is non-decreasing but rather only that it is cofinal. \square

A6.3.22 Example. Let $D_1 = D_2 = \mathbb{N}$ with the usual ordering, let $\theta : \mathbb{N} \rightarrow \mathbb{N}$ be given by $\theta(n) = 3n$, for $n \in \mathbb{N}$, and (X, \mathcal{T}) any topological space. Clearly θ is a non-decreasing cofinal map. So if $x_1, x_2, \dots, x_n, \dots$ is any sequence in (X, \mathcal{T}) then it is also a net with directed set \mathbb{N} and the subsequence $x_3, x_6, \dots, x_{3n}, \dots$ is also a subnet. \square

A6.3.23 Example. Let $D_1 = D_2 = \mathbb{N}$ with the usual ordering, let $\theta : \mathbb{N} \rightarrow \mathbb{N}$ be given by $\theta(n) = 1 + \lfloor \frac{n}{2} \rfloor$, $n \in \mathbb{N}$, where $\lfloor x \rfloor$ denotes the integer part of x , for example $\lfloor \frac{5}{3} \rfloor = 1$, $\lfloor 4.9 \rfloor = 4$, $\lfloor 5 \rfloor = 5$. The map θ is non-decreasing and cofinal. So the sequence and net $x_1, x_2, \dots, x_n, \dots$ in (X, \mathcal{T}) has a subnet $x_1, x_2, x_2, x_3, x_3, x_4, x_4, x_5, \dots, x_{1+\lfloor \frac{n}{2} \rfloor}, \dots$ which is not a subsequence. So while every subsequence of a sequence is a subnet, not every subnet of a sequence is a subsequence. \square

A6.3.24 Example. Let \mathcal{T} be the discrete topology on the set X of all positive integers. Consider the directed sets $D_1 = \mathbb{N}$ and $D_2 = (1, \infty)$, with the usual orderings. Let $\phi_1 : \mathbb{N} \rightarrow X$ be the identity map and $\theta : (1, \infty) \rightarrow \mathbb{N}$ be given by $\theta(x) = [x]$, the integer part of x , $x \in (1, \infty)$. Let $\phi_2 : (1, \infty) \rightarrow X$ be defined by $\phi_2 = \phi_1 \circ \theta$. Clearly ϕ_1 and ϕ_2 are nets in X and ϕ_2 is a subnet of ϕ_1 by its very definition.

It is interesting to note that the directed set $D_1 = \mathbb{N}$ is a countable set, while the directed set $D_2 = (1, \infty)$ is an uncountable set. In other words, if we put $x_n = \phi_1(n)$, $n \in \mathbb{N}$ and $x_r = \phi_2(r)$, for $r \in (1, \infty)$, then the uncountable net $\{x_r\}$, $r \in (1, \infty)$, is a subnet of the countable sequence (and net) $\{x_n\}$, $n \in \mathbb{N}$. \square

A6.3.25 Definition. Let (X, \mathcal{T}) be a topological space and D a directed set. The point a is said to be a **cluster point of the net** $\{x_\alpha\}$, $\alpha \in D$, if for each neighbourhood U of a and each $\beta \in D$, there exists an $\alpha \in D$ such that $\alpha \geq \beta$ and $x_\alpha \in U$.

A6.3.26 Proposition. Let (X, \mathcal{T}) be a topological space, D a directed set, $a \in X$, and $\{x_\alpha\}$, $\alpha \in D$ a net in (X, \mathcal{T}) . If $\{x_\alpha\} \rightarrow a$ then a is a cluster point of the net $\{x_\alpha\}$.

Proof. Exercise. \square

The next proposition tells us that a cluster point of a subnet of a net is also a cluster point of the net.

A6.3.27 Proposition. Let (X, \mathcal{T}) be a topological space, D_1 and D_2 directed sets, $a \in X$, $\phi : D_1 \rightarrow X$ a net in (X, \mathcal{T}) with subnet $\phi \circ \theta : D_2 \rightarrow X$, where $\theta : D_2 \rightarrow D_1$ is a non-decreasing cofinal map. If a is a cluster point of the subnet $\phi \circ \theta : D_2 \rightarrow X$ then a is also a cluster point of the net $\phi : D_1 \rightarrow X$.

Proof. Exercise. □

A6.3.28 Proposition. Let (X, \mathcal{T}) be a topological space, D_1 a directed set, $a \in X$, and $\{x_\alpha\}, \alpha \in D_1$ a net in (X, \mathcal{T}) . Then a is a cluster point of the net $\{x_\alpha\}, \alpha \in D_1$, if and only if the net has a subnet which converges to a .

Proof. Firstly assume that the net $\{x_\alpha\}, \alpha \in D_1$, has a as a cluster point. Put $D_2 = \{(\alpha, U) : \alpha \in D_1, U \text{ a neighbourhood of } a \text{ such that } x_\alpha \in U\}$. Define a partial ordering on D_2 by $(\alpha_1, U_1) \leq (\alpha_2, U_2)$ when $\alpha_1 \leq \alpha_2$ and $U_1 \supseteq U_2$. We claim that D_2 is a directed set. To see this let $(\alpha_1, U_1) \in D_2$ and $(\alpha_2, U_2) \in D_2$. As $\alpha_1, \alpha_2 \in D_1$ and D_1 is a directed set, there exists an $\alpha_3 \in D_1$ with $\alpha_1 \leq \alpha_3$ and $\alpha_2 \leq \alpha_3$. Put $U_3 = U_1 \cap U_2$, so that we have $U_1 \supseteq U_3$ and $U_2 \supseteq U_3$. As a is a cluster point and $a \in U_3$, there exist an α_4 with $\alpha_3 \leq \alpha_4$ such that $x_{\alpha_4} \in U_3$. So $(\alpha_4, U_3) \in D_2$. As $\alpha_1 \leq \alpha_4, \alpha_2 \leq \alpha_4, U_1 \supseteq U_3$ and $U_2 \supseteq U_3$, we see that $(\alpha_1, U_1) \leq (\alpha_4, U_3)$ and $(\alpha_2, U_2) \leq (\alpha_4, U_3)$. So D_2 is indeed a directed set.

Define a map $\theta : D_2 \rightarrow D_1$ by $\theta(\alpha, U) = \alpha$, where $\alpha \in D_1$ and U is a neighbourhood of a . Clearly θ is non-decreasing. Now consider any $\alpha \in D_1$. As a is a cluster point, for any neighbourhood U of a , there exists a $\gamma \in D_1$ with $\alpha \leq \gamma$ such that $x_\gamma \in U$. So $(\gamma, U) \in D_2$ and we have $\theta((\gamma, U)) = \gamma$ and $\alpha \leq \gamma$. So θ is also cofinal. For notational convenience, write $\phi : D_1 \rightarrow X$ where $\phi(\alpha) = x_\alpha, \alpha \in D_1$. Then $\phi \circ \theta : D_2 \rightarrow X$ is a subnet of the net $\{x_\alpha\}, \alpha \in D_1$.

As a is a cluster point of the net $\{x_\alpha\}, \alpha \in D_1$, for each neighbourhood U_0 of a and each $\alpha_0 \in D_1$, there exists a $\beta \in D_1, \alpha_0 \leq \beta$ such that $x_\beta \in U_0$. Then by the definition of D_2 , for any $(\alpha, U) \in D_2$ with $(\beta, U_0) \leq (\alpha, U)$ we have $x_\alpha \in U$ and $U \subseteq U_0$. So $x_\alpha \in U_0$. In other words, $\phi \circ \theta(\alpha, U) \subseteq U_0$, for all $(\beta, U_0) \leq (\alpha, U)$; that is the subnet $\phi \circ \theta$ converges to a .

The converse follows immediately from [Propositions A6.3.26](#) and [A6.3.27](#). □

A6.3.29 Proposition. Let (X, \mathcal{T}) be a topological space. Then (X, \mathcal{T}) is compact if and only if every ultranet in (X, \mathcal{T}) converges.

Proof. This follows immediately from [Propositions A6.1.24](#), [A6.3.15](#) and [A6.3.17](#). □

A6.3.30 Proposition. Every net has a subnet which is an ultranet.

Proof. Exercise. □

A6.3.31 Proposition. Let (X, \mathcal{T}) be a topological space. The following are equivalent;

- (i) (X, \mathcal{T}) is compact;
- (ii) Every net in (X, \mathcal{T}) has a subnet which converges;
- (iii) Every net in (X, \mathcal{T}) has a cluster point.

Proof. Exercise. □

Exercises A6.3

1. Verify that the partially ordered sets in [Examples 10.2.3](#) and [Examples 10.2.4](#) are directed sets.
2. Verify that if (X, \mathcal{T}) is a Hausdorff space, then a net in (X, \mathcal{T}) converges to at most one point.
3. Prove the converse of the result in [Exercise 2 above](#), namely that if (X, \mathcal{T}) is a topological space such that no net converges to two distinct points of X , then (X, \mathcal{T}) is Hausdorff.

4. (i) Let S be any infinite set and, using the [Axiom of Choice](#), select subsets $S_1, S_2, \dots, S_n, \dots, n \in \mathbb{N}$, such that $S = \bigcup_{n=1}^{\infty} S_n$.
- (ii) Using the [Well-Ordering Theorem](#) on each $S_n, n \in \mathbb{N}$, define a partial ordering \leq on all of S such that $x \leq y$ if $x \in S_i$ and $y \in S_j$, where $i \leq j$.
- (iii) Verify that with this ordering, S is a directed set.
- (iv) Deduce that for every infinite cardinal number, \aleph , there is a directed set of cardinality \aleph .
5. Prove [Corollary A6.3.11](#).
6. Prove [Proposition A6.3.13](#).
7. Prove [Proposition A6.3.15](#).
8. Prove [Proposition A6.3.17](#).
9. Prove [Proposition A6.3.18](#).
10. Prove [Proposition A6.3.19](#).
11. Let $D_1 = D_2 = \mathbb{R}$ with the usual ordering. Which of the following maps $\theta : D_2 \rightarrow D_1$ are non-decreasing and which are cofinal?
- (i) $\theta(x) = x^2$, for all $x \in \mathbb{R}$.
- (ii) $\theta(x) = |x|$, for all $x \in \mathbb{R}$.
- (iii) $\theta(x) = \sin x$, for all $x \in \mathbb{R}$.
- (iv) $\theta(x) = 2^x$, for all $x \in \mathbb{R}$.
- (v) $\theta(x) = 2x^3 - 3x$, for all $x \in \mathbb{R}$.
12. Prove the following:
- (i) Every net is a subnet of itself.
- (ii) If $\{x_\gamma\}, \gamma \in D_3$, is a subnet of the net $\{x_\beta\}, \beta \in D_2$, and $\{x_\beta\}, \beta \in D_2$, is a subnet of the net $\{x_\alpha\}, \alpha \in D_1$, then $\{x_\gamma\}, \gamma \in D_3$, is also a subnet of $\{x_\alpha\}, \alpha \in D_1$.

13. Let (X, \mathcal{T}) be any topological space, where X is an infinite set. Let $D_1 = D_2 = \mathbb{Q}$ and $x_1, x_2, x_3, \dots, x_n, \dots$ a sequence in (X, \mathcal{T}) . Find two subnets of this sequence neither of which is a subsequence of the sequence $x_1, x_2, x_3, \dots, x_n, \dots$.
14. Using [Exercise 4 above](#) and [Example A6.3.24](#), prove that for each cardinal number \aleph , every infinite sequence $x_1, x_2, \dots, x_n, \dots$ in a topological space (X, \mathcal{T}) has a subnet $\{x_\alpha\}$, $\alpha \in D$, where D has cardinality \aleph .
15. Prove [Proposition A6.3.26](#).
16. Prove [Proposition A6.3.27](#).
17. Prove [Proposition A6.3.30](#).
18. Using [Propositions A6.3.29](#), [A6.3.30](#), and [A6.3.28](#) prove [Proposition A6.3.31](#).

A6.4 Wallman Compactifications: An Application of Ultrafilters

Repeatedly throughout the study of topology we are interested in whether a given topological space can be embedded as a subspace of a topological space with nicer properties. In metric space theory we know that not every metric space is complete. But can every metric space be embedded as a metric subspace of a complete metric space? The answer is “yes”, and was proved in [Proposition 6.3.23](#).

This was achieved by first recognizing that a metric space is complete if and only if every Cauchy sequence converges. So a metric space which fails to be complete must have Cauchy sequences which are not convergent. For example in \mathbb{Q} with the euclidean metric, we easily find Cauchy sequences of rational numbers which do not converge (to any rational number).

So we need to enlarge the metric space with extra points so that the Cauchy sequences which did not converge previously now converge to one of the extra points. In the case of \mathbb{Q} , we add what is effectively the irrational numbers, and the completion is \mathbb{R} .

So the “trick” or rather the “technique”, is to identify why the given topological space fails to have the desired property and then add extra points in such a way that the topological space with the extra points does have the desired property.

In 1937 M.H. Stone and E. Čech introduced what is now known as the Stone-Čech compactification which is defined in [Definition 10.4.1](#). They showed that a topological space can be embedded as a subspace of a compact Hausdorff space if and only if it is completely regular and Hausdorff, that is it is a Tychonoff space. This is discussed in [§10.4](#).

In 1938 H. Wallman (Wallmani [418]) proved that a topological space can be embedded as a subspace of a compact T_1 -space if and only if it is a T_1 -space.

We shall now describe the Wallman compactification. If we are given a T_1 -space which is not compact, how can we enlarge the space to obtain a compact T_1 -space? To answer this we find a convenient property for testing compactness. We know several such properties. We look for one which is most convenient. As indicated in the title of this section, we shall use ultrafilters.

Note [Proposition 10.3.2](#) states that a topological space (X, \mathcal{T}) is compact if and only if for every family \mathcal{F} of closed subsets of X with the finite intersection (F.I.P.) property (see [Definition 10.3.1](#)) $\bigcap_{F \in \mathcal{F}} F \neq \emptyset$.

So we shall focus our intention on families of closed sets with the finite intersection property. Now we know that filters and ultrafilters, in particular, have the F.I.P. But, in almost all topological spaces, families of closed sets cannot form a filter, since any set which contains a set in the filter is also in the filter.

Therefore we shall modify the notion of an ultrafilter so that the modification still has all the desired properties of an ultrafilter but can consist of only closed sets.

A6.4.1 Definitions. Let (X, \mathcal{T}) be a topological space and \mathcal{C} the set of all closed subsets of X . A non-empty subset \mathcal{F} of \mathcal{C} is said to be a **filter in \mathcal{C}** if

- (i) $F_1, F_2 \in \mathcal{F}$ implies $F_1 \cap F_2 \in \mathcal{F}$;
- (ii) $F \in \mathcal{F}$ and $F \subseteq G \in \mathcal{C} \implies G \in \mathcal{F}$; and
- (iii) $\emptyset \notin \mathcal{F}$.

A filter \mathcal{U} in \mathcal{C} is said to be an **ultrafilter in \mathcal{C}** if no filter in \mathcal{C} is strictly finer than \mathcal{U} .

An ultrafilter \mathcal{U} in \mathcal{C} is said to be a **free ultrafilter in \mathcal{C}** if $\bigcap_{U \in \mathcal{U}} U = \emptyset$.

We record some useful facts about ultrafilters in the set of all closed sets, \mathcal{C} , on a topological space (X, \mathcal{T}) .

The proof of [Proposition A6.4.2](#) is analagous to that of [The Ultrafilter Lemma A6.1.10](#) and [Corollary A6.1.12](#).

A6.4.2 Proposition. Let \mathcal{F} be any filter in \mathcal{C} , the set of all closed sets, on a topological space (X, \mathcal{T}) . Then there exists an ultrafilter \mathcal{U} in \mathcal{C} which is finer than \mathcal{F} .

Indeed if \mathcal{S} is a non-empty set of closed subsets of X and \mathcal{S} has the F.I.P., then there is an ultrafilter \mathcal{U} in \mathcal{C} such that $\mathcal{S} \subseteq \mathcal{U}$.

A6.4.3 Proposition. Let \mathcal{U} be an ultrafilter in \mathcal{C} , the set of closed sets in a topological space (X, \mathcal{T}) .

- (i) $F \in \mathcal{U}$ and $F \subseteq G \in \mathcal{C} \implies G \in \mathcal{U}$;
- (ii) Let $F_1, F_2 \in \mathcal{C}$. Then $F_1, F_2 \in \mathcal{U} \iff F_1 \cap F_2 \in \mathcal{U}$;
- (iii) $\emptyset \notin \mathcal{U}$;
- (iv) $F_1, F_2 \in \mathcal{U} \implies F_1 \cap F_2 \neq \emptyset$;
- (v) $\{F : F \in \mathcal{U}\}$ has the F.I.P.;
- (vi) Let $A, B \in \mathcal{C}$. Then $A \cup B \in \mathcal{U} \iff A \in \mathcal{U}$ or $B \in \mathcal{U}$;
- (vii) Let $A \in \mathcal{C}$. Then $A \in \mathcal{U} \iff A \cap F \neq \emptyset$, for all $F \in \mathcal{U}$;
- (viii) Let \mathcal{U} and \mathcal{U}' be ultrafilters in \mathcal{C} . Then
 $\mathcal{U} \neq \mathcal{U}' \iff$ there exist sets $A \in \mathcal{U}$ and $B \in \mathcal{U}'$ such that $A \cap B = \emptyset$;
- (ix) Let $A \in \mathcal{C}$. Then $A \notin \mathcal{U} \iff A \subseteq X \setminus F$, for some $F \in \mathcal{U}$;
- (x) Let $O \in \mathcal{T}$. Then $X \setminus O \notin \mathcal{U} \iff F \subseteq O$, for some $F \in \mathcal{U}$.

Proof. (i), (ii), and (iii) follow from [Definitions A6.4.1 \(i\), \(ii\) and \(iii\)](#), respectively, while (iv) is a consequence of (1) and (iii) and (v) is a consequence of (iv).

In (vi) \implies is proved analogously to [Proposition A6.1.13](#). The converse follows from (i) above.

In (vii) \implies follows from (iv). The proof of the converse in (vii) is analogous to the second paragraph of the proof of [Proposition A6.1.13](#).

(viii) follows from (vii) and (iv).

(ix) follows from (vii).

(x) follows from (ix). □

If \mathcal{U} is any ultrafilter in \mathcal{C} , then it has the finite intersection property. If \mathcal{U} is a free ultrafilter, then (X, \mathcal{T}) is not compact by [Proposition 10.3.2](#). Let \mathfrak{F} be the set of all free ultrafilters in \mathcal{C} . We shall expand the space (X, \mathcal{T}) by adding extra “points” using these free ultrafilters.

Let ωX be the set $X \cup \mathfrak{F}$.

A6.4.4 Remarks. So each point in ωX is either a point in X or a free ultrafilter in \mathcal{C} . At first sight this might appear strange, but a set is just a collection of objects. In this case there are two kinds of objects in ωX , namely points and free ultrafilters in \mathcal{C} .

Our task is to define a topology on ωX in such a way that it has (X, \mathcal{T}) as a subspace, and that with this topology ωX is a compact T_1 -space.

For each open subset O of (X, \mathcal{T}) , define the subset O^* of ωX by

$$O^* = O \cup \{\mathcal{U} \in \mathfrak{F} : X \setminus O \notin \mathcal{U}\}. \quad (1)$$

$$\text{Then } X^* = X \cup \{\mathcal{U} \in \mathfrak{F} : \emptyset \notin \mathcal{U}\} = X \cup \mathfrak{F} = \omega X \text{ and } O^* = \emptyset \iff O = \emptyset. \quad (2)$$

For each closed subset A of (X, \mathcal{T}) , define the subset A_* of ωX by

$$A_* = A \cup \{\mathcal{U} \in \mathfrak{F} : A \in \mathcal{U}\}. \quad (3)$$

$$\text{Then } X_* = X \cup \{\mathcal{U} \in \mathfrak{F} : X \in \mathcal{U}\} = X \cup \mathfrak{F} = \omega X \text{ and } A_* = \emptyset \iff A = \emptyset. \quad (4)$$

Noting that (X, \mathcal{T}) is a T_1 -space, for $x \in X$, $\{x\}$ is a closed set in (X, \mathcal{T}) and so

$$\{x\}_* = \{x\} \cup \{\mathcal{U} \in \mathfrak{F} : \{x\} \in \mathcal{U}\} = \{x\} \cup \emptyset = \{x\} \quad (5)$$

We shall show that $\mathcal{B} = \{O^* : O \in \mathcal{T}\}$ is a basis for a topology \mathcal{T}_ω on ωX and that this topological space $(\omega X, \mathcal{T}_\omega)$ is a compact T_1 -space which has (X, \mathcal{T}) as a subspace.

We claim that for any $O \in \mathcal{T}$

$$O^* = \omega X \setminus (X \setminus O)_*. \quad (6)$$

Proof of (6).

$$\begin{aligned} \omega X \setminus (X \setminus O)_* &= (X \cup \mathcal{F}) \setminus ((X \setminus O) \cup \{\mathcal{U} \in \mathfrak{F} : X \setminus O \in \mathcal{U}\}), \text{ by (3)} \\ &= (X \setminus (X \setminus O)) \cup (\mathfrak{F} \setminus \{\mathcal{U} \in \mathfrak{F} : X \setminus O \in \mathcal{U}\}) \\ &= O \cup \{\mathcal{U} \in \mathfrak{F} : X \setminus O \notin \mathcal{U}\} \\ &= O^*, \text{ by (1), which completes the proof. } \quad \square \end{aligned}$$

Similarly for any closed set A in (X, \mathcal{T}) , we can show that

$$A_* = \omega X \setminus (X \setminus A)^*. \quad (7)$$

We claim that for any $A_1, A_2 \in \mathcal{C}$,

$$(A_1 \cap A_2)_* = A_{1*} \cap A_{2*}. \quad (8)$$

Proof of (8).

$$\begin{aligned} A_{1*} \cap A_{2*} &= (A_1 \cup \{\mathcal{U} \in \mathfrak{F} : A_1 \in \mathcal{U}\}) \cap (A_2 \cup \{\mathcal{U} \in \mathfrak{F} : A_2 \in \mathcal{U}\}), \text{ by (3)} \\ &= (A_1 \cap A_2) \cup \{\mathcal{U} \in \mathcal{F} : A_1, A_2 \in \mathcal{U}\} \\ &= (A_1 \cap A_2) \cup \{\mathcal{U} \in \mathfrak{F} : A_1 \cap A_2 \in \mathcal{U}\}, \text{ by Proposition A6.4.3(ii)} \\ &= (A_1 \cap A_2)_*, \text{ by (3), which completes the proof } \quad \square \end{aligned}$$

Similarly we can show that

$$(A_1 \cup A_2)_* = A_{1*} \cup A_{2*}. \quad (9)$$

We claim that for $O_1, O_2 \in \mathcal{T}$

$$(O_1 \cup O_2)^* = O_1^* \cup O_2^*. \quad (10)$$

(10) follows from (6) and (3) and so its proof is left as an exercise.

We also leave the proof of (11) as an exercise.

$$(O_1 \cap O_2)^* = O_1^* \cap O_2^*. \quad (11)$$

As a consequence of (8) and the second part of (4) we obtain

$$\text{Let } A_1, A_2, \dots, A_n \in \mathcal{C}. \quad \text{Then } \bigcap_{i=1}^n A_i = \emptyset \iff \bigcap_{i=1}^n A_{i_*} = \emptyset. \quad (12)$$

It follows immediately from (12) that for $A_i \in \mathcal{C}$, $i \in I$, any index set,

$$\{A_i : i \in I\} \text{ has the F.I.P.} \iff \{A_{i_*} : i \in I\} \text{ has the F.I.P.} \quad (13)$$

Now by [Proposition 2.2.8](#), (11) and (2) imply that the set $\mathcal{B} = \{O^* : O \in \mathcal{T}\}$ is indeed a basis for a topology \mathcal{T}_ω on ωX . So every open set in $(\omega X, \mathcal{T}_\omega)$ is a union of members of \mathcal{B} . Every closed set in $(\omega X, \mathcal{T}_\omega)$ is therefore an intersection of closed sets A_* , where A is closed in (X, \mathcal{T}) .

A6.4.5 Definition. Let (X, \mathcal{T}) be a T_1 -space. Then the topological space $(\omega X, \mathcal{T}_\omega)$ is called the **Wallman compactification** of X .

A6.4.6 Theorem. Let (X, \mathcal{T}) be a T_1 -space. Then its Wallman compactification $(\omega X, \mathcal{T}_\omega)$ is a compact T_1 -space that contains (X, \mathcal{T}) as a dense subspace. Further, every continuous map of (X, \mathcal{T}) into a compact Hausdorff space (K, \mathcal{T}_1) extends to a continuous map of $(\omega X, \mathcal{T}_\omega)$ into (K, \mathcal{T}_1) .

Proof. The fact that (X, \mathcal{T}) is a subspace of $(\omega X, \mathcal{T}_\omega)$ follows immediately from the definitions of ωX , \mathcal{B} , \mathcal{T}_ω , and O^* , for $O \in \mathcal{T}$. That X is dense in $(\omega X, \mathcal{T}_\omega)$ follows immediately from the the definition of the basic open sets O^* , $O \in \mathcal{T}$, as each (non-empty) O^* intersects X non-trivially.

Next we shall prove that $(\omega X, \mathcal{T}_\omega)$ is a T_1 -space, that is each point is a closed set. We know that there are two kinds of points in ωX , namely $x \in X$ and \mathcal{U} , where $\mathcal{U} \in \mathfrak{F}$. By (4) above each $\{x\} = \{x\}_*$ and so is a closed set in $(\omega X, \mathcal{T}_\omega)$. Noting that if $\mathcal{U}, \mathcal{F} \in \mathfrak{F}$ are distinct ultrafilters, there exists $A \in \mathcal{U}$ such that $A \notin \mathcal{F}$, because otherwise \mathcal{F} would be a finer filter in \mathcal{C} than \mathcal{U} , which contradicts \mathcal{U} being an ultrafilter in \mathcal{C} . Therefore

$$\bigcap_{A \in \mathcal{U}} \{\mathcal{F} \in \mathfrak{F} : A \in \mathcal{F}\} = \{\mathcal{U}\}. \quad (14)$$

Using (14), the fact that \mathcal{U} is a free ultrafilter in \mathcal{C} , and (3) which says that $A_* = A \cup \{\mathcal{F} \in \mathfrak{F} : A \in \mathcal{F}\}$ we obtain that

$$\bigcap_{A \in \mathcal{U}} A_* = \left(\bigcap_{A \in \mathcal{U}} A \right) \cup \left(\bigcap_{A \in \mathcal{U}} \{\mathcal{F} \in \mathfrak{F} : A \in \mathcal{F}\} \right) = (\emptyset) \cup (\{\mathcal{U}\}) = \{\mathcal{U}\}.$$

Thus \mathcal{U} is the intersection of the closed sets A_* , $A \in \mathcal{U}$, and so is a closed set. So we have that every $\{x\}$ and every \mathcal{U} is a closed set in $(\omega X, \mathcal{T}_\omega)$. Thus $(\omega X, \mathcal{T}_\omega)$ is indeed a T_1 -space.

Finally, we need to show that $(\omega X, \mathcal{T}_\omega)$ is compact. Let I be an index set and $\{C_i : i \in I\}$ a set of closed subsets of ωX with the F.I.P. We are required to prove that $\bigcap_{i \in I} C_i \neq \emptyset$.

As noted earlier, each $C_i = \bigcap_{j \in J} (A_{ij})_*$, for some index set J , where each A_{ij} is a closed subset of X . Therefore $\{(A_{ij})_* : i \in I, j \in J\}$ has the F.I.P.. By (12)

this implies that $\{A_{ij} : i \in I, j \in J\}$ has the F.I.P.. So by [Proposition A6.4.2](#) there exists an ultrafilter \mathcal{U} in \mathcal{C} containing $\{A_{ij} : i \in I, j \in J\}$.

If $\bigcap_{U \in \mathcal{U}} U \neq \emptyset$, then there exists an $x \in X$ with $x \in \bigcap_{U \in \mathcal{U}} U$. This implies $x \in \bigcap_{i \in I} \bigcap_{j \in J} A_{ij}$ and so $x \in \bigcap_{i \in I} \bigcap_{j \in J} (A_{ij})_*$. Thus $\bigcap_{i \in I} C_i \neq \emptyset$, as required.

If $\bigcap_{U \in \mathcal{U}} U = \emptyset$, \mathcal{U} is a free ultrafilter in \mathcal{C} . Now each $A_{ij} \in \mathcal{U}$ and so, by (2), $\mathcal{U} \in (A_{ij})_*$. Therefore $\mathcal{U} \in \bigcap_{i \in I} \bigcap_{j \in J} (A_{ij})_* = \bigcap_{i \in I} C_i$. Thus $\bigcap_{i \in I} C_i \neq \emptyset$, as required.

So in both cases, $\bigcap_{i \in I} C_i \neq \emptyset$. Hence $(\omega X, \mathcal{T}_\omega)$ is compact.

Let $\phi : (X, \mathcal{T})$ be a continuous map of (X, \mathcal{T}) into (K, \mathcal{T}_1) . We shall apply [Proposition 10.3.53](#) to obtain the required result. So let C_1, C_2 be disjoint closed subsets of (K, \mathcal{T}_1) . As $\phi : (X, \mathcal{T}) \rightarrow (K, \mathcal{T}_1)$ is continuous, $\phi^{-1}(C_1)$ and $\phi^{-1}(C_2)$ are disjoint closed subsets of (X, \mathcal{T}) . So by (8) and (2), $[\phi^{-1}(C_1)]_*$ and $[\phi^{-1}(C_2)]_*$ are disjoint closed subsets of $(\omega X, \mathcal{T}_\omega)$. As $[\phi^{-1}(C_1)]_*$ is a closed set containing $\phi^{-1}(C_1)$ and $[\phi^{-1}(C_2)]_*$ is a closed set containing $\phi^{-1}(C_2)$, the closures in ωX of $\phi^{-1}(C_1)$ and $\phi^{-1}(C_2)$ are disjoint. By [Proposition 10.3.53](#), $\phi : (X, \mathcal{T}) \rightarrow (K, \mathcal{T}_1)$ has a continuous extension $(\omega X, \mathcal{T}_\omega) \rightarrow (K, \mathcal{T}_1)$, which completes the proof of the theorem. \square

A6.4.7 Proposition. Let (X, \mathcal{T}) be a T_1 -space. The following conditions are equivalent:

- (i) The Wallman compactification $(\omega X, \mathcal{T}_\omega)$ is a Hausdorff space;
- (ii) (X, \mathcal{T}) is a normal space.

Proof. (i) \implies (ii): If $(\omega X, \mathcal{T}_\omega)$ is a Hausdorff space, it is compact Hausdorff which, by [Remark 10.3.28](#), implies that it is a normal space. Now let C_1 and C_2 be disjoint closed subsets of (X, \mathcal{T}) . Then by [Remarks A6.4.4 \(8\)](#) and [\(2\)](#), $(C_1)_*$ and $(C_2)_*$ are disjoint closed sets in the normal space $(\omega X, \mathcal{T}_\omega)$. So there exist disjoint $O_1, O_2 \in \mathcal{T}_\omega$, such that $(C_1)_* \subseteq O_1$ and $(C_2)_* \subseteq O_2$. Then the disjoint sets $O_1 \cap X$ and $O_2 \cap X$ are open sets in (X, \mathcal{T}) which respectively contain C_1 and C_2 . So (X, \mathcal{T}) is a normal space.

(ii) \implies (i): Assume (X, \mathcal{T}) is normal. We need to show that if $z_1, z_2 \in \omega X = X \cup \mathcal{F}$, then there are disjoint open sets containing z_1 and z_2 respectively. So we need to consider the cases: (a) $z_1, z_2 \in \mathcal{F}$; (b) $z_1 \in X$ and $z_2 \in \mathcal{F}$; (c) $z_1, z_2 \in X$.

(a): Let $\mathcal{U}_1, \mathcal{U}_2 \in \mathcal{F}$ be distinct. By [Proposition A6.4.3 \(viii\)](#), there exist closed subsets A_1 and A_2 of (X, \mathcal{T}) such that $A_1 \in \mathcal{U}_1$ and $A_2 \in \mathcal{U}_2$ and $A_1 \cap A_2 = \emptyset$. As (X, \mathcal{T}) is normal, there exist disjoint open sets U_1, U_2 in (X, \mathcal{T}) such that $A_1 \subseteq U_1$ and $A_2 \subseteq U_2$. By (11), U_1^* and U_2^* are disjoint open sets in $(\omega X, \mathcal{T}_\omega)$. By [Proposition A6.4.3 \(x\)](#), this implies that $X \setminus U_1 \notin \mathcal{U}_1$ and $X \setminus U_2 \notin \mathcal{U}_2$. By (1) these imply $\mathcal{U}_1 \subseteq U_1^*$ and $\mathcal{U}_2 \subseteq U_2^*$, which complete the proof for case (a).

(b): Let $x_1 \in X$ and $\mathcal{U}_2 \in \mathcal{F}$. As \mathcal{U}_2 is a free ultrafilter in \mathcal{C} , there exists $A_2 \in \mathcal{U}_2$ with $x_1 \notin A_2$. Put $A_1 = \{x_1\}$. As in (a), there exist disjoint open sets U_1, U_2 in (X, \mathcal{T}) containing A_1 and A_2 respectively, such that U_1^* and U_2^* are disjoint open sets in $(\omega X, \mathcal{T}_\omega)$ with $x_1 \in U_1$ and $\mathcal{U}_2 \in U_2$. This completes the proof of case (b).

(c): Let $x_1, x_2 \in X$. Then there exist disjoint open sets U_1, U_2 in (X, \mathcal{T}) which contain x_1 and x_2 , respectively. Then U_1^* and U_2^* are disjoint open sets in $(\omega X, \mathcal{T}_\omega)$ which contain x_1 and x_2 , respectively. This completes the proof of case (c) and of the proposition. \square

A6.4.8 Corollary. The following conditions are equivalent:

- (i) (X, \mathcal{T}) is a normal Hausdorff space.
- (ii) The Wallman compactification ωX is the Stone-Čech compactification βX .

Proof. Exercise. □

A6.4.9 Corollary. Let X be any unbounded subset of a normed vector space and \mathcal{T} be the subspace topology on X . Then

$$\beta X = \omega X \text{ and } \text{card}(\beta X) = \text{card}(\omega X) \geq 2^c.$$

In particular, for non-negative integers a, b, c , and d with $a + b + c + d > 0$, $\text{card}(\omega(\mathbb{N}^a \times \mathbb{Q}^b \times \mathbb{P}^c \times \mathbb{R}^d)) = 2^c$.

Proof. Exercise. □

A6.4.10 Corollary. If (X, \mathcal{T}) is a discrete space of infinite cardinality m , then $\text{card}(\omega X) = 2^{2^m}$.

Proof. Exercise. □

A6.4.11 Proposition. If X is any infinite set of cardinality m , then it has 2^{2^m} distinct ultrafilters.

Proof. Put the discrete topology on the set X . Then $\omega X = X \cup \mathcal{F}$, where \mathcal{F} is the set of free ultrafilters. (On a discrete space every free ultrafilter is a free ultrafilter on the closed sets.) So, by [Corollary A6.4.10](#), \mathcal{F} must have cardinality m .

The proof that X cannot have more than 2^{2^m} ultrafilters is left as an exercise. □

Exercises A6.4

1. Let (X, \mathcal{T}) be a completely regular Hausdorff space.
 - (i) Verify that there exists a continuous mapping of the Wallman compactification ωX onto the Stone-Čech compactification βX .
[Hint. Use the last part of the statement of [Theorem A6.4.6](#).]
 - (ii) Deduce from (i) that $\text{card}(\omega X) \geq \text{card}(\beta X)$.
2. Using [Theorem A6.4.6](#), verify [Corollary A6.4.8](#).
3. Prove [Corollary A6.4.9](#).
[Hint. Use [Corollary A6.4.8](#) and [Proposition 10.4.17](#).]
4. Prove [Corollary A6.4.10](#).
[Hint. Use [Corollary A6.4.8](#)]
5. Verify that a set of infinite cardinality m cannot have more than 2^{2^m} ultrafilters.

Bibliography

- [1] N.H. Abel. Mémoire sur une classe particulière d'équations résolubles algébriquement. *J. reine und angewandte Mathematik*, 4:131–156, 1829.
- [2] Alexander Abian. *The theory of sets and transfinite arithmetic*. Saunders., Philadelphia, 1965.
- [3] Victor S. Adamchik and David J. Jeffrey. Polynomial transformations of Tschirnhaus, Bring and Jerrard. *ACM SIGSAM Bulletin*, 37:90–94, 2003
<https://tinyurl.com/ybazbzx3>.
- [4] Colin C. Adams. *The knot book: an elementary introduction to the mathematical theory of knots*. Freeman and Co., New York, 1994.
- [5] J. Frank Adams. *Lectures on Lie Groups*. University of Chicago PressPress, Chicago, 1969.
- [6] J. Frank Adams. *Algebraic topology: a student's guide*. Cambridge University Press, Cambridge, England, 1972.
- [7] G.N. Afanasiev. *Topological effects in quantum mechanics*. Kluwer Academic Publishers, Dordrecht, Boston, 1999.
- [8] M.A. Aguilar, S. Gitler, and C. Prieto. *Algebraic topology from a homotopical viewpoint*. Springer, New York, 2002.
- [9] Paul S. Alexandroff and Heinz Hopf. *Topologie*. Springer-Verlag, Berlin, 1935.
- [10] *Algebraic and Geometric Topology*. <http://www.maths.warwick.ac.uk/agt>, 2001–. a refereed electronic journal.
- [11] Frederic D. Ancel, Tadeusz Dobrowski, and Janusz Grabowski. Closed subgroups in Banach spaces. *Studia Math.*, 109(3):277–290, 1994.

- [12] R.D. Anderson and R.H. Bing. A completely elementary proof that Hilbert space is homeomorphic to the countable product of lines. *Bull. Amer. Math.Soc.*, 74:771–792, 1968.
- [13] Charilaos N. Aneziris. *The mystery of knots: computer programming for knot tabulation*. World Scientific Publishers, Singapore; River Edge, N.J., 1999.
- [14] S.A. Argyros, P. Dodos, and V. Kanellopoulos. Unconditional families in banach spaces. *Math. Ann.*, 341:15–38, 2008.
- [15] Alexander Arhangel'skii and Mikhail Tkachenko. *Topological Groups and Related Structures*. Atlantis Press/World Scientific, Amsterdam and Paris, 2008.
- [16] A.V. Arhangel'skii, editor. *General Topology II*. Springer-Verlag, Berlin etc., 1995.
- [17] A.V. Arhangel'skii, editor. *General Topology III*. Springer-Verlag, Berlin etc., 1995.
- [18] A.V. Arkhangel'skiĭ. *Fundamentals of general topology: problems and exercises*. Kluwer, Boston, 1984.
- [19] A.V. Arkhangel'skiĭ. *Topological function spaces*. Kluwer, Boston, 1992.
- [20] A.V. Arkhangel'skiĭ and L.S. Pontryagin, editors. *General Topology I*. Springer-Verlag, Berlin etc., 1990.
- [21] D.L. Armacost. *The structure of locally compact abelian groups*. M. Dekker, New York, 1981.
- [22] M.A. Armstrong. *Basic topology*. Springer-Verlag, New York, 1983.
- [23] V. I. Arnol'd. On functions of three variables. *Dokl. Akad. Nauk.*, 114:679–681; *Amer. Math. Soc. Transl. (2)* **28** (1963), 51–54., 1957.
- [24] V.I. Arnol'd and B.A. Khesin. *Topological methods in hydrodynamics*. Springer, New York, 1999.
- [25] Emil Artin. *Introduction to algebraic topology*. C.E. Merrill Publishing Co., Columbus, Ohio, 1969.

- [26] C.E. Aull and R. Lowen, editors. *Handbook of the history of general topology*. Kluwer Academic Publishers, Dordrecht; Boston, 1997.
- [27] Taras Banakh. *Strongly σ -metrizable spaces are super σ -metrizable*, 2016
<https://arxiv.org/pdf/1611.05351.pdf>.
- [28] Taras Banakh. *Topological spaces with an ω^ω -base*, 2017
<https://arxiv.org/pdf/1607.07978.pdf>.
- [29] Taras Banakh and Arkady Leiderman. *ω^ω -dominated function spaces and ω^ω -bases in free objects of topological algebra*, 2016
<https://arxiv.org/pdf/1611.06438.pdf>.
- [30] Wojciech Banaszczyk. *Additive subgroups of topological vector spaces*. Springer-Verlag, Berlin; New York, 1991.
- [31] J. Banks, J. Brooks, G. Cairns, G. Davis, and P. Stacey. On devaney's definition of chaos. *Amer. Math. Monthly*, 99:332–334, 1992.
- [32] John Banks, Valentina Dragan, and Arthur Jones. *Chaos: A Mathematical Introduction*. Cambridge University Press, Cambridge, UK, 2003.
- [33] Dennis Barden and Charles Benedict Thomas. *Additive subgroups of topological vector spaces*. Imperial College Press, London, 2003.
- [34] Michael Barr. A closed category of reflexive topological abelian groups. *Cahiers de topologie et géométrie différentielle catégoriques*, 18:221–248, 1977.
- [35] Stephen Barr. *Experiments in topology*. Dover Publications, New York, 1989.
- [36] Gerald Alan Beer. *Topologies on closed and convex sets*. Kluwer Academic Publishers, Dordrecht, Boston, 1993.
- [37] Martin P. Bendsoe. *Optimization of structural topology*. Springer, Berlin, New York, 1995.
- [38] Martin P. Bendsoe. *Topology, optimization: theory, methods and applications*. Springer, Berlin, New York, 2003.
- [39] S. Bernstein. Démonstration du théorème de weierstrass fondée sur le calcul des probabilités. *Communications of the Kharkov Mathematical Society*, 13:

1–2, 1912/13

<http://tinyurl.com/nzvhjk5>.

- [40] A. S. Besicovitch. On linear sets of points of fractal dimension. *Math. Annalen*, 101:161–193, 1929.
- [41] Czeslaw Bessaga and Aleksander Pelczynski. *Selected topics in infinite-dimensional topology*. PWN-Polish Scientific Publishers, Warsaw, 1975.
- [42] Jörg Bewersdorff. *Galois theory for beginners: A historical perspective*. American Mathematical Society, Providence, Rhode Island, 2004.
- [43] G.D. Birkhoff and P.A. Smith. Structure analysis of surface transformations. *Jour. Math (Liouville)*, (9) 7:345–379, 1928.
- [44] Bruce Blackadar. A bump in the road to elementary topology, 2018 (2017 preprint)
<https://arxiv.org/abs/1802.04689>.
- [45] Donald W. Blakett. *Elementary topology; a combinatorial and algebraic approach*. Academic Press, New York, 1967.
- [46] Robert L. Blair. The hewitt-pondiczery-marczewski theorem on the density character of a product space. *Archiv der Mathematik*, 23:422–424, 1972.
- [47] Ben Blum-Smith and Samuel Coskey. The fundamental theorem on symmetric polynomials: History's first whiff of Galois theory. *ArXiv.*, 1301.7116v4:16pp, 2016.
- [48] Danail Bonchev and Dennis H. Rouvray, editors. *Chemical topology : introduction and fundamental*. Gordon and Breach, Amsterdam, 1999.
- [49] Armand Borel. *Seminars on transformation groups*. Princeton University Press, Princeton, N.J., 1960.
- [50] Karol Borsuk. *Collected Papers/ Karol Borsuk*. PWN-Polish Scientific Publishers, Warsaw, 1983.
- [51] Nicolas Bourbaki. *General topology v.1 & v.2*. Addison-Wesley, Reading, Mass., 1966.

- [52] Nicolas Bourbaki. *Topologie générale, Chap. 1-4 and Chap. 5-10*. Hermann, Paris, 1971 and 1974.
- [53] Nicolas Bourbaki. *Topological vector spaces*. Springer-Verlag, Berlin ; New York, 1987.
- [54] Jürgen Braun and Michael Griebel. On a constructive proof of kolmogorov's superposition theorem. *Constructive Approximations*, 30:653–675, 2009.
- [55] Glen E. Bredon. *Topology and geometry*. Springer, New York, 1997.
- [56] Michael Brooks. *The quantum astrologer's handbook*. Scribe Publications, Brunswick, Victoria, Australia and London, UK, 2017.
- [57] B. Brosowski and F. Deitsch. An elementary proof of the Stone-Weierstrass Theorem. *Proc. Amer. Math. Soc.*, 81:89–92, 1982.
- [58] Felix E. Browder. ed., *Mathematical Developments Arising from Hilbert Problems, Part 1*. Amer. Math. Soc., Rhode Is., 1976.
- [59] Felix E. Browder. ed., *Mathematical Developments Arising from Hilbert Problems, Part 2*. Amer. Math. Soc., Rhode Is., 1976.
- [60] R. Brown, P.J. Higgins, and Sidney A. Morris. Countable products and sums of lines and circles: their closed subgroups, quotients and duality properties. *Math. Proc. Camb. Philos. Soc.*, 78:19–32, 1975.
- [61] Robert F. Brown. *The Lefschetz fixed point theorem*. Scott, Foresman, Glenview, Ill., 1971.
- [62] Ronald Brown. *Elements of modern topology*. McGraw Hill, New York, 1968.
- [63] Ronald Brown. *Topology : a geometric account of general topology, homotopy types, and the fundamental groupoid*. Halstead Press, New York, 1988.
- [64] Montserrat Bruguera and Mikhail Tkachenko. The three space problem in topological groups. *Topology Applic.*, 153:2278–2302, 2006.
- [65] Donald W. Bryant. *Analysis of Kolmogorov's Superposition Theorem and its Implementation Applications with Low and High Dimensional Data; PhD Dissertation, University of Central Florida, 2008.*

- [66] Georg Cantor. *Contributions to the founding of the theory of transfinite numbers, by Georg Cantor; tr., and provided with an introduction and notes, by Philip E.B. Jourdain.* The Open Court Publishing Company, Chicago, London, 1915.
- [67] Girolamo Cardano. *Ars Magna or the rules of algebra. Translated from Latin into English and edited by T. Richard Witmer of the 1565 edition with additions from the 1570 and 1663 editions.* Dover Publications, Inc., New York, 1993.
- [68] Stephen C. Carlson. *Topology of surfaces, knots, and manifolds: a first undergraduate course.* Wiley, New York, 2001.
- [69] H. Cartan. Théorie des filtres. *C. R. Acad. Paris*, 205:595–598, 1937.
- [70] H. Cartan. Filtrés et ultrafiltrés. *C. R. Acad. Paris*, 205:777–779, 1937.
- [71] H. Cartan and R. Godement. Théorie de la dualité et analyse harmonique dans les groupes abéliens localement compacts. *Ann. Sci. École Norm. Sup*, 64:79–99, 1947.
- [72] J. Scott Carter. *How surfaces intersect in space : an introduction to topology.* World Scientific Publishers, Singapore ; River Edge, N.J., 1995.
- [73] Jesús M.F. Castillo and Manuel González. *Three-space problems in Banach space theory.* Springer., Berlin, Heidelberg etc, 1991.
- [74] Eduard Čech. *Topological spaces.* Czechoslovak Academy of Sciences, Prague, 1966.
- [75] Eduard Čech. *Point sets.* Czechoslovak Academy of Sciences, Prague, 1969.
- [76] M.J. Chasco. Pontryagin duality for metrizable groups. *Arch. Math.*, 70:22–28, 1998.
- [77] M.J. Chasco and X. Domínguez. Topologies on the direct sum of topological abelian groups. *Topology and its applications*, 133:209–223, 2003.
- [78] M.J. Chasco and E. Martín-Peinador. On strongly reflexive topological groups. *Appl. Gen. top.*, 2 (2):219–226, 2001.

- [79] M.J. Chasco, D. Dikranjan, and E. Martin-Peinador. A survey of reflexivity of abelian topological groups. *Topology and its Applications*, 159:2290–2309, 2012.
- [80] Graciela Chichilnisky. *Topology and markets*. American Mathematical society, Providence, R.I., 1999.
- [81] Gustave Choquet. *Topology*. Academic Press, New York, 1966.
- [82] Gustave Choquet. *Lectures on analysis*. W.A. Benjamin, New York, 1969.
- [83] Krzysztof Ciesielski. *Set theory for the working mathematician*. Cambridge University Press, Cambridge, UK, 1997.
- [84] A.H. Clifford and G.B. Preston. *The algebraic theory of semigroups 2nd edition reprinted with corrections*. Amer. Math. Soc., Providence, Rhode Island, 1977.
- [85] Alfred H. Clifford and G.B. Preston. *The algebraic theory of semigroups Vol. II reprinted with corrections*. Amer. Math. Soc., Providence, Rhode Island, 1971.
- [86] Daniel E. Cohen. *Combinatorial group theory: a topological approach*. Cambridge University Press, Cambridge; New York, 1989.
- [87] P.M. Cohn. *Basic algebra: groups, rings and fields*. Springer, New York, 2003.
- [88] W.W. Comfort and S. Negrepointis. *The theory of ultrafilters*. Springer-Verlag, Berlin, New York, 1974.
- [89] W.W. Comfort and S. Negrepointis. *Continuous pseudometrics*. M. Dekker, New York, 1975.
- [90] W.W. Comfort and S. Negrepointis. *Chain conditions in topology*. Cambridge University Press, Cambridge, England; New York, 1982.
- [91] James P. Corbett. *Topological principles in cartography*. US Department of Commerce, Washington, D.C., 1980.
- [92] J.-M. Cordier. *Shape theory: categorical methods of approximation*. Halstead Press, Chichester, England; New York, 1989.

- [93] David A. Cox. Why Eisenstein proved Eisenstein's Criterion and why Schömann discovered it first. *Amer. Math. Monthly*, 118:3–21, 2011.
- [94] Jane Cronin. *Fixed points and topological degree in nonlinear analysis*. American Mathematical Society, Providence, R.I., 1964.
- [95] G. Cybenko. Approximation by superpositions of a sigmoidal function. *Math. Control Signals Systems*, 2:303–314, 1989.
- [96] R.J. Daverman and R.B. Sher, editors. *Handbook of geometric topology*. Elsevier, Amsterdam; New York, 2002.
- [97] B.A. Davey and H.A. Priestley. *Introduction to lattices and order*. Cambridge University Press, Cambridge, 1990.
- [98] H. de Vries. *Compact spaces and compactifications: an algebraic approach*. Van Gorcum, Assen, 1962.
- [99] J.V. Deshpande. *Introduction to topology*. Tata McGraw-Hill Publishing Company Limited, New Delhi, New York, etc., 1988.
- [100] Robert L. Devaney. *Chaos, fractals and dynamics: computer experiments in mathematics*. Addison-Wesley, Menlo Park, California, 1990.
- [101] Robert L. Devaney. *A first course in chaotic dynamical systems: theory and experiment*. Westview Press, Boulder, Colorado, 1992.
- [102] Robert L. Devaney. *An Introduction to Chaotic Dynamical Systems, 2nd Edition*. Westview Press, Boulder, Colorado, 2003.
- [103] Tammo tom Dieck. *Topologie*. de Gruyter, Berlin, 2000.
- [104] Egbert Dierker. *Topological methods in Walrasian economics*. Springer-Verlag, Berlin; New York, 1974.
- [105] Joe Diestel and Angela Spalsbury. *The Joys of Haar Measure*. American Mathematical Society, Providence, Rhode Island, 2014.
- [106] Jean Alexandre Dieudonné. *A history of algebraic and differential topology, 1900-1960*. Birkhauser, Boston, 1989.

- [107] Dikran N. Dikranjan. *Categorical structure of closure operators with applications to topology, algebra and discrete mathematics*. Kluwer Academic Publishers, Dordrecht, Boston, 1995.
- [108] Dikran N. Dikranjan, Ivan R. Prodanov, and Luchezar N. Stoyanov. *Topological Groups: Characters, Dualities, and Minimal Topologies*. Marcel Dekker, Inc., New York, Basel, 1990.
- [109] Mircea V. Diudea and L. Jantschi. *Molecular topology*. Nova Science Publishers, Huntington, N.Y., 2001.
- [110] C.T.J. Dodson. *Category bundles and spacetime topology*. Kluwer Academic Publishers, Dordrecht, Boston, 1988.
- [111] C.T.J. Dodson. *A user's guide to algebraic topology*. Kluwer Academic Publishers, Dordrecht, Boston, 1997.
- [112] Albrecht Dold. *Lectures on algebraic topology*. Springer, Berlin, 1995.
- [113] James Dugundji. *Topology*. Allyn and Bacon, Boston, 1966.
- [114] Heinrich Dörrie. *100 Great Problems of Elementary Mathematics: Their history and solution, translated by David Antin*. Dover Publications, Inc., New York, 1965.
- [115] D. S. Dummit. Solving solvable quintics. *Math. Comp.*, 37:387–401, 1991.
- [116] Alan Dunn. *Sarkovskii's Theorem—Part 1*,
<http://ocw.mit.edu/NR/rdonlyres/Mathematics/18-091Spring--2005/A335FB2E-7381--49D4--B60C--7CBD2F349595/0/sarkcomplete.pdf>, 2005.
- [117] Herbert Edelsbrunner. *Geometry and topology for mesh generation*. Cambridge University Press, Cambridge; New York, 2001.
- [118] Gerald A. Edgar. *Measure, topology and fractal geometry*. Springer-Verlag, New York, 1990.
- [119] Harold Edwards. *Galois Theory*. Springer, Heidelberg, London, Paris, 1984.
- [120] R.E. Edwards. *Curves and topological questions*. Australian National University, Canberra, Australia, 1969.

- [121] Robert E. Edwards. *Functional analysis: theory and applications*. Holt, Rinehart and Winston, N.Y., 1965.
- [122] James Eels. *Singularities of smooth maps*. Gordon and Breach, New York, 1967.
- [123] Samuel Eilenberg and Norman Steenrod. *Foundations of algebraic topology*. Princeton University Press, Princeton, N.J., 1952.
- [124] Murray Eisenberg. *Topology*. Holt, Rinehart and Winston, New York, 1974.
- [125] F.G.M. Eisenstein. Über die Irreduzibilität und einige andere Eigenschaften der Gleichung, von welcher die Theilung der ganzen Lemniscate abhängt. *J. reine und angewandte Math.*, 39:160–179, 1850.
- [126] Patrik Eklund. *Categorical fuzzy topology*. Abo Akademi, Abo, 1986.
- [127] Glenn Elert. *The Chaos Hypertextbook*, <http://hypertextbook.com/chaos/>, 2003.
- [128] P. Enflo. On the invariant subspace problem in Banach spaces. *Séminaire d'analyse fonctionnelle (Polytechnique)*, pages 1–6, 1976
<http://tinyurl.com/gwr3u4n>.
- [129] Per Enflo. A counterexample to the approximation problem in Banach spaces. *Acta mathematica*, 130:309–317, 1973
<http://tinyurl.com/gvfdjho>.
- [130] Ryszard Engelking. *General topology*. PWN – Polish Scientific Publishers, Warsaw, 1977.
- [131] Ryszard Engelking. *Dimension theory*. North-Holland Publishing Co., Amsterdam; New York, 1978.
- [132] Eric W. Weinstein. <http://mathworld.wolfram.com/AxiomofChoice.html>, Accessed, January 2011. From MathWorld—A Wolfram Web Resource.
- [133] William W. Fairchild and Cassius Ionescu Tulceac. *Topology*. W.B. Saunders Company, Philadelphia, London, Toronto, 1971.

- [134] K.J. Falconer. *Fractal geometry: mathematical foundations and applications*. Wiley, Chichester, New York, 1990.
- [135] Erica Flapan. *When topology meets chemistry: a topological look at molecular chirality*. Cambridge University Press, Cambridge; New York, 2000.
- [136] Graham Flegg. *From geometry to topology*. Dover Publications, Mineola, N.Y., 2001.
- [137] John B. Fraleigh. *A first course in abstract algebra*. Pearson Education, Boston, 2002.
- [138] S. P. Franklin. Spaces in which sequences suffice. *Fundamenta Math.*, 57: 107–115, 1965.
- [139] D.H. Fremlin. *Consequences of Martin's Axioms*. Cambridge University Press, Cambridge; New York, 1984.
- [140] Peter Freyd. *Abelian categories: An introduction to the theory of functors*. Harper & Rowe, New York, 1964.
- [141] B. Fridman. An improvement on the smoothness of the functions in kolmogorov's theorem on superpositions. *Dokl. Akad. Nauk. SSSR*, 177:1019–1022; English transl. *Soviet Math. Dokl.* **8** (1967), 1550–1553, 1967.
- [142] Robert Froman. *Rubber bands, baseballs and doughnuts; a book about topology. Illustrated by Harvey Weiss*. Crowell, New York, 1972.
- [143] László Fuchs. *Abelian groups*. Pergamon Press, Edinburgh, 1960.
- [144] Saak Gabrielyan and Jerzy Kąkol. *Free locally convex spaces with a small base*, 2016
<https://arxiv.org/pdf/1604.02555.pdf>.
- [145] Saak Gabrielyan, Jerzy Kąkol, and Arkady Leiderman. On topological groups with a small base and metrizability. *Fundamenta Math.*, 229:129–158, 2015.
- [146] Saak S. Gabrielyan. Minimally almost periodic group topologies on countably infinite abelian groups. *Proc. Amer. Math. Soc.*, 143:1823–1829, 2014.

- [147] P.M. Gadea and J. Munoz Masque. *Analysis and algebra on differentiable manifolds: a workbook for students and teachers*. Kluwer Academic Publishers, Dordrecht, 2001.
- [148] David Gale. The game of hex and the brouwer fixed-point theorem. *Amer. Math. Monthly*, 86:818–827, 1979.
- [149] David B. Gauld. *Differential topology: an introduction*. M. Dekker, New York, 1982.
- [150] Carl Friedrich Gauss. *Disquisitiones Arithmeticae, translated from Latin into English by Arthur A. Clarke*. Yale University Press, New Haven, Connecticut, 1966 (Latin version appeared in 1801).
- [151] I.M. Gelfand and M.A. Naimark. On the embedding of normed rings into the ring of operators on a hilbert space. *Math. Sbornik*, 12:197–217, 1943
<http://tinyurl.com/h3oubks>.
- [152] I.M. Gelfand and D. Raikov. Irreducible unitary representations of locally bicomact groups. *Rec. Math. [Mat. Sbornik] N.S.*, 13:301–316, 1943.
- [153] *General Topology Front for the Mathematics ArXiv*.
<http://front.math.ucdavis.edu/math.gn>, 1992–. Los Alamos National Laboratory e-Print archive.
- [154] Gerhard Gierz, K.H. Hofmann, K. Keimel, J.D. Lawson, M.W Mislove, and D.S. Scott. *A compendium of continuous lattices*. Springer-Verlag, Berlin, Heidelberg, New York, 1980.
- [155] Gerhard Gierz, K.H. Hofmann, K. Keimel, J.D. Lawson, M.W Mislove, and D.S. Scott. *Continuous lattices and domains*. Cambridge University Press, Cambridge, 2003.
- [156] Leonard Gillman and Meyer Jerison. *Rings of continuous functions*. Springer-Verlag, New York, 1976.
- [157] Robert Gilmore and Marc Lefranc. *The topology of chaos: Alice in stretch and squeezeland*. Wiley-Interscience, New York, 2002.

- [158] John Ginsburg and Bill Sands. Minimal infinite topological spaces. *Amer. Math. Monthly*, 86:574–576, 1979.
- [159] Norman J. Girardot. *Myth and Meaning in Early Taoism: The Theme of Chaos (hun-tun)*. University of California Press, Berkeley, California, 1983.
- [160] Helge Glöckner, Ralf Gramlich, and Tobias Hartnick. Final group topologies, kac-moody groups and pontryagin duality. *Israel J. Math.*, 177:49–101, 2010.
- [161] H. Brian Griffiths. *Surfaces*. Cambridge University Press, London; New York, 1976.
- [162] Vasilii A. Gromov. A novel approach to solve nonlinear boundary problems of multilayered thin walled shell theory. *International Journal on Numerical and Analytical Methods in Engineering*, 1:119–122, 2013.
- [163] Jonathan L. Gross. *Topological graph theory*. Wiley, New York, 1987.
- [164] A. Grothendieck. *Topological vector spaces*. Gordon and Breach, New York, 1973.
- [165] Lucye Guilbeau. The history of the solution of the cubic equation. *Mathematics News Letter*, 5:8–12, 1930.
- [166] Charles Robert Hadlock. *Field theory and its classical problems*. Math. Assoc. of America, 1978.
- [167] Marshall Hall Jr. *The theory of groups*. The Macmillan Company, New York, 1959.
- [168] Paul Halmos. *Naive set theory*. Van Nostrand Reinhold Company, New York, Cincinnati, 1960.
- [169] William Rowan Hamilton. Inquiry into the validity of a method proposed by George B. Jerrard, Esq., for transforming and resolving equations of elevated. *British Association for the Advancement of Science August 1836 report, Bristol*, pages 295–348, 1836
<https://www.maths.tcd.ie/pub/HistMath/People/Hamilton/Jerrard/Jerrard.pdf>.

- [170] Rev Robert Harley. A contribution to the history of the problem of the reduction of the general equation of the fifth degree to a trinomial form (with an Appendix on Bring's reduction of the quintic equation. *Quarterly Journal of Pure and Applied Mathematics*, 6:38–47, 1864
[https://babel.hathitrust.org/cgi/pt?id=uc1.\\$b417528;view=1up;seq=52](https://babel.hathitrust.org/cgi/pt?id=uc1.$b417528;view=1up;seq=52).
- [171] Yasunao Hattori. Dimension and superposition of bounded continuous functions on locally compact separable metric spaces. *Topology and its Applic.*, 54:123–132, 1993.
- [172] Felix Hausdorff. Dimension und äußeres maß. *Math. Annalen*, 79:157–159, 1919.
- [173] Felix Hausdorff. *Set Theory (translated from the original German)*. Chelsea, New York, 1962.
- [174] Felix Hausdorff. *Grundzüge der Mengenlehre (reprint; originally published in Leipzig in 1914)*. Chelsea, New York, 1965.
- [175] Torbjörn Hedberg. *The Kolmogorov Superposition Theorem; Appendix 2 in Topics in Approximation Theory. ed. Harold S. Shapiro, Lecture Notes in Math., 187, 267–275*. Springer, Heidelberg, 1971.
- [176] Horst Herrlich. *Axiom of Choice*. Springer Verlag, Berlin, Heidelberg, 2006.
- [177] Horst Herrlich and Hans-E. Porst, editors. *Category theory at work*. Heldermann-Verlag, Berlin, 1991.
- [178] I.N. Herstein. *Noncommutative rings*. Math. Assoc. of America, 1968
<https://doi.org/10.5948/UP09781614440154>.
- [179] Edwin Hewitt. A remark on density characters. *Bull. Amer. Math. Soc.*, 52: 641–643, 1946.
- [180] Edwin Hewitt and Kenneth A. Ross. *Abstract harmonic analysis I: structure of topological groups, integration theory, group representations*. Springer-Verlag, Berlin, 1963.

- [181] Edwin Hewitt and Kenneth A. Ross. *Abstract harmonic analysis II: structure and analysis for compact groups, analysis on locally compact abelian groups*. Springer-Verlag, Berlin, 1970.
- [182] P.J. Higgins. *An introduction to topological groups*. Cambridge University Press, Cambridge, 1974.
- [183] David Hilbert. Über die gleichung neunten grades. *Math. Ann.*, 97:243–250, 1927.
- [184] Joachim Hilgert, Karl Heinrich Hofmann, and Jimmie D. Lawson. *Lie groups, convex cones and semigroups*. Clarendon Press, Oxford, 1997.
- [185] Einar Hille and Ralph S. Phillips. *Functional analysis and semi-groups: revised and expanded edition*. Amer. Math. Soc., Providence, Rhode Island, 1957.
- [186] Peter John Hilton. *Homology theory: an introduction to algebraic topology*. Cambridge University Press, London, 1967.
- [187] Neil Hindman and Dona Strauss. *Algebra in the Stone-Cech compactification : theory and applications*. W. de Gruyter, New York, 1998.
- [188] Morris W. Hirsch, Stephen Smale, and Robert L. Devaney. *Differential Equations, Dynamical Systems, and an Introduction to Chaos, 2nd Edition*. Elsevier, Oxford, UK, 2004.
- [189] John Gilbert Hocking and Gail S. Young. *Topology*. Addison-Wesley Publishing Co., Reading, Mass, 1961.
- [190] Karl H. Hofmann and Sidney A. Morris. *The Lie Theory of Connected Pro-Lie Groups: A Structure Theory for Pro-Lie Algebras, Pro-Lie Groups, and Connected Locally Compact Groups*. European Mathematical Society Publishing House, Tracts in Mathematics 2, Zurich, Switzerland, 2007.
- [191] Karl H. Hofmann and Sidney A. Morris. *The Structure of Compact Groups: A Primer for the Student – A Handbook for the Expert*. de Gruyter, Studies in Mathematics 25, Berlin, third edition, 2013.
- [192] Karl Heinrich Hofmann. Finite dimensional submodules of g -modules for a compact group. *Proc. cambridge Philos. Soc.*, 65:47–52, 1969.

- [193] Karl Heinrich Hofmann and Jimmy Don Lawson. Throwing a glance at 100 volumes of a journal and at half a century of its existence. *Semigroup Forum*, 2019
<https://doi.org/10.1007/s00233-019-10068-3>.
- [194] Karl Heinrich Hofmann and Paul S. Mostert. *Elements of compact semigroups*. C.E. Merrill Books, Columbus, Ohio, 1966.
- [195] *Hopf Topology Archive*. <http://hopf.math.purdue.edu>, 1996–. Purdue University Hopf Archive of Topology preprints.
- [196] Kurt Hornik. Approximation capabilities of multilayer feedforward networks. *Neural Networks*, 4:254–257, 1991.
- [197] Juan Horváth. *Topological vector spaces and distributions*. Addison-Wesley, Reading, Mass., 1966.
- [198] Paul Howard. *Consequences of the Axiom of Choice Project Homepage*, <http://www.math.purdue.edu/~hrubin/JeanRubin/Papers/conseq.html>, 1998 –.
- [199] Paul Howard and Jean Rubin. *Consequences of the Axiom of Choice*. Mathematical Surveys and Monographs 59; American Mathematical Society, Providence, R.I., 1988.
- [200] Norman R. Howes. *Modern analysis and topology*. Springer-Verlag, New York, 1995.
- [201] John M. Howie. *Fundamentals of semigroup theory*. London Mathematical Society Monographs, Clarendon Press, Oxford, 1995.
- [202] S.T. Hu. *Introduction to general topology*. Holden-Day, San Francisco, 1966.
- [203] S.T. Hu. *Differentiable manifolds*. Holt, Rinehart and Winston, New York, 1969.
- [204] Sze-Tsen Hu. *Homotopy Theory*. Academic Press, London, 1959
<http://tinyurl.com/zb4x6q4>.
- [205] Sze-Tsen Hu. *Elements of general topology*. Holden-Day, San Francisco, 1964.

- [206] Sze-Tsen Hu. *Homology theory; a first course in algebraic topology*. Holden-Day, San Francisco, 1966.
- [207] Witold Hurewicz and Witold Wallman. *Dimension theory*. Princeton University Press, Princeton, N.J., 1941.
- [208] Taqdir Husain. *The open mapping and closed graph theorems in topological vector spaces*. Clarendon Press, Oxford, 1965.
- [209] Taqdir Husain. *Introduction to topological groups*. W.B. Saunders, Philadelphia, 1966.
- [210] Taqdir Husain. *Topology and maps*. Plenum Press, New York, 1977.
- [211] Miroslav Husek and Jan Van Mill. *Recent progress in general topology*. North-Holland, Amsterdam; New York, 1992.
- [212] J.R. Isbell. *Uniform spaces*. American Mathematical Society, Providence, R.I., 1964.
- [213] David Asaf IV and Steve Gadbois. Definition of chaos. *Amer. Math. Monthly*, 99:865, 1992.
- [214] Nathan Jacobson. *Structure of rings*. Amer. Math. Soc., Providence, R.I., USA, 1956.
- [215] Nathan Jacobson. *Lectures in Abstract Algebra III. Theory of Fields and Galois Theory*. Springer Verlag, New York, Heidelberg, Berlin, 1964.
- [216] I.M. James. *General topology and homotopy theory*. Springer-Verlag, New York, 1984.
- [217] I.M. James. *Handbook of algebraic topology*. Elsevier, Amsterdam; New York, 1995.
- [218] I.M. James. *Topologies and uniformities*. Springer, London; New York, 1999.
- [219] I.M. James. *History of topology*. Elsevier, Amsterdam; New York, 1999.
- [220] G.B. Jerrard. *An essay on the Resolution of equations*. Taylor and Francis, London, 1859

<https://ia800306.us.archive.org/18/items/essayonresolutio00jerrrich/essayonresolutio00jerrrich.pdf>.

- [221] Arthur Jones, Sidney A. Morris, and Kenneth R. Pearson. *Abstract algebra and famous impossibilities*. Springer-Verlag Publishers, New York, Berlin etc, 1991 & 1993.
- [222] I. Juhász. *Cardinal functions in topology, ten years later*, 1983
<http://oai.cwi.nl/oai/asset/12982/12982A.pdf>.
- [223] J.-P. Kahane. *Séries de Fourier absolument convergentes*. Springer-Verlag, Heidelberg, 1970.
- [224] E. Kamke. *The theory of sets*. Dover, Mineola, New York, 1950.
- [225] V. Kannan. *Ordinal invariants in topology*. American Mathematical Society, Providence, R.I., 1981.
- [226] Shmuel Kantorovitz. *Topics in operator semigroups*. Birkhäuser, Boston, Mass., 2010.
- [227] S. Kaplan. Extensions of pontryagin duality i. *Duke Math. J.*, 15:419–435, 1948.
- [228] S. Kaplan. Extensions of pontryagin duality ii. *Duke Math. J.*, 17:649–658, 1950.
- [229] Irving Kaplansky. *Commutative rings*. The University of Chicago Press, Philadelphia, 1974.
- [230] Irving Kaplansky. *Fields and rings 2nd edition*. The University of Chicago Press, Philadelphia, 1995.
- [231] Christian Kassel. *Quantum groups*. Springer-Verlag, New York, 1995.
- [232] Louis H. Kauffman and Randy A. Baadhio. *Quantum topology*. World Scientific Publishers, Singapore; River Edge, 1993.
- [233] John L. Kelley. *General topology*. Springer-Verlag, New York, 1991.

- [234] Sir William Thomson Lord Kelvin. *The Tides Evening Lecture To The British Association At The Southampton Meeting, 1882*, <http://http://tinyurl.com/zkbrmu5>.
- [235] S.M. Khaleelulla. *Counterexamples in topological vector spaces*. Springer-Verlag, Berlin ; New York, 1982.
- [236] S. Ya. Khavinson. *Best Approximation by Linear Superpositions (Approximate Nomography)*. American Math. Soc. translations of monographs, Providence, R.I., 1996.
- [237] Wan-hui Kim and Robert Tien-wen Chien. *Topological analysis and synthesis of communication networks*. Columbia University Press, New York, 1962.
- [238] Bruce R. King. *Applications of graph theory and topology in inorganic cluster and coordination chemistry*. CRC Press, Boca Raton, Florida, 1993.
- [239] Martin Kleiber and W.J. Pervin. A generalized Banach-Mazur theorem. *Bull. Austral. Math. Soc.*, 1:169–173, 1969
<http://tinyurl.com/ohcwwxg>.
- [240] Felix Klein. Vergleichende Betrachtungen über neuere geometrische Forschungen. *Math. Annalen*, 43:63–100, 1893.
- [241] A.N. Kolmogorov. On the representations of functions of several variables by means of superpositions of continuous functions of a smaller number of variables (russian). *Dokl. Akad. Nauk. SSR*, 108:179–182; Amer. Math. Soc. Transl. (2) **17**(1961), 369–373., 1956.
- [242] A.N. Kolmogorov. On the representations of functions of several variables by means of superpositions of continuous functions of a one variable and addition (russian). *Dokl. Akad. Nauk. SSR*, 114:953–956; Amer. Math. Soc. Transl. (2) 28 (1963), 56–59, 1957.
- [243] T. Yung Kong and Azriel Rosenfeld. *Topological algorithms for digital image processing*. Elsevier, Amsterdam; New York, 1996.
- [244] Gottfried Köthe. *Topological vector spaces*. Springer-Verlag, Berlin ; New York, 1983.

- [245] H. Kuhn. Ein elementarer Beweis des Weierstrasschen Approximationsstzes. *Arch. der Math. (Basel)*, 15:316–317, 1964.
- [246] M. Köppen. *On the training of Kolmogorov's network"*, *ICANN (2002)*, *Lectures Notes in Computer Science* **2415**, 474–479. Springer, Heidelberg, 2002.
- [247] Kenneth Kunen. *Set theory*. North-Holland, Amsterdam, 1980.
- [248] Kenneth Kunen and Jerry E. Vaughan, editors. *Handbook of set-theoretic topology*. North-Holland, Amsterdam, 1984.
- [249] Kazimierz Kuratowski. *Introduction to set theory and topology*. Pergamonn Press, New York, 1961.
- [250] A. G. Kurosh. *Theory of Groups: Volume 1*. AMS Chelsea Publishing, New York, 1956; Reprinted 1960.
- [251] N.P. Landsman. *Lecture notes on C^* algebras and quantum mechanics*, 1998
<http://tinyurl.com/zxsg54u>.
- [252] Serge Lang. *Real and functional analysis, third edition*. Springer-Verlag, Berlin, Heidelberg, 1993
<http://tinyurl.com/zmxpfmv>.
- [253] H.A. Lauwerier. *Fractals: endlessly repeated geometrical figures*. Princeton University Press, Princeton, N.J., 1991.
- [254] John M. Lee. *Introduction to topological manifolds*. Springer, New York, 2000.
- [255] John M. Lee. *Introduction to smooth manifolds*. Springer, New York, 2002.
- [256] Arkady G. Leiderman, Sidney A. Morris, and Vladimir Pestov. Free abelian topological groups and the free locally convex space on the unit interval. *J. London Math. Soc.*, 56:529–538, 1997.
- [257] Arkady G. Leiderman, Vladimir G. Pestov, and Artur H. Tomita. *Topological groups admitting a base at identity indexed with ω^ω* , 2016
<https://arxiv.org/pdf/1511.07062.pdf>.

- [258] H. Leptin. Zur dualitätstheorie projectiver limites abelscher gruppen. *Abh. Math. Sem. Univ. Hamburg*, 19:264–268, 1955.
- [259] Michael Levin. Dimension and superposition of continuous functions. *Israel J. Math.*, 70:205–218, 1990.
- [260] N. Levine. Semi-open sets and semi-continuity in topological spaces. *Amer. Math. Monthly*, 70:36–41, 1963.
- [261] Huaxin Lin. *An introduction to the classification of amenable C^* -algebras*. World Scientific, London, Singapore, 2001.
- [262] Seymour Lipschutz. *Schaum's outline of general topology*. McGraw Hill, 1968.
- [263] Ying-ming Liu and Mao-kang Luo. *Fuzzy topology*. World Scientific Publishers, River Edge, N.J., 1997.
- [264] Charles Livingston. *Knot theory*. The Mathematical association of America, 1993.
- [265] George G. Lorentz. Metric entropy, widths, and superpositions of functions. *Amer. Math. Monthly*, 69:469–485, 1962.
- [266] George G. Lorentz. *Approximation of Functions*. Holt, Rinehart and Winston, New York, 1966.
- [267] E.N. Lorenz. Deterministic nonperiodic flow. *Journal of the Atmospheric Sciences*, 20:130–141, 1963.
- [268] Ian D. Macdonald. *The theory of Groups*. Oxford University Press, Oxford, 1968 <http://tinyurl.com/h47qwe3>.
- [269] Saunders MacLane. *Categories for the working mathematician, second edition*. Springer-Verlag, New York, 1998.
- [270] Saunders MacLane and Garrett Birkhoff. *Algebra*. Chelsea Publishing Company, New York, 1988.
- [271] I.J. Maddox. *Elements of functional analysis, second edition*. Cambridge Univ. Press, Cambridge, 1988 <http://tinyurl.com/pwyeelq>.

- [272] Wilhelm Magnus, Abraham Karrass, and Donald Solitar. *Combinatorial group theory 2nd revised edition*. Dover Publications Inc., New York, 1976.
- [273] Benoit B. Mandelbrot. How long is the coast of Britain? statistical self-similarity and fractional dimension. *Science*, 155:636–638, 1967.
- [274] Benoit B. Mandelbrot. *The fractal geometry of nature*. W.H. Freeman, New York, 1983.
- [275] Mark Mandelkern. A short proof of the Tietze-Urysohn extension theorem. *Arch. Math.*, 60:364–366, 1993.
- [276] Edward Marczewski. Séparabilité et multiplication cartésienne des espaces topologiques. *Fundamenta Math.*, 34:137–143, 1947.
- [277] Per Martin-Löf. *100 years of Zermelo's axiom of choice: What was the problem with it?, in Logicism, Intuitionism, and Formalism: What Has Become of Them?, Sten Lindström, Erik Palmgren, Krister Segerberg, and Viggo Stoltenberg-Hansen editors*. Springer, London, 2009.
- [278] R.D. Mauldin, editor. *The Scottish Book: Mathematics from the Scottish Café*. Birkhäuser, Boston, 1981.
- [279] Robert M. May. Biological populations with nonoverlapping generations: Stable points, stable cycles, and chaos. *Science*, 186:645–647, 1974.
- [280] George McCarty. *Topology; an introduction with application to topological groups*. McGraw Hill, New York, 1967.
- [281] Robert A. McCoy and Ibulu Ntantu. *Topological properties of spaces of continuous functions*. Springer-Verlag, New York, Berlin, 1988.
- [282] Dusa McDuff and Dietmar Salamon. *Introduction to symplectic topology*. Oxford University Press, New York, 1998.
- [283] Richard E. Merrifield and Howard E. Simmons. *Topological methods in chemistry*. Wiley, New York, 1989.
- [284] Emil G. Milewski. *The topology problem solver: a complete solution guide to any textbook*. Research and Education Association, Piscataway, N.J., 1994.

- [285] M. Mimura and Hirosi Toda. *Topology of Lie groups*. American Mathematical Society, Providence, R.I., 1991.
- [286] Edward E. Moise. *Introductory problem courses in analysis and topology*. Springer-Verlag, New York, 1982.
- [287] Mikhail I. Monastyrskaei. *Topology of gauge fields and condensed matter*. Plenum Press, New York, 1993.
- [288] Deane Montgomery and Leo Zippin. *Topological transformation groups*. Interscience Publishers, New York, 1955.
- [289] E.H. Moore and H.L. Smith. A general theory of limits. *American Journal of Mathematics*, 44:102–121, 1922.
- [290] Robert L. Moore. *Foundations of point set topology*. American Mathematical Society, Providence, R.I., 1962.
- [291] Giuseppe Morandi. *The role of topology in classical and quantum physics*. Springer-Verlag, Berlin, New York, 1992.
- [292] K. Morita and J. Nagata, editors. *Topics in general topology*. North Holland, Amsterdam, 1989.
- [293] Sidney A. Morris. *Pontryagin duality and the structure of locally compact abelian groups*. Cambridge University Press, Cambridge; New York, 1977.
- [294] Sidney A. Morris. On somewhat divisible groups. *Bull. Institute Mathematics Academia Sinica*, 9:35–37, 1981.
- [295] Sidney A. Morris. Varieties of topological groups ... a survey. *Colloquium Mathematicum*, 46:147–165, 1982
<http://tinyurl.com/zwpssww>.
- [296] Sidney A. Morris. Are finite topological spaces worthy of study. *Austral. Math. Soc. Gazette*, 11:31–32, 1984.
- [297] Sidney A. Morris. An elementary proof that the Hilbert cube is compact. *Amer. Math. Monthly*, 91:563–564, 1984.

- [298] Sidney A. Morris, editor. *Topological Groups: Yesterday, Today, Tomorrow*. MDPI, Basel, Switzerland, 2016
<http://tinyurl.com/hc5th7g>.
- [299] Jan Mycielski. Some properties of connected compact groups. *Colloq. Math.*, 5:162–166, 1958.
- [300] Jan Mycielski. A system of axioms of set theory for the rationalists. *Notices Ameri. Math. Soc.*, 53 (2):209, 2006.
- [301] Gregory L. Naber. *Topological methods in Euclidean spaces*. Cambridge University Press, Cambridge, New York, 1980.
- [302] Gregory L. Naber. *Topology, geometry and gauge fields: foundations*. Springer, New York, 1997.
- [303] Keio Nagami. *Dimension theory*. Academic Press, New York, 1970.
- [304] Jun-iti Nagata. *Modern dimension theory*. Interscience Publishers, New York, 1965.
- [305] Jun-iti Nagata. *Modern general topology*. North Holland Publishing Company, Amsterdam, 1985.
- [306] M.A. Naimark. *Normed Rings*. P. Noordhoff, 1959.
- [307] Mikio Nakahara. *Geometry, topology and physics*. A. Hilger, Bristol, England; New York, 1990.
- [308] H. Nakano. *Topology and linear topological spaces*. Maruzen Co., Tokyo, 1951.
- [309] Lawrence Narici and Edward Beckenstein. *Topological vector spaces*. M. Dekker, New York, 1985.
- [310] Charles Nash. *Topology and geometry for physicists*. Academic Press, London, New York, 1983.
- [311] Hanna Neumann. *Varieties of groups*. Springer-Verlag, New York, 1967.
- [312] Peter M. Neumann. *The mathematical writings of Évariste Galois*. European Mathematical Society, Zürich, 2010.

- [313] M.H.A. Newman. *Elements of the topology of plane sets of points*. Greenwood Press, Westport, Conn., 1985.
- [314] Sir Isaac Newton. *Universal arithmetick: or, A treatise of arithmetical composition and resolution an English translation of Arithmetic Universalis published in Latin in 1707*. London, 1769.
- [315] Peter Nickolas. Reflexivity of topological groups. *Proc. Amer. Math. Soc.*, 65: 137–141, 1977.
- [316] Peter Nickolas. Coproducts of abelian topological groups. *Topology and its Applications*, 120:403–426, 2002.
- [317] Ivan Niven. *Numbers: Rational and Irrational*. The L.W. Singer Company, Connecticut, 1961
<http://users.auth.gr/siskakis/Niven-NumbersRationalAndIrrational.pdf>.
- [318] N. Noble. k -groups and duality. *Trans. Amer. Math. Soc.*, 151:551–561, 1970.
- [319] A.L. Onishchik. *Topology of transitive transformation groups*. Johann Ambrosius Barth, Leipzig, 1994.
- [320] P. A. Ostrand. Dimension of metric spaces and hilbert's problem 13. *Bull. Amer. Math. Soc.*, 71:619–622, 1965.
- [321] John C. Oxtoby. *Measure and category; a survey of the analogies between topological and measure spaces*. Springer-Verlag, New York, 1971.
- [322] A.R. Pears. *Dimension Theory of general spaces*. Cambridge University Press, Cambridge, New York, 1975.
- [323] Anthony L. Peressini. *Ordered topological vector spaces*. Harper and Row, New York, 1967.
- [324] Vladimir Pestov. Free abelian topological groups and pontryagin-van kampen duality. *Bull. Austral. Math. Soc.*, 52:297–311, 1995.
- [325] Les A. Piegl. *Fundamental developments of computer-aided geometric modeling*. Academoc Press, 1993.

- [326] C.G.C. Pitts. *Introduction to metric spaces*. Oliver and Boyd, Edinburgh, 1972.
- [327] Wolfram Pohlers. *Proof theory: an introduction*. Springer, Berlin, 1989.
- [328] Henri Poincarè. *Science and method; translated and republished*. Dover Press, New York, 2003.
- [329] E.S. Pondiczery. Power problems in abstract spaces. *Duke Math. J.*, 11: 835–837, 1944.
- [330] L.S. Pontryagin. *Topological Groups*. Princeton University Press, Princeton, 1946.
- [331] Ian R. Porteous. *Topological geometry*. Cambridge University Press, Cambridge, England, New York, 1981.
- [332] Victor V. Prasolov. *Polynomials*. Springer, Heidelberg, New York, 2004.
- [333] Gavriil Păltineanu. Some applications of bernoulli's inequality in the approximation theory. *Romanian J. Math. Comp. Sc.*, 4:1–11, 2014.
- [334] Bodo von Querenburg. *Mengentheoretische Topologie*. Springer-Verlag, Berlin, 2001.
- [335] D.A. Raikov. Harmonic analysis on commutative groups with haar measure and the theory of characters (russian with english abstract). *Trudy Mat. Inst. Steklov.*, 14:1–86, 1945.
- [336] George M. Reed. *Surveys in general topology*. Academic Press, New york, 1980.
- [337] G.M. Reed, A.W. Roscoe, and R.F. Wachter. *Topology and category theory in computer science*. Oxford University Press, Oxford, England, 1991.
- [338] Dieter Remus. Topological groups with no non-trivial characters. *In: General Topology and its relations to modern analysis and algebra VI (Z. Frolík ed) Proc. Sixth 1986 Prague Topological Symposium*, pages 477–484, 1988.
- [339] Renzo L. Ricca. *An introduction to the geometry and topology of fluid flows*. Kluwer Academic Publishers, Dordrecht; Boston, 2001.

- [340] David S. Richeson. *Euler's gem: The polyhedron formula and the birth of topology*. Princeton University Press, Princeton, New Jersey, 2008.
- [341] A.P. Robertson and Wendy Robertson. *Topological vector spaces*. Cambridge University Press, Cambridge, England, 1973.
- [342] Derek J. Robinson. *A course in the theory of groups, second edition*. Springer-Verlag, New York, 1996.
- [343] D.W. Roeder. Category theory applied to pontryagin duality. *Pacific J. Math.*, 52:519–527, 1974.
- [344] Judith Roitman. *Introduction to modern set theory*. Virginia Commonwealth University Mathematics, Virginia, 2011.
- [345] Michael I. Rosen. Niels Hendrik Abel and equations of the fifth degree. *Amer. Math. Monthly.*, 102:495–505, 1995.
- [346] Kenneth A. Ross. Closed subgroups of compactly generated lca groups are compactly generated. *Topology and its Applic.*, 259:378–383, 2019.
- [347] Joseph J. Rotman. *An introduction to algebraic topology*. Springer-Verlag, New York, 1988.
- [348] Herman Rubin and Jean E. Rubin. *Equivalents of the Axiom of Choice*. North Holland, 1963.
- [349] Herman Rubin and Jean E. Rubin. *Equivalents of the Axiom of Choice II*. North Holland/Elsevier, 1985.
- [350] Mary-Ellen Rudin. A normal space x for which $x \times i$ is not normal. *Bull. Amer. Math. Soc.*, 77:246, 1971.
- [351] Mary Ellen Rudin. *Lectures on set theoretic topology*. American Mathematical Society, Providence, R.I., 1975.
- [352] Walter Rudin. *Principles of Mathematical analysis, third edition*. Mc Graw Hill, New York etc, 1964
<http://tinyurl.com/peudmtw>.

- [353] Walter Rudin. *Fourier Analysis on Groups*. Interscience Publishers, John Wiley & Sons, New York, London, Sydney, 1967.
- [354] Walter Rudin. *Functional analysis, second edition*. Mc Graw Hill, New York etc, 1991
<http://tinyurl.com/zj3ohkw>.
- [355] Hans Sagan. *Space-filling curves*. Springer-Verlag, New York, 1994.
- [356] A.N. Sarkovskii. Coexistence of cycles of a continuous map of a line into itself. *Ukranian Mat. Z.*, 16:61–71, 1964.
- [357] T. Schönemann. Von denjenigen Moduln, welche Potenzen von Primzahlen sind. *J. reine und angewdte Math.*, 32:93–105, 1846.
- [358] D. B. Shakhmatov. Cardinal invariants of topological fields (english transl. from soviet math. dokl. 28 (1983) 209–294). *Dokl. Akad. Nauk SSSR*, 271: 1332–1336, 1983.
- [359] Saharon Shelah. On a problem of Kurosh, Jonsson groups, and applications. *Word problems II, Stud. Logic Found. Math.*, 995:373–394, 1980.
- [360] S.J. Sidney. Weakly dense subgroups of Banach spaces. *Indiana Univ. Math.J.*, 26:981–986, 1977.
- [361] M. Signore and F. Melchiorri. *Topological defects in cosmology*. World Scientific Publishers, Singapore, 1998.
- [362] George E. Simmons. *Introduction to topology and modern analysis*. McGraw Hill, New York, 1963.
- [363] Barry Simon. *Tales of our forefathers*
<http://tinyurl.com/hr4cq3c>.
- [364] I.M. Singer. *Lecture notes on elementary topology and geometry*. Springer-Verlag, New York, 1967.
- [365] Christopher G. Small. *The statistical theory of shape*. Springer, New York, 1996.

- [366] M.F. Smith. The pontryagin duality theorem in linear spaces. *Ann. of Math.*, (2) 56:248–253, 1952.
- [367] Alexei Sossinsky. *Knots: mathematics with a twist*. Harvard University Press, 2002.
- [368] Edwin H. Spanier. *Algebraic topology*. Springer-Verlag, New York, 1966.
- [369] Blair K. Spearman and Kenneth S. Williams. Characterization of solvable quintics $x^5 + ax + b$. *Amer. Math. Monthly*, 101:986–992, 1994.
- [370] Michael Spivak. *Calculus on manifolds*. Addison-Wesley, Reading, Massachusetts, 1965.
- [371] David A. Sprecher. An improvement in the superposition theorem of Kolmogorov. *Journal of Mathematical Analysis and Applications*, 38:208–213, 1972.
- [372] David A. Sprecher. A numerical implementation of kolmogorov's superpositions. *Neural networks*, 9:765–772, 1996.
- [373] David A. Sprecher. A numerical implementation of kolmogorov's superpositions II. *Neural networks*, 10:447–457, 1997.
- [374] John R. Stallings. *Lectures on polyhedral topology*. Tata Institute of Fundamental research, Bombay, India, 1967.
- [375] Lynn Arthur Steen and J. Arthur Seebach Jr. *Counterexamples in topology*. Holt, Rinehart and Winston, New York, 1970.
- [376] N.E. Steenrod. *Reviews of papers in algebraic and differential topology, topological groups and homological algebra*. American Mathematical Society, Providence, R.I., 191968.
- [377] N.E. Steenrod. *The topology of fibre bundles*. Princeton University Press, Princeton, N.J., 1951.
- [378] Y. Sternfeld. Superpositions of continuous functions. *J. Approximation Theory*, 25:360–368, 1979.

- [379] Y. Sternfeld. Dimension, superposition of functions and separation of points in compact metric spaces. *Israel J. Math.*, 50:13–53, 1985.
- [380] Y. Sternfeld. *Hilbert's 13th problem and dimension; in J. Lindenstrauss and V. D. Milman editors, Geometric aspects of functional analysis, Lecture Notes in Mathematics 1376, pp. 1–49.* Springer, Berlin, 1989.
- [381] Ian Stewart. *Galois theory, third edition.* Chapman and Hall, London, 2004.
- [382] Ian Stewart. *Significant: Lives and works of trailblazing mathematicians.* Profile Books, London, 2017.
- [383] John Stillwell. *Classical topology and combinatorial group topology.* Springer-Verlag, New York, 1995.
- [384] M.H. Stone. Applications of the theory of boolean rings to general topology. *Trans. Amer. Math.Soc.*, 41(3):375–481, 1937.
- [385] M.H. Stone. The generalized weierstrass approximation theorem. *Mathematics Magazine*, 21(4):167–184, 1937.
- [386] Markus Stroppel. *Locally compact groups.* European Mathematical Society Publishers, Zurich, 2006.
- [387] B. Sury. Weierstrass's theorem - leaving no Stone unturned. *Resonance*, : 341–355, 2011
<http://www.isibang.ac.in/~sury/hyderstone.pdf>.
- [388] Andrew Szanton. *The recollections of Eugene P. Wigner as told to Andrew Szanton.* Plenum, 1992.
- [389] Terrence Chi-Shen Tao. *Hilbert's Fifth Problem and Related Topics.* American Mathematical Society, Providence, R.I., 2014
<http://tinyurl.com/9a4ofdu>.
- [390] *The MacTutor History of Mathematics Archive.*
<http://www-gap.dcs.st-and.ac.uk/~history/>, 2001–.
- [391] Wolfgang Thron. *Topological structures.* Holt, Rinehart and Winston, New York, 1966.

- [392] *Topology*. <http://www.elsevier.com/locate/top>, 1962–. A hard-copy refereed research journal in topology and geometry.
- [393] *Topology and its Applications*. <http://www.elsevier.nl/locate/topol>, 1971–. A hard-copy refereed research journal in topology.
- [394] *Topology Atlas*. <http://at.yorku.ca/topology>, 1995–. Topology related resources.
- [395] *Topology Proceedings*.
<http://topology.auburn.edu/tp/>, 1977–. A hard-copy refereed research journal.
- [396] H. Toruńczyk. Characterizing Hilbert space topology. *Fundamenta Math.*, 111:247–262, 1981.
- [397] E.R. van Kampen. Locally bicomact abelian groups and their character groups. *Ann. of Math.*, (2) 36:448–463, 1935.
- [398] J. van Mill. *The infinite-dimensional topology*. North Holland, Amsterdam, Oxford, Tokyo, 1988.
- [399] J. van Mill. *The infinite-dimensional topology of function spaces*. Elsevier, Amsterdam, New York, 2001.
- [400] Jan van Mill and George M. Reed. *Open problems in topology*. North-Holland, Amsterdam, 1990.
- [401] N.Th. Varopoulos. Studies in harmonic analysis. *Proc. Camb. Philos. Soc.*, 60:465–516, 1964.
- [402] Michel Vellekoop and Raoul Berglund. On intervals, transitivity = chaos. *Amer. Math. Monthly*, 101:353–355, 1994.
- [403] R. Venkataraman. Extensions of pontryagin duality. *Math. Z.*, 143:105–112, 1975.
- [404] Steven Vickers. *Topology via logic*. Cambridge University Press, Cambridge, 1990.
- [405] N.Ya. Vilenkin. The theory of characters of topological abelian groups with boundedness given. *Izv. Akad. Nauk. SSSR. Ser. Mat.*, 15:439–462, 1951.

- [406] A. G. Vitushkin. On hilbert's thirteenth problem (russian). *Dokl. Akad. Nauk SSSR*, 96:701–704, 1954.
- [407] A. G. Vitushkin. On hilbert's thirteenth problem and related questions. *Russian Math. Surveys*, 59:11–25, 2004.
- [408] A.V. Vologodskii. *Topology and physics of circular DNA*. CRC Press, Boca Raton, 1992.
- [409] J. von Neumann. Zur einföhrung der transfiniten zahlen. *Acta litt. Acad. Sc. Szeged*, X.1:199–208, 1923.
- [410] J. von Neumann. Eine widerspruchsfreiheitsfrage in der axiomatischen mengenlehre. *Crelle*, 160:227, 1929.
- [411] John von Neumann. Almost periodic functions in a group i. *Trans. Amer. Math. Soc.*, 36:445–492, 1934.
- [412] John von Neumann and Eugene Paul Wigner. Minimally almost periodic groups. *Annals of Math. (series 2)*, 41:746–750, 1940.
- [413] Ehrenfried Walther von Tschirnhaus. A method for removing all intermediate terms from a given equation. *Acta Eruditorum*, pages 204–207
Translated into English by R.F. Green and republished in ACM SIGSAM Bulletin (37) 2003, 1–3., 1683.
- [414] Rudolf Výborný. The weierstrass theorem on polynomial approximation. *Mathematica Bohemica*, 130:161–166, 2005.
- [415] Russell C. Walker. *The Stone-Cech compactification*. Springer-Verlag, Berlin; New York, 1974.
- [416] C.T.C. Wall. *A geometric introduction to topology*. Addison-Wesley, Reading, Mass., 1972.
- [417] A.D. Wallace. *Differential topology; first steps*. W.A. Benjamin, New York, 1968.
- [418] H. Wallmani. Lattices and topological spaces. *Ann. of Math.*, 39:112–126, 1938.

- [419] Evert Wattel. *The compactness operator in set theory and topology*. Mathematisch Centrum, Amsterdam, 1968.
- [420] Jeffrey R. Weeks. *The shape of space*. Marcel Dekker, New York, 2002.
- [421] A. Weil. *L'integration dans les groupes topologiques et ses applications*. Hermann & Cie., Paris, 1951.
- [422] Hermann Weyl and F. Peter. Die vollständigkeit der primitiven darstellungen einer geschlossenen kontinuierlichen gruppe. *Math. Ann.*, 97:737–755, 1927.
- [423] Stuart G. Whittington, De Witt Sumners, and Timothy Lodge, editors. *Topology and geometry in polymer science*. Springer, New York, 1998.
- [424] R.L. Wilder. *Topology of manifolds*. Amer. Math. Soc. Colloquium Publ., RI, USA, vol. 32, 1979.
- [425] John S. Wilson. *Profinite groups*. Clarendon Press, Oxford, UK, 1988.
- [426] Robin Wilson. *Four colors suffice: how the map problem was solved*. Princeton University Press, Princeton, N.J., 2003.
- [427] James Yorke and T-Y. Li. Period three implies chaos. *Amer. Math. Monthly*, 82:985–992, 1975.

Index

- [0, 1], [263](#), [264](#), [274](#), [275](#), [300](#), [301](#), [327](#),
[332](#), [335](#)
- ω^ω -base, [313](#)
- \aleph_0 , [394](#)
- abelain, [526](#)
- abelian group, [493](#)
 - torsion-free, [532](#)
- absolutely convex, [209](#)
- absolutely convex set, [209](#)
- absorbent set, [209](#)
- AC, [632](#)
- accumulation point, [73](#)
- Acta Arithmetica, [434](#)
- adjoint, [388](#)
- Alaoglu, Leonidas, [316](#)
- Alexander Subbasis Theorem, [179](#)
- algebra
 - C^* -, [388](#)
 - associative, [376](#)
 - Banach, [377](#)
 - commutative, [376](#)
 - normed, [377](#)
 - unital, [376](#)
- algebra over a field, [376](#)
- algebraic number, [398](#)
- almost connected, [601](#), [607](#)
- almost-periodic functions, [599](#)
- analytic
 - set, [433](#)
- analytic function, [366](#)
- analytic set, [154](#)
- annihilator, [320](#), [601](#), [610](#)
- antisymmetric binary relation, [265](#), [378](#)
- arrow, [110](#)
- Ascoli's Theorem, [554](#)
- Asplund space, [324](#)
- Asplund, Edgar, [324](#)
- associative algebra, [376](#)
- attracting fixed point, [442](#)
- attracting periodic point, [452](#)
- axiom
 - least upper bound, [85](#)
- Axiom of Choice, [269](#), [631](#), [632](#)
- B^n , [344](#)
- Bézier curves, [364](#)
- Bézierr, Pierre, [364](#)
- Baire Category Theorem, [164](#), [165](#)
 - for Locally Compact Spaces, [534](#)
- Baire space, [165](#)
- Baire, René Louis, [426](#)
- balanced, [210](#)
- ball

- closed unit, [187](#)
- Banach
 - Fixed Point Theorem, [162](#)
- Banach algebra, [377](#)
- Banach space, [158](#), [265](#), [525](#)
 - compactly generated, [208](#)
 - reflexive, [315](#), [321](#), [322](#)
 - separable, [159](#), [208](#), [319](#)
 - separable dual, [319](#)
 - weakly compactly generated, [322](#)
- Banach space dual
 - reflexive, [321](#)
- Banach, Stefan, [316](#), [317](#), [427](#)
- Banach-Alaoglu Theorem, [316](#), [322](#)
- Banach-Mazur Theorem, [386](#)
- Banach-Tarski paradox, [427](#)
- Banachiewicz, Tadeusz, [432](#)
- base
 - filter, [640](#)
 - ultrafilter, [648](#)
- basis, [57](#), [544](#)
 - filter, [640](#)
 - ultrafilter, [648](#)
- Battista, Leon, [488](#)
- Bernoulli, Jacob, [354](#)
- Bernstein base polynomials, [308](#)
- Bernstein polynomial, [309](#), [363](#)
- Besicovitch
 - Abram Samoilovitch, [470](#)
- bifurcation, [452](#)
 - period doubling, [453](#)
- Bifurcation Theorem
 - First, [452](#)
- bijection, [393](#)
- bijjective, [41](#)
- bikompakt, [192](#)
- binary relation
 - antisymmetric, [265](#), [378](#)
 - reflexive, [97](#), [265](#), [378](#)
 - symmetric, [97](#)
 - transitive, [97](#), [265](#), [378](#)
- Birkhoff
 - George David, [462](#)
- Bohr compactification, [599](#)
- Bolzano-Weierstrass Theorem, [151](#)
- bound
 - greatest lower, [85](#), [379](#)
 - least upper, [379](#)
 - lower, [85](#), [379](#)
 - upper, [85](#), [268](#), [269](#), [379](#)
- boundary, [164](#)
- boundary point, [164](#)
- bounded, [85](#), [183](#)
 - above, [85](#)
 - below, [85](#)
 - metric, [134](#)
 - metric space, [134](#)
 - set, [160](#)
- bounded linear functional, [316](#)
- bounded linear operator, [316](#)
- bounded subset of a poset, [312](#)
- box topology, [225](#)
- Brouwer Fixed Point Theorem, [120](#)
- Brouwer, Luitzen Egbertus Jan, [428](#)
- Brunelleschi, Filippo, [488](#)
- bump function, [370](#)

- butterfly effect, [461](#)
- $(C(X), F)$, [370](#)
- $(C(X), \mathbb{C})$, [370](#)
- $(C(X), \mathbb{R})$, [370](#)
- $C[0, 1]$, [68](#), [126](#), [127](#), [187](#), [365](#)
- C^* -algebra, [388](#)
- \mathfrak{c} , [406](#)
- c_0 , [136](#), [159](#)
- C^∞ , [367](#)
- CAD, [364](#)
- Café, Scottish, [427](#)
- Cantor
 - Georg, [401](#)
- Cantor set, [222](#)
- Cantor Space
 - middle two-thirds, [248](#)
- Cantor space, [222](#)
- Cantor, Georg, [432](#)
- card , [406](#)
- cardinal function, [312](#)
- cardinal invariant, [312](#)
- cardinal number, [406](#)
- cardinality, [394](#)
- carpet
 - Sierpiński, [433](#)
- Cartan, Élie, [506](#)
- cartesian product, [260](#), [300](#)
- category
 - first, [166](#)
 - second, [166](#)
- Cauchy sequence, [148](#)
- Cauchy-Riemann
 - manifold, [140](#)
- cellularity, [312](#)
- centre, [526](#)
- $cf(P)$, [312](#)
- chaos, [455](#), [470](#)
- chaotic dynamical system, [463](#)
- character, [556](#)
- character group, [556](#)
- Church-Kleene ordinal, [423](#)
- circle group, [493](#)
- Clebsch, Rudolf Friedrich Alfred, [485](#)
- clopen
 - set, [36](#)
- closed
 - mapping, [186](#), [198](#), [340](#)
 - sequentially, [146](#)
 - set, [34](#)
 - unit ball, [187](#)
- closure, [77](#)
- cluster point, [73](#)
- cluster point of filterbase, [643](#)
- cluster point of net, [655](#)
- coarser, [622](#)
- coarser filterbasis, [641](#)
- coarser topology, [116](#), [198](#)
- coarsest topology, [261](#)
- cofinal, [312](#), [654](#)
- cofinality of a poset, [312](#)
- cofinally, [650](#)
- cofinite topology, [39](#)
- coinital, [312](#)
- collectionwise Hausdorff, [245](#)
- commutative algebra, [376](#)

- commutator, [510](#)
- commutator group, [510](#)
- commutator subgroup, [526](#), [533](#)
- compact, [176](#), [177](#), [265](#), [272–274](#), [277](#), [279](#), [284](#), [299](#), [326](#), [631](#), [646](#)
 - countably, [189](#), [190](#)
 - relatively, [188](#)
 - sequentially, [190](#)
 - space, [177](#)
 - weak*-, [316](#)
- compact element, [608](#)
- compact Lie group, [496](#)
- compact space, [646](#)
- compact-open topology, [552](#)
- compactification
 - Bohr, [599](#)
 - Stone-Čech, [326](#), [329–332](#), [335](#)
 - Wallman, [665](#)
- compactly generated, [522](#), [582](#)
- compactly generated Banach space, [208](#)
- compactly-generated space, [303](#)
- compactum, [215](#)
- comparable
 - textbf, [268](#)
- complete, [149](#)
- completely metrizable, [153](#)
- completely regular, [274](#), [276](#), [300](#)
- completely regular space, [275](#)
- completion
 - of a metric space, [155](#)
- complex trigonometric polynomial, [385](#)
- component, [121](#), [213](#), [215](#), [523](#), [526](#)
 - identity, [508](#)
- Compositio Mathematica, [430](#), [434](#)
- cone, [343](#)
 - reduced, [347](#)
- conjugate dynamical systems, [466](#)
- conjugate map, [466](#)
- connected, [86](#), [298](#), [301](#)
 - almost, [601](#), [607](#)
 - component, [213](#)
 - locally, [216](#), [252](#)
 - manifold, [140](#)
 - path, [118](#)
 - pathwise, [118](#)
- connected topological group, [522](#)
- continuous, [110](#)
 - at a point, [170](#)
 - homomorphism, [519](#)
 - jointly, [552](#)
 - sequentially, [147](#)
- continuous homomorphism, [519](#)
- continuous mapping, [112](#)
- continuum, [215](#)
- contraction
 - mapping, [161](#)
- Contraction Mapping Theorem, [162](#)
- contradiction, [53](#)
- converge, [141](#), [190](#), [642](#), [650](#)
- converge, [628](#)
- convergent
 - pointwise, [365](#)
- convergent filterbase, [642](#)
- convergent sequence, [190](#)
- Converse of Heine-Borel Theorem, [183](#)
- convex

- set, [167](#)
 - absolutely, [209](#)
- convex set, [209](#)
- Coolidge, Julian Lowel, [485](#)
- coordinates
 - homogeneous, [491](#)
- cosmic space, [247](#)
- countability
 - first axiom of, [137](#)
 - second axiom of, [62](#)
- countable
 - second, [241](#)
- countable bases, [137](#)
- countable chain condition, [244](#)
- countable closed topology, [45](#)
- countable ordinaltextbf, [423](#)
- countable set, [394](#)
- countable tightness, [147](#)
- countable-closed space, [147](#)
- countably compact, [189](#), [190](#)
- countably infinite, [394](#)
- Courant, Richard, [485](#)
- cover, [177](#)
- covering, [177](#)
 - open, [177](#)
- CR-manifold, [140](#)
- cube, [274](#), [274](#), [276](#), [277](#), [279](#), [300](#)
 - n , [230](#)
 - Hilbert, [230](#), [263](#), [264](#), [274](#), [283](#), [285](#), [299](#)
- curve
 - Sierpiński, [433](#)
 - space-filling, [253](#), [433](#)
- curves
 - Bézier, [364](#)
- cycle
 - m , [452](#)
- cylinder, [206](#)
- de Casteljou, Paul, [364](#)
- decreasing sequence, [150](#)
- degree
 - of trigonometric polynomial, [384](#), [385](#)
- Delian problem, [486](#)
- Della pittura, [488](#)
- dense, [78](#)
 - everywhere, [78](#)
 - nowhere, [165](#)
- density, [312](#)
- density character, [288](#), [386](#)
- denumerable, [394](#)
- derivative
 - partial, [368](#)
- derivative of a function of several variables, [368](#)
- derived set, [170](#)
- descriptive geometry, [490](#)
- Devaney, Robert L., [462](#)
- diagonal, [196](#), [550](#)
- diam, [470](#)
- diameter, [470](#)
- Dickstein, Samuel, [434](#)
- Dieudonné, Jean Alexandre Eugène, [309](#), [497](#)
- differentiable, [163](#)
 - manifold, [140](#)

- differentiable at a point, [367](#), [368](#)
- differentiable manifold, [367](#), [496](#)
- \dim_H , [473](#)
- dimension
 - Hausdorff, [473](#)
 - projective, [490](#)
 - zero, [122](#)
- Dini's Theorem, [370](#)
- Dini, Ulisse, [370](#)
- diophantine, [549](#)
- direct product
 - restricted, [529](#), [576](#)
 - weak, [529](#)
- directed, [313](#)
- directed set, [649](#)
- disconnected, [87](#), [118](#)
 - extremally, [637](#)
 - totally, [121](#), [524](#), [526](#)
- discrete
 - metric, [125](#)
 - space, [26](#)
 - topology, [26](#)
- distance, [124](#)
- distance between sets, [146](#)
- divisible
 - somewhat, [613](#)
- divisible group, [207](#), [503](#), [530](#)
- door space, [47](#), [94](#)
- double dual, [315](#)
- doubling function, [444](#)
- doubling the cube, [486](#)
- Dowker space, [307](#)
- dual
 - double, [315](#)
- dual group, [502](#), [556](#)
- dual space, [314](#)
- dyadic, [278](#)
- dynamical system, [441](#), [463](#)
 - chaotic, [463](#)
- dynamical systems
 - conjugate, [466](#)
- E^n , [344](#)
- ε -covering, [471](#)
- ε -number, [423](#)
- ε_1 , [423](#)
- ecology, [444](#)
- Egorov, Dimitri Feddrovich, [433](#)
- element
 - greatest, [85](#)
 - least, [85](#)
- embedded, [263](#), [277](#), [279](#), [283](#), [299](#)
- embedding, [265](#)
 - isometric, [155](#)
- Embedding Lemma, [238](#), [262](#), [274](#), [277](#)
- empty union, [30](#)
- equicontinuous, [554](#)
- equicontinuous at a point, [554](#)
- equipotent, [393](#)
- equivalence class, [342](#)
- equivalence relation, [109](#), [157](#), [342](#), [393](#)
- equivalent filterbases, [641](#)
- equivalent metric, [132](#)
- ergodic theory, [462](#)
- Erlangen program, [491](#)
- euclidean

- locally, [140](#), [509](#)
- euclidean geometry, [492](#)
- euclidean group, [495](#)
- euclidean metric, [125](#)
- euclidean metric on \mathbb{R}^2 , [125](#)
- Euclidean topology, [621](#)
- euclidean topology, [51](#)
- euclidean topology on \mathbb{R}^n , [60](#)
- evaluation map, [238](#), [262](#), [277](#), [327](#), [329](#)
- eventually, [650](#)
- eventually fixed, [440](#)
- eventually periodic, [440](#)
- everywhere dense, [78](#)
- exact sequence, [590](#)
- exterior, [164](#)
- exterior point, [164](#)
- extremally disconnected, [637](#)
- extremally disconnected space, [245](#)

- F_σ -set, [55](#), [170](#)
- f^{-1} , [42](#)
- F.I.P., [271](#)
- field
 - topological, [598](#)
- filter, [620](#)
 - generated by \mathcal{S} , [622](#)
 - Fréchet, [621](#)
 - free, [621](#)
 - neighbourhood, [621](#)
 - principal, generated by \mathcal{S} , [621](#)
- filter associated with the net, [652](#)
- filter base, [640](#)
- filter basis, [640](#)
 - filter determined by the sequence, [641](#)
 - filter generated by a filterbasis, [640](#)
 - filter in \mathcal{C} , [660](#)
 - filterbase, [640](#)
 - limit point, [642](#)
 - neighbourhood, [641](#)
 - filterbase associated with net, [652](#)
 - filterbases
 - equivalent, [641](#)
 - filterbasis, [640](#)
 - coarser, [641](#)
 - finer, [641](#)
 - final segment topology, [31](#)
 - finer, [622](#)
 - finer filterbasis, [641](#)
 - finer topology, [116](#), [198](#)
 - finite, [394](#)
 - locally, [306](#)
 - finite intersection property, [189](#), [271](#), [272](#), [273](#), [622](#), [625](#), [661](#)
 - finite space, [47](#)
 - finite subcovering, [177](#)
 - finite topological space, [47](#)
 - finite-closed topology, [39](#)
 - first axiom of countability, [137](#), [300](#), [619](#)
 - First Bifurcation Theorem, [452](#)
 - first category, [166](#)
 - first countable, [137](#), [300](#)
 - first uncountable ordinal, [423](#)
 - fixed point, [120](#), [161](#), [438](#)
 - attracting, [442](#)
 - eventually, [440](#)
 - neutral, [442](#)

- repelling, [442](#)
- fixed point property, [120](#)
- Fixed Point Theorem, [120](#)
 - Banach, [162](#)
- Fréchet filter, [621](#)
- Fréchet, Maurice, [430](#)
- fractal, [433](#)
 - geometry, [470](#)
- Frechet space, [147](#)
- Frechet topological vector space, [255](#)
- Frechet-Urysohn space, [147](#)
- free abelian group, [544](#)
- free abelian group basis, [544](#)
- free filter, [621](#)
- free ultrafilter in \mathcal{C} , [660](#)
- frequently, [650](#)
- Freyd Adjoint Functor Theorem, [326](#)
- function
 - analytic, [366](#)
 - bijjective, [41](#)
 - bump, [370](#)
 - continuous, [110](#)
 - doubling, [444](#)
 - injective, [41](#)
 - inverse, [41](#)
 - logistic, [444](#)
 - one-to-one, [41](#)
 - onto, [41](#)
 - smooth, [366](#)
 - surjective, [41](#)
 - tent, [468](#)
- functional
 - bounded linear, [316](#)
 - linear, [314](#)
- functions
 - almost-periodic, [599](#)
- Fundamenta Mathematica, [433](#)
- Fundamental Theorem of Algebra, [217](#)
- $GL(n, \mathbb{C})$, [513](#)
- G_δ -set, [55](#), [170](#)
- ΓX , [347](#)
- \mathfrak{G} -base, [313](#)
- Galileo Galilei, [395](#)
- Gauss, Carl Friedrich, [485](#)
- Gelfand-Naimark Representation Theorem, [388](#)
- general linear group, [494](#), [513](#)
- Generalized Heine-Borel Theorem, [184](#), [204](#)
- geometry
 - descriptive , [490](#)
 - euclidean, [492](#)
 - projective, [490](#)
- Georg Cantor, [401](#)
- graphical analysis, [444](#)
- greatest element, [85](#), [268](#), [269](#), [270](#)
- greatest lower bound, [85](#), [379](#)
- group, [493](#)
 - abelian, [493](#)
 - character, [556](#)
 - circle, [493](#)
 - commutator, [510](#)
 - compact Lie, [496](#)
 - divisible, [207](#), [503](#), [530](#)
 - dual, [502](#), [556](#)

- euclidean, [495](#)
- free abelian, [544](#)
- general linear, [494](#), [513](#)
- Heisenberg, [497](#)
- LCA, [523](#)
- Lie, [496](#)
- linear, [513](#)
- Lorentz, [492](#), [497](#)
- matrix, [494](#)
- Moskowitz-Morris, [605](#)
- NSS-, [509](#)
- orthogonal, [494](#), [513](#)
- pro-Lie, [507](#)
- product, [494](#)
- profinite, [506](#)
- projective, [495](#)
- quotient, [494](#), [523](#), [525](#)
- simple, [600](#)
- simply connected Lie, [506](#)
- special linear, [513](#)
- special orthogonal, [513](#)
- special unitary, [513](#)
- topological, [495](#), [512](#)
- topologically simple, [600](#)
- topology, [514](#)
- torsion, [576](#)
- torsion-free, [532](#)
- transformation, [492](#)
- unitary, [513](#)
- group of homeomorphisms, [101](#)
- group topology, [514](#)
- Hahn, Hans, [317](#)
- Hahn-Banach Theorem, [318](#), [321](#)
- Hausdorff
 - s -dimensional outer measure, [472](#)
 - collectionwise, [245](#)
 - dimension, [473](#)
 - Felix, [470](#)
- Hausdorff space, [94](#), [133](#), [196](#), [285](#), [301](#), [515](#)
- Hausdorff topological group, [527](#)
- Hausdorff, Felix, [431](#)
- Hausdorff-Besicovitch measure, [470](#)
- Heine-Borel Theorem, [182](#)
 - Converse, [183](#)
 - Generalized, [184](#)
- Heisenberg group, [497](#)
- hemicompact space, [304](#)
- hereditarily separable, [301](#)
- Hewitt-Marczewski-Pondiczery Theorem, [289](#)
- Higgs boson particle theory, [492](#)
- Hilbert cube, [230](#), [263](#), [264](#), [274](#), [283](#), [285](#), [299](#)
- Hilbert's fifth problem, [498](#)
- Hilbert, David, [428](#)
- Hofmann, Karl Heinrich, [485](#)
- homeomorphic, [96](#)
 - locally, [108](#)
- homeomorphism, [96](#)
 - local, [108](#)
- homogeneous, [515](#)
- homogeneous coordinates, [491](#)
- homomorphism, [494](#)
 - continuous, [519](#)

- ℐ, 55
- identification mapping, 343
- identification spaces, 343
- identity component, 508, 523
- identity matrix, 493
- identity of a group, 493
- if and only if, 56
- image
 - inverse, 42
- increasing sequence, 150
- indiscrete
 - space, 27
 - topology, 27
- induced topological space, 131
- induced topology, 91, 131
- induction
 - transfinite, 422
- inf, 85
- infimum, 85
- infinite, 394
 - countably, 394
- initial ordinal, 423
- initial segment, 420
- initial segment topology, 31
- injective, 41
- injective limit, 533
- Int, 83, 164
- integer, 55
- interior, 83, 164, 526
- interior point, 164
- Intermediate Value Theorem, 119
- intersection of topologies, 46
- interval, 104
- inverse
 - function, 41
 - image, 42
- inverse element in a group, 493
- inverse mapping system, 533
- invertible matrix, 493
- involution, 388
- irrational number, 55
- isolated point, 170, 224
- isometric, 137, 155
 - embedding, 155
- isometry, 137, 155
- isomorphic
 - order, 416
 - topologically, 496, 519
- isomorphic as a C^* -algebra, 388
- isomorphism, 494
 - order, 416
 - topological, 519
 - topological group, 519
- iterate, 437
- jointly continuous, 552
- \mathbb{K} , 351
- k -space, 303
- k_ω -space, 299
- kernel, 494
- Killing, William, 506
- Klein bottle, 351
- Klein, Felix, 485
- Knuth, Donald, 6, 10
- Kronecker, Leopold, 604
- ℓ_1 , 159

- l_2 , 159
- l_∞ , 159
- l_1 , 136
- l_2 , 136
- l_∞ , 136
- La Trobe University, 505
- lattice, 379
- LCA-group, 523
 - compactly generated, 582
- least element, 85
- least upper bound, 379
- Least Upper Bound Axiom, 85
- Lebesgue measure, 462, 470, 527
- left uniformity, 551
- Lemma
 - Embedding, 238, 274, 277
 - Urysohn's, 278
 - Zorn's, 179, 269, 269, 271, 272, 318
- Levine property, 172
- Lie group, 496
 - compact, 496
 - simply connected, 506
- limit, 628
 - injective, 533
 - projective, 507, 533
- limit of a net, 650
- limit ordinal, 421
- limit point, 73
- limit point of filterbase, 642
- Lindelöf space, 298, 299
- Lindelöf's Theorem, 243
- Lindelöf degree, 312
- Lindemann, Ferdinand, 486
- Lindenbaum, Adolph, 434
- line
 - projective, 490
 - Sorgenfrey, 84, 179, 197
- linear functional, 314
- linear group, 513
- linear operator, 316
- linear order, 268, 415
- linear transformation, 525
- linearly independent, 271
- linearly ordered set, 268–272, 415
- Lipschitz, Rudolf Otto Sigismund , 485
- local
 - homeomorphism, 108
- locally
 - compact, 189, 207
 - connected, 216
 - euclidean, 140
 - homeomorphic, 108
- locally k_ω -group, 588
- locally compact subgroup, 521, 526
- locally connected, 252, 301
- locally convex space, 210, 211, 265
- locally euclidean, 497, 509
- locally finite, 306
- locally isomorphic, 547
- logistic function, 444
- Lorentz group, 492, 497
- lower bound, 85, 379
 - greatest, 379
- lower complete, 312
- lower semicontinuous, 172
- Luzin, Nikolai Nikolaevich, 433

- M**, 349
- m.a.p., 600
- Möbius band, 349
- Möbius strip, 349
- Mandelbrot
 - Benoit, 470
- manifold
 - Cauchy-Riemann, 140
 - connected, 140
 - CR-, 140
 - differentiable, 140, 367, 496
 - Riemannian, 140
 - smooth, 140
 - topological, 140
 - topological with boundary, 140
- MAP, 599
- map
 - bijjective, 41
 - conjugate, 466
 - evaluation, 238
 - injective, 41
 - inverse, 41
 - one-to-one, 41
 - onto, 41
 - quadratic, 451
 - surjective, 41
- Maple, 487
- mapping
 - closed, 186, 198, 340
 - continuous, 112
 - contraction, 161
 - evaluation, 262, 277, 327, 329
 - identification, 343
 - lower semicontinuous, 172
 - open, 169, 186, 198, 340, 523
 - quotient, 338
 - upper semicontinuous, 172
- Marczewski, Edward, 285
- market
 - stock, 441
- mathematical induction, 417
- mathematical proof, 25
- matrix
 - identity, 493
 - invertible, 493
 - nonsingular, 493
 - orthogonal, 513
 - unitary, 513
- matrix group, 494
- maximal, 269, 269–273
- maximally almost periodic, 599
- May
 - Robert L., 461
- Mazurkiewicz, Stefan, 433
- meager, 166
- Mean Value Theorem, 163
- measure
 - Hausdorff-Besicovitch, 470
 - Lebesgue, 470, 527
- metacompact, 310
- metric, 124
 - bounded, 134
 - discrete, 125
 - equivalent, 132
 - euclidean, 125, 125
 - Post Office, 245

- space, [124](#)
- metric space, [285](#)
 - bounded, [134](#)
 - complete, [149](#)
 - totally bounded, [139](#)
- metrizable, [134](#)
 - $-\sigma$, [299](#)
 - completely, [153](#)
- metrizable space, [263](#), [264](#), [299](#)
- minimally almost periodic, [600](#)
- monothetic, [580](#)
- monotonic sequence, [150](#)
- Morris, Sidney A., [505](#)
- Morse
 - Harold Calvin Marston, [462](#)
- Moskowitz-Morris group, [605](#)
- \mathbb{N} , [93](#)
- \mathbb{N} , [26](#)
- n -cube, [230](#)
- n -sphere, [205](#)
- natural numbers
 - Sarkovskii's ordering, [456](#)
- neighbourhood
 - symmetric, [515](#)
- neighbourhood, [81](#)
- neighbourhood filter, [621](#)
- neighbourhood filterbase, [641](#)
- net, [649](#)
 - convergent, [650](#)
 - universal, [653](#)
- net associated with filter, [652](#)
- net associated with filterbase, [652](#)
- network, [246](#)
- network weight, [246](#)
- Neumann, Carl, [485](#)
- neutral fixed point, [442](#)
- no small subgroups, [509](#)
- non-decreasing, [654](#)
- non-discrete Hausdorff group topology, [531](#)
- nonsingular matrix, [493](#)
- norm, [128](#), [211](#)
 - operator, [316](#)
 - sup, [370](#)
 - uniform, [370](#)
- normal space, [137](#), [187](#), [277](#), [278](#), [279](#), [283–285](#), [298–301](#)
- normal subgroup, [493](#), [526](#)
- normed algebra, [377](#)
- normed vector space, [128](#)
 - quotient, [320](#)
- nowhere dense, [165](#)
- NSS-group, [509](#)
- number
 - algebraic, [398](#)
 - cardinal, [406](#)
 - irrational, [55](#)
 - ordinal, [418](#)
 - prime, [55](#)
 - transcendental, [398](#), [486](#)
- $O(n)$, [513](#)
- ω -narrow, [518](#), [528](#)
- ω , [418](#)
- ω_1^{CK} , [423](#)

- object, [110](#)
- one-to-one, [41](#)
- one-to-one correspondence, [393](#)
- onto, [41](#)
- open
 - ball, [129](#)
 - covering, [177](#)
 - mapping, [169](#), [186](#), [198](#), [340](#)
 - sequentially, [146](#)
 - set, [32](#)
- open covering, [177](#)
- open mapping, [523](#)
- Open Mapping Theorem, [168](#)
 - for Locally Compact Groups, [535](#)
- open subgroup, [520](#)
- operator
 - bounded linear, [316](#)
 - linear, [316](#)
- operator norm, [316](#)
- or
 - as used in matheamtics, [.6](#)
- orbit, [437](#)
- order
 - linear, [268](#), [415](#)
 - partial, [265](#), [378](#)
 - strict linear, [268](#), [415](#)
 - strict total, [268](#), [415](#)
- order diagram, [267–270](#)
- order isomorphic, [416](#)
- order isomorphism, [416](#)
- order type, [416](#)
- ordering
 - Sarkovskii's, [456](#)
- ordinal
 - Church-Kleene, [423](#)
 - countable, [423](#)
 - initial, [423](#)
 - limit, [421](#)
 - predecessor, [421](#)
 - successor, [421](#)
- ordinal number, [418](#)
- orthogonal
 - matrix, [513](#)
- orthogonal group, [494](#), [513](#)
 - special, [513](#)
- P -based topological space, [313](#)
- \mathbb{P} , [55](#), [93](#)
- $\mathcal{P}(S)$, [401](#)
- paracompact, [309](#)
- paradox
 - Banach-Tarski, [427](#)
- parallelotope, [540](#)
- partial derivative, [368](#)
- partial order, [265](#), [266](#), [271](#), [272](#), [378](#)
- partially ordered set, [265](#), [266](#), [268–270](#), [378](#), [624](#)
- partition of unity, [308](#)
- path, [118](#)
- path-connected, [118](#), [209](#)
- pathwise connected, [118](#)
- peak point, [150](#)
- perfect set, [170](#)
- perfect space, [170](#), [224](#)
- period doubling bifurcation, [453](#)
- Period Three Theorem, [455](#)

- periodic, [440](#)
 - eventually, [440](#)
- periodic point
 - attracting, [452](#)
 - repelling, [452](#)
- perspective, [488](#)
- Peter, Fritz, [501](#)
- phase portrait, [441](#)
- Plücker, Julius, [485](#)
- plane
 - Sorgenfrey, [301](#)
 - textbf, [490](#)
- Poincarè
 - Jules Henri, [461](#)
- point, [73](#)
 - accumulation, [73](#)
 - attracting fixed, [442](#)
 - attracting periodic, [452](#)
 - boundary, [164](#)
 - cluster, [73](#)
 - exterior, [164](#)
 - fixed, [120](#), [161](#)
 - interior, [164](#)
 - isolated, [170](#), [224](#)
 - limit, [73](#)
 - neighbourhood of, [81](#)
 - neutral fixed, [442](#)
 - peak, [150](#)
 - repelling fixed, [442](#)
 - repelling periodic, [452](#)
- pointwise convergent, [365](#)
- Polish space, [154](#)
- polynomial
 - Bernstein, [309](#), [363](#)
 - complextrigonometric, [385](#)
 - real trigonometric, [384](#)
- polynomials
 - Bernstein (basis) polynomials, [308](#)
- Pontryagin van-Kampen Duality Theorem, [595](#)
- Pontryagin, Lev Semyonovich, [502](#)
- Pontryagin-van Kampen Duality Theorem for Compact Groups, [575](#)
- Pontryagin-van Kampen Duality Theorem for Discrete Groups, [576](#)
- population growth, [441](#), [444](#)
- portrait
 - phase, [441](#)
- poset, [265](#), [312](#)
 - Tukey dominated, [313](#)
- posets
 - Tukey equivalent, [313](#)
- Post Office metric, [245](#)
- power set, [401](#)
- pre-annihilator, [320](#)
- predecessor ordinal, [421](#)
- prime number, [55](#)
- prime period, [440](#)
- principal filter generated by ξ , [621](#)
- Principal Structure Theorem for LCA-Groups, [596](#)
- Principle of the Excluded Middle, [429](#)
- pro-Lie group, [507](#), [548](#)
- product, [194](#), [224](#), [260](#), [300](#)
 - topology, [194](#)
 - cartesian, [260](#)

- restricted direct, [529](#)
- semidirect, [495](#), [536](#)
- space, [194](#), [260](#), [261](#)
- topology, [200](#), [260](#)
- weak direct, [529](#)
- product group, [494](#)
- product of cardinal numbers, [411](#)
- product of two ordinals, [419](#)
- product space, [224](#), [274](#), [298](#)
- product topology, [63](#), [224](#), [260](#)
- profinite group, [506](#)
- projective dimension, [490](#)
- projective geometry, [490](#)
- projective group, [495](#)
- projective limit, [507](#), [533](#)
- projective line, [490](#)
- projective mapping system, [533](#)
- projective plane, [490](#)
 - real, [350](#)
- projective space, [490](#)
 - real, [350](#)
- proof
 - by contradiction, [53](#)
 - if and only if, [56](#)
 - mathematical, [25](#)
- proper subset, [37](#)
- property
 - separation, [49](#)
 - fixed point, [120](#)
 - topological, [109](#)
- protorus, [503](#)
- \mathbb{Q} , [54](#), [93](#), [265](#)
- quadratic map, [451](#)
- quadrature of the circle, [486](#)
- quasicompact, [192](#)
- quotient group, [494](#), [523](#), [525](#)
- quotient mapping, [338](#)
- quotient maps not always closed, [524](#)
- quotient normed vector space, [320](#)
- quotient space, [338](#)
- quotient topology, [523](#)
- \mathbb{R} , [31](#), [51](#), [265](#)
- \mathbb{R}^2 , [60](#)
- \mathbb{R}^n , [60](#)
- \mathbb{R}
 - \mathbb{P}^2 , [350](#)
 - \mathbb{R}
 - \mathbb{P}^n , [350](#)
- rationally dependent, [538](#)
- real projective plane, [350](#)
- real projective space, [350](#)
- real trigonometric polynomial, [384](#)
- reduced cone, [347](#)
- reduced suspension, [347](#)
- refinement, [306](#), [641](#)
- reflection, [492](#)
- reflexive, [97](#), [578](#)
- reflexive Banach space, [315](#), [321](#), [322](#)
- reflexive binary relation, [97](#), [265](#), [378](#)
- reflexivity of dual Banach space, [321](#)
- regular, [197](#)
 - completely, [274](#)
 - space, [95](#)
- regular space, [280](#), [283](#), [284](#), [298](#), [300](#)

- relation
 - equivalence, [109](#), [157](#), [393](#)
- relative topology, [91](#)
- relatively compact, [188](#)
- relativity
 - special, [492](#)
- repelling fixed point, [442](#)
- repelling periodic point, [452](#)
- restricted direct product, [529](#), [576](#)
- retract, [293](#)
- Riemannian
 - manifold, [140](#)
- right uniformity, [551](#)
- rigid motion, [492](#)
- Risch, Henery, [487](#)
- rotation, [492](#)
- Rotkiewicz, Andrzej, [434](#)
- Royal Society, [461](#)
- Russell, Bertram, [428](#)
- Ruziewicz, Stanislaw, [433](#)

- $SL(n, \mathbb{C})$, [513](#)
- ΣX , [347](#)
- σ -compact space, [303](#)
- \mathbf{S}^n , [350](#)
- \mathbf{S}^{n-1} , [344](#)
- s -dimensional outer measure
 - Hausdorff , [472](#)
- \mathbf{S}^1 , [205](#)
- \mathbf{S}^1 , [140](#)
- \mathbf{S}^n , [205](#)
- Saks, Stanislaw, [434](#)
- Sarkovskii's ordering, [456](#)
 - Sarkovskii's Theorem, [456](#)
 - converse, [457](#)
- saturated set, [47](#)
- scattered space, [245](#)
- Schauder, Juliusz Pawel, [434](#)
- second axiom of countability, [62](#), [197](#), [241](#)
- second category, [166](#)
- second countable, [62](#), [241](#), [283](#), [285](#), [299](#)
- seed, [437](#)
- semi-open, [108](#)
- semicontinuous
 - lower, [172](#)
 - upper, [172](#)
- semidirect product, [536](#)
- semidirect product, [495](#)
- seminorm, [211](#)
- semisimple, [510](#)
- sensitively on initial conditions, [464](#)
- sensitivity, [464](#)
- separable, [83](#), [154](#), [197](#), [236](#)
 - hereditarily, [301](#)
- separable Banach space, [159](#), [208](#), [319](#)
- Separable Quotient Problem, [323](#)
- separable space, [263](#), [264](#), [285](#), [299](#), [301](#)
- separate points, [374](#)
- separates points, [238](#), [262](#)
- separates points and closed sets, [238](#), [262](#)
- separation property, [49](#)
- sequence
 - Cauchy, [148](#)
 - convergent, [141](#), [190](#)

- decreasing, [150](#)
- increasing, [150](#)
- monotonic, [150](#)
- sequential space, [146](#), [303](#), [341](#), [342](#), [347](#)
- sequentially closed, [146](#)
- sequentially compact, [190](#)
- sequentially continuous, [147](#)
- sequentially open, [146](#)
- set
 - F_σ , [55](#), [170](#)
 - G_δ , [55](#), [170](#)
 - of continuous real-valued functions, [68](#)
 - absolutely convex, [209](#)
 - absorbent, [209](#)
 - analytic, [154](#), [433](#)
 - bounded, [160](#)
 - Cantor, [222](#)
 - clopen, [36](#)
 - closed, [34](#)
 - convex, [167](#), [209](#)
 - countable, [394](#)
 - denumerable, [394](#)
 - derived, [170](#)
 - directed, [649](#)
 - finite, [394](#)
 - first category, [166](#)
 - infinite, [394](#)
 - linearly ordered, [268–272](#), [415](#)
 - meager, [166](#)
 - of integers, [54](#), [93](#)
 - of irrational numbers, [55](#), [93](#)
 - of natural numbers, [26](#), [93](#)
 - of positive integers, [26](#), [93](#)
 - of rational numbers, [54](#), [93](#)
 - of real numbers, [31](#)
 - open, [32](#)
 - partially ordered, [270](#)
 - partially ordered, [265](#), [266](#), [268–270](#), [378](#), [624](#)
 - perfect, [170](#)
 - power, [401](#)
 - saturated, [47](#)
 - second category, [166](#)
 - semi-open, [108](#)
 - totally ordered, [268](#), [415](#)
 - uncountable, [394](#)
 - well-ordered, [269](#), [415](#)
- Shrinking Lemma for Normal Spaces, [307](#)
- shrinking of a cover, [307](#)
- Sierpiński
 - space, [45](#)
- Sierpiński
 - curve, [433](#)
 - carpet, [433](#)
 - triangle, [433](#)
- Sierpiński, Waclaw, [432](#)
- simple group, [600](#)
- Smith
 - P.A., [462](#)
- smooth
 - manifold, [140](#)
- smooth function, [366](#)
- solenoidal, [598](#)
- somewhat divisible, [613](#)

- Sorgenfrey line, [84](#), [179](#), [298](#), [301](#)
- Sorgenfrey plane, [301](#)
- Souslin space, [154](#)
- space
- T_3 , [280](#), [281](#)
 - T_4 , [281](#)
 - σ -compact, [303](#)
 - σ -metrizable, [299](#)
 - k_* , [303](#)
 - k_ω , [588](#)
 - k_ω , [299](#)
 - Tychonoff, [327](#)
 - Asplund, [324](#)
 - Baire, [165](#)
 - Banach, [158](#), [265](#), [525](#)
 - bikompakt, [192](#)
 - Cantor, [222](#)
 - collectionwise Hausdorff, [245](#)
 - compact, [177](#), [265](#), [272–274](#), [277](#), [279](#), [284](#), [299](#), [326](#), [631](#), [646](#)
 - compactly-generated, [303](#)
 - complete metric, [149](#)
 - completely metrizable, [153](#)
 - completely regular, [274–276](#), [300](#)
 - connected, [86](#), [298](#), [301](#)
 - cosmic, [247](#)
 - countable-closed, [147](#)
 - countably compact, [190](#)
 - disconnected, [87](#)
 - discrete, [26](#)
 - door, [47](#), [94](#)
 - Dowker, [307](#)
 - dual, [314](#)
 - extremally disconnected, [245](#)
 - finite, [47](#)
 - first countable, [300](#)
 - Frechet, [147](#)
 - Frechet-Urysohn, [147](#)
 - Hausdorff, [94](#), [133](#), [196](#), [285](#), [301](#), [515](#)
 - hemicompact, [304](#)
 - hereditarily separable, [301](#)
 - homogeneous, [515](#)
 - identification, [343](#)
 - indiscrete, [27](#)
 - induced by a metric, [131](#)
 - Lindelöf, [298](#), [299](#)
 - locally compact, [189](#), [207](#)
 - locally connected, [216](#), [252](#), [301](#)
 - locally convex, [210](#), [211](#), [265](#)
 - metric, [124](#), [285](#)
 - metrizable, [134](#), [263](#), [264](#), [299](#)
 - normal, [137](#), [187](#), [277–279](#), [283–285](#), [298–301](#)
 - normed vector, [128](#)
 - perfect, [170](#), [224](#)
 - Polish, [154](#)
 - product, [194](#), [224](#), [260](#), [261](#), [274](#), [298](#)
 - projective, [490](#)
 - quotient, [338](#)
 - real projective, [350](#)
 - reflexive Banach, [315](#)
 - regular, [95](#), [197](#), [280](#), [283](#), [284](#), [298](#), [300](#)
 - scattered, [245](#)

- second countable, [241](#), [283](#), [285](#), [299](#)
- separable, [83](#), [154](#), [197](#), [236](#), [263](#), [264](#), [285](#), [299](#), [301](#)
- separable Banach, [159](#), [208](#)
- sequential, [146](#), [303](#), [341](#), [342](#), [347](#)
- sequentially compact, [190](#)
- Sierpiński, [45](#)
- Souslin, [154](#)
- strongly σ -metrizable, [299](#)
- supercompact, [188](#)
- Suslin, [154](#)
- T_0 , [45](#)
- T_1 , [44](#), [197](#), [239](#), [515](#)
- T_2 , [94](#), [133](#)
- T_3 , [95](#), [299](#)
- T_4 , [137](#), [277](#), [279](#)
- $T_{3\frac{1}{2}}$, [275–277](#), [279](#), [299](#), [327](#), [329](#)
- $T_{3\frac{1}{2}}$, [298](#), [300](#), [326](#)
- $T_{3\frac{1}{2}}$, [274](#)
- topological, [25](#)
- totally disconnected, [121](#), [197](#)
- Tychonoff, [274](#), [275–277](#), [279](#), [298](#), [300](#), [326](#), [329](#)
- uniform, [551](#)
- WCG, [322](#)
- space of bounded linear operators, [316](#)
- space-filling curve, [253](#), [433](#)
- space; compact, [326](#)
- span, [317](#)
- special
 - unitary group, [513](#)
 - orthogonal group, [513](#)
- special linear group, [513](#)
- special relativity, [492](#)
- spread, [312](#)
- squaring the circle, [486](#)
- Steinhaus, Hugo Dyonizy, [427](#)
- stock market, [441](#)
- Stone, Marshall Harvey, [354](#)
- Stone-Čech Compactification, [326](#), [329–332](#), [335](#)
- Stone-Weierstrass Theorem, [382](#), [383](#)
- strict linear order, [268](#), [415](#)
- strict total order, [268](#), [415](#)
- strong topology, [315](#)
- strongly σ -metrizable, [299](#)
- Studia Mathematica, [427](#)
- subalgebra, [377](#)
- subbasis, [69](#)
- subcovering
 - finite, [177](#)
- subgroup, [493](#)
 - commutator, [526](#), [533](#)
 - locally compact, [521](#), [526](#)
 - normal, [493](#), [526](#)
 - open, [520](#)
- subgroup topology, [517](#)
- sublattice, [379](#)
- subnet, [654](#)
- subordinate, [308](#)
- subsequence, [150](#)
- subset
 - dense, [78](#)
 - everywhere dense, [78](#)
 - proper, [37](#)
- subspace, [91](#)

- subspace topology, [91](#)
- successor ordinal, [421](#)
- sum of cardinal numbers, [409](#)
- sum of ordinal numbers, [419](#)
- sup, [85](#)
- Sup norm, [370](#)
- supercompact, [188](#)
- support of a function, [370](#)
- suppose
 - proof by contradiction, [53](#)
- supremum, [85](#)
- surface, [206](#)
- surjective, [41](#)
- Suslin space, [154](#)
- suspension, [345](#)
 - reduced, [347](#)
- symmetric binary relation, [97](#)
- symmetric neighbourhood, [515](#)
- symmetry, [492](#)
- system
 - dynamical, [463](#)
- systems
 - conjugate dynamical, [466](#)
- $\text{T}_{\text{E}}\text{X}$, [6](#)
- T_0 -space, [45](#)
- T_1 -space, [44](#), [197](#)
- T_2 -space, [94](#), [133](#)
- T_3 -space, [95](#)
- T_4 -space, [137](#)
- T_1 -space, [239](#), [515](#)
- T_3 -space, [280](#), [281](#), [299](#)
- T_4 -space, [277](#), [279](#), [281](#)
- $T_{3\frac{1}{2}}$ -space, [274](#), [275–277](#), [279](#), [299](#), [327](#), [329](#)
- $T_{3\frac{1}{2}}$, [298](#)
- $T_{3\frac{1}{2}}$ -space, [300](#), [326](#)
- Tarski, Alfred, [427](#)
- tent function, [468](#)
- Theorem
 - Baire Category, [165](#)
 - Real Stone Weierstrass, [382](#)
 - Alexander Subbasis, [179](#)
 - Ascoli, [554](#)
 - Baire Category, [164](#)
 - Baire Category for Locally Compact Spaces, [534](#)
 - Banach Fixed Point, [162](#)
 - Banach-Alaoglu, [316](#), [322](#)
 - Banach-Mazur, [386](#)
 - Bolzano-Weierstrass, [151](#)
 - Brouwer Fixed Point, [120](#)
 - Complex Stone-Weierstrass, [383](#)
 - Contraction Mapping, [162](#)
 - Converse of Heine-Borel, [183](#)
 - Converse of Sarkovskii's, [457](#)
 - Dini's
 - textbf, [370](#)
 - First Bifurcation, [452](#)
 - Freyd Adjoint Functor, [326](#)
 - Fundamental Theorem of Algebra, [217](#)
 - Gelfand-Naimark Representation, [388](#)
 - Generalized Heine-Borel, [184](#), [204](#)
 - Hahn-Banach, [318](#), [321](#)
 - Heine-Borel, [182](#)
 - Hewitt-Marczewski-Pondiczery, [289](#)

- Lindelöf's, [243](#)
- Mean Value, [163](#)
- Open Mapping, [168](#)
- Open Mapping for Locally Compact Groups, [535](#)
- Pontryagin van-Kampen Duality, [595](#)
- Pontryagin-van Kampen Duality for Compact Groups, [575](#)
- Pontryagin-van Kampen Duality for Discrete Groups, [576](#)
- Principal Structure for LCA-Groups, [596](#)
- Sarkovskii's, [456](#)
- The Period Three, [455](#)
- Tietze Extension, [294](#)
- Toruńczyk, [256](#)
- Tychonoff, [203](#), [259](#), [265](#), [273](#), [631](#)
- Tychonoff's, [271](#), [619](#)
- Urysohn and its Converse, [242](#)
- Urysohn Metrization, [284](#)
- Urysohn's, [240](#), [285](#)
- Weierstrass Approximation, [360](#)
- Weierstrass Intermediate Value, [119](#)
- Well-Ordering, [269](#), [269](#), [633](#)
- Well-ordering, [416](#)
- three space property, [324](#), [589](#), [601](#)
- Tietze Extension Theorem, [294](#)
- tightness
 - countable, [147](#)
- topological
 - manifold, [140](#)
 - manifold with boundary, [140](#)
- topological field, [598](#)
- topological group, [300](#), [495](#), [512](#)
 - ω -narrow, [518](#)
 - compactly generated, [522](#)
 - connected, [522](#)
 - Hausdorff, [527](#)
 - isomorphism, [519](#)
 - topology, [514](#)
- topological group isomorphism, [519](#)
- topological isomorphism, [519](#)
- topological property, [109](#)
- topological space, [25](#)
 - P -based, [313](#)
 - finite, [47](#)
- topological vector space, [208](#)
 - Frechet, [255](#)
- topologically isomorphic, [496](#), [519](#)
- topologically simple group, [600](#)
- topologically transitive, [466](#)
- topology, [25](#)
 - intersection, [46](#)
 - box, [225](#)
 - coarser, [116](#), [198](#)
 - coarsest, [261](#)
 - cofinite, [39](#)
 - compact-open, [552](#)
 - countable closed, [45](#)
 - discrete, [26](#)
 - Euclidean, [621](#)
 - euclidean, [51](#)
 - euclidean on \mathbb{R}^n , [60](#)
 - final segment, [31](#)
 - finer, [116](#), [198](#)
 - finite-closed, [39](#)

- indiscrete, [27](#)
- induced, [91](#)
- induced by a metric, [131](#)
- initial segment, [31](#)
- product, [63](#), [194](#), [200](#), [224](#), [260](#), [260](#)
- quotient, [523](#)
- relative, [91](#)
- strong, [315](#)
- subgroup, [517](#)
- subspace, [91](#)
- topological group, [514](#)
- Tychonoff, [260](#)
- usual, [93](#)
- weak, [315](#)
- weak*, [315](#)
- topology of pointwise convergence, [552](#)
- torsion group, [576](#)
- torsion-free, [532](#)
- Toruńczyk Theorem, [256](#)
- torus, [205](#)
- totally bounded
 - metric space, [139](#)
- totally disconnected, [121](#), [197](#), [524](#), [526](#)
- totally disconnected normal subgroup, [526](#)
- totally ordered set, [268](#), [415](#)
- transcendental number, [398](#), [486](#)
- transfinite induction, [422](#)
- transformation
 - linear, [525](#)
- transformation group, [492](#)
- transitive, [463](#)
 - topologically, [466](#)
- transitive binary relation, [97](#), [265](#), [378](#)
- translation, [492](#)
- transpose of a matrix, [494](#)
- triangle
 - Sierpiński, [433](#)
- trisecting an angle, [486](#)
- Tukey dominated poset, [313](#)
- Tukey equivalent posets, [313](#)
- two-sided uniformity, [551](#)
- Tychonoff
 - topology, [260](#)
- Tychonoff space, [274](#), [275–277](#), [279](#), [298](#), [300](#), [326](#), [327](#), [329](#)
- Tychonoff's Theorem, [203](#), [259](#), [265](#), [271](#), [273](#), [619](#), [631](#)
- $U(n)$, [513](#)
- Ulam, Stanislaw, [427](#)
- ultrafilter, [623](#), [624](#), [625](#)
 - free in \mathcal{C} , [660](#)
- ultrafilter base, [648](#)
- ultrafilter in \mathcal{C} , [660](#)
- Ultrafilter Lemma, [624](#)
- ultrafilterbase, [648](#)
- ultrafilterbasis, [648](#)
- ultranet, [653](#)
- uncountable set, [394](#)
- uniform norm, [370](#)
- uniform space, [551](#)
- uniformity, [551](#)
 - left, [551](#)
 - right, [551](#)
 - two-sided, [551](#)
- uniformly convergent, [365](#), [371](#)

- union
 - empty, 30
- unit ball, 187
- unital algebra, 376
- unitary
 - matrix, 513
- unitary group, 513
 - special, 513
- universal net, 653
- upper bound, 85, 268, 269, 271, 272, 379
 - least, 379
- upper semicontinuous, 172
- Urysohn's Lemma, 278, 301
- Urysohn's Metrization Theorem, 284
- Urysohn's Theorem, 240, 285
- Urysohn's Theorem and its Converse, 242
- usual topology, 93
- usual uniformity on \mathbb{R} , 551
- V -disjoint, 518
- Výborný, Rudolf, 354
- van der Waerden, Bartel Leendert, 428
- van Kampen, Egbert Rudolf, 502
- vanish at infinity, 387
- variety of topological groups, 528
- vector space
 - normed, 128
- von Neuman, John, 501
- ωX , 663
- Wallman compactification, 665
- Wantzel, Pierre Laurent, 487
- WCG space, 322
- weak direct product, 529
- weak topology, 315
- weak*-compact, 316
- weak*-topology, 315
- weakly compactly generated, 322
- weather, 441
- Weierstrass Approximation Theorem, 360
- Weierstrass Intermediate Value Theorem, 119
- Weierstrass, Karl, 354
- weight, 246
 - network, 246
- well-ordered set, 269, 415
- well-ordering, 415
- Well-Ordering Theorem, 269, 269, 633
- Well-ordering Theorem, 416
- Weyl, Hermann, 501
- Wikipedia, 10
- \mathbb{Z} , 54, 93
- $\mathbb{Z} >$, 265
- 0-dimensional, 122
- Zaremba, Stanislaw, 434
- Zentralblatt für Mathematik, 434
- Zermelo-Fraenkel axioms, 632
- zero-dimensional, 122
- ZF, 416, 632
- ZFC, 416
- Zorn's Lemma, 179, 265, 269, 269, 271, 272, 318