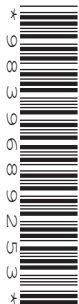

CANDIDATE  
NAMECENTRE  
NUMBER

--	--	--	--	--

CANDIDATE  
NUMBER

--	--	--	--

**CAMBRIDGE INTERNATIONAL MATHEMATICS****0607/42**

Paper 4 (Extended)

**October/November 2019****2 hours 15 minutes**

Candidates answer on the Question Paper.

Additional Materials:      Geometrical Instruments  
   Graphics Calculator**READ THESE INSTRUCTIONS FIRST**

Write your centre number, candidate number and name on all the work you hand in.

Write in dark blue or black pen.

Do not use staples, paper clips, glue or correction fluid.

You may use an HB pencil for any diagrams or graphs.

DO **NOT** WRITE IN ANY BARCODES.Answer **all** the questions.

Unless instructed otherwise, give your answers exactly or correct to three significant figures as appropriate.

Answers in degrees should be given to one decimal place.

For  $\pi$ , use your calculator value.

You must show all the relevant working to gain full marks and you will be given marks for correct methods, including sketches, even if your answer is incorrect.

The number of marks is given in brackets [ ] at the end of each question or part question.

The total number of marks for this paper is 120.

This document consists of **20** printed pages.

## Formula List

For the equation  $ax^2 + bx + c = 0$   $x = \frac{-b \pm \sqrt{b^2 - 4ac}}{2a}$

Curved surface area,  $A$ , of cylinder of radius  $r$ , height  $h$ .  $A = 2\pi rh$

Curved surface area,  $A$ , of cone of radius  $r$ , sloping edge  $l$ .  $A = \pi rl$

Curved surface area,  $A$ , of sphere of radius  $r$ .  $A = 4\pi r^2$

Volume,  $V$ , of pyramid, base area  $A$ , height  $h$ .  $V = \frac{1}{3}Ah$

Volume,  $V$ , of cylinder of radius  $r$ , height  $h$ .  $V = \pi r^2 h$

Volume,  $V$ , of cone of radius  $r$ , height  $h$ .  $V = \frac{1}{3}\pi r^2 h$

Volume,  $V$ , of sphere of radius  $r$ .  $V = \frac{4}{3}\pi r^3$

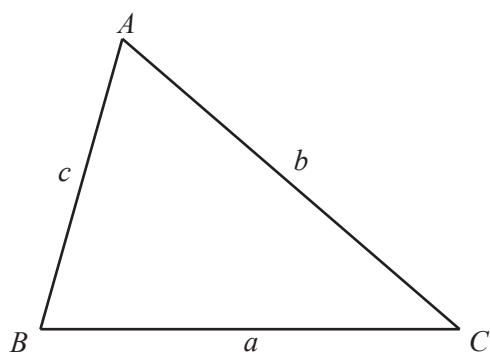

$$\frac{a}{\sin A} = \frac{b}{\sin B} = \frac{c}{\sin C}$$

$$a^2 = b^2 + c^2 - 2bc \cos A$$

$$\text{Area} = \frac{1}{2}bc \sin A$$

Answer **all** the questions.

1

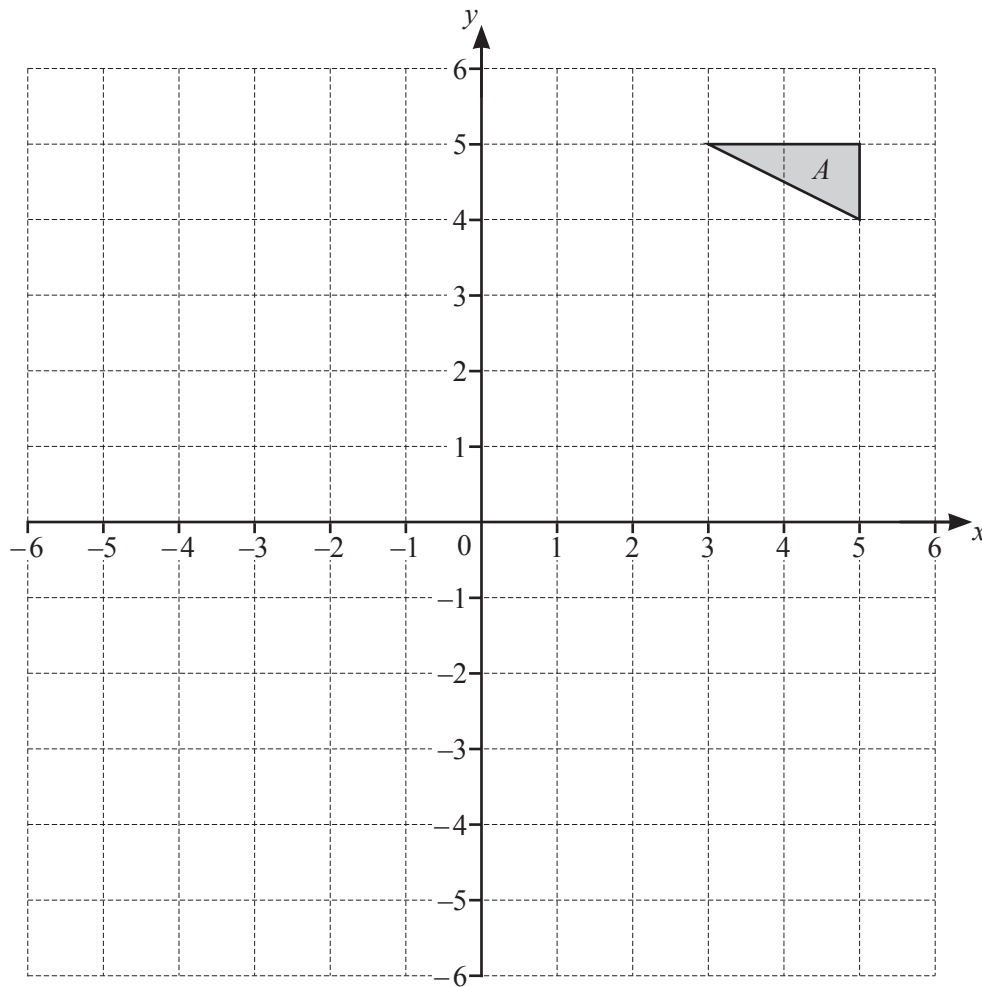

- (a) Reflect triangle *A* in the *x*-axis. Label the image *B*. [1]
- (b) Translate triangle *A* by the vector  $\begin{pmatrix} 0 \\ -3 \end{pmatrix}$ . Label the image *C*. [1]
- (c) Describe fully the **single** transformation that maps triangle *B* onto triangle *C*.

..... [2]

- (d) Rotate triangle *A* through  $90^\circ$  anti-clockwise, about the origin. Label the image *D*. [2]
- (e) Describe fully the **single** transformation that maps triangle *B* onto triangle *D*.

..... [2]

2       $f(x) = \frac{1}{x-2}, x \neq 2$        $g(x) = x+2$        $h(x) = x^2$

(a) Find  $f(6)$ .

..... [1]

(b) Solve  $f(x) = -2$ .

$x =$  ..... [2]

(c) Find  $h(g(x))$ .

..... [1]

(d) Solve  $h(g(x)) = h(x) + 2$ .

$x =$  ..... [4]

(e) Find  $f^{-1}(x)$ .

$f^{-1}(x) =$  ..... [3]

5

(f)

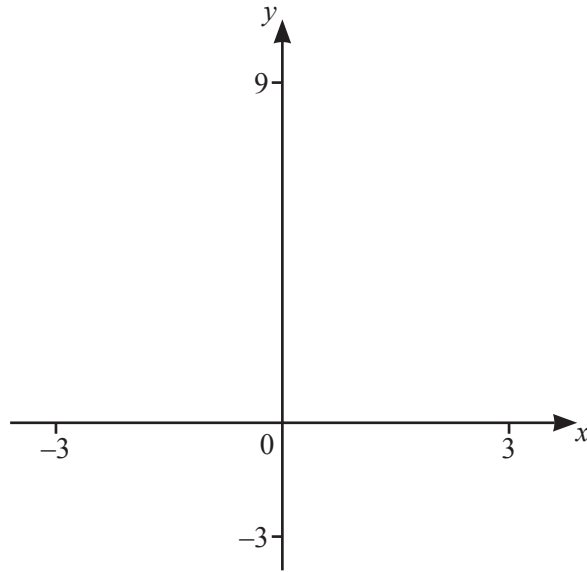

(i) On the diagram, sketch the graph of  $y = f(x)$  and the graph of  $y = h(x)$  for values of  $x$  between  $-3$  and  $3$ . [3]

(ii) Write down the equation of the line of symmetry of  $y = h(x)$ .

..... [1]

(iii) Solve  $f(x) > h(x)$ .

..... [2]

3 Alana and Bill share some money in the ratio 5 : 4.  
Alana's share is \$160.

(a) Show that Bill's share is \$128.

[1]

(b) Alana spends \$ $x$ .  
The ratio of Alana's money : Bill's money is now 4 : 5.

Find the value of  $x$ .

$x = \dots\dots\dots$  [3]

(c) A shop has a sale.  
Bill buys a jacket in the sale for \$32.

(i) Write \$32 as a percentage of \$128.

$\dots\dots\dots\%$  [1]

(ii) The original price of the jacket was reduced by 20% to \$32.

Work out the original price.

\$ $\dots\dots\dots$  [3]

4 (a) Solve the following equations.

(i)  $2x - 3 = -11$

$x = \dots\dots\dots$  [2]

(ii)  $\frac{36}{x} = -4$

$x = \dots\dots\dots$  [2]

(iii)  $6x + 13 = 17 - 2x$

$x = \dots\dots\dots$  [2]

(b) Solve the simultaneous equations.  
You must show all your working.

$$5x + 3y = -19$$

$$3x + 5y = -21$$

$x = \dots\dots\dots$

$y = \dots\dots\dots$  [4]

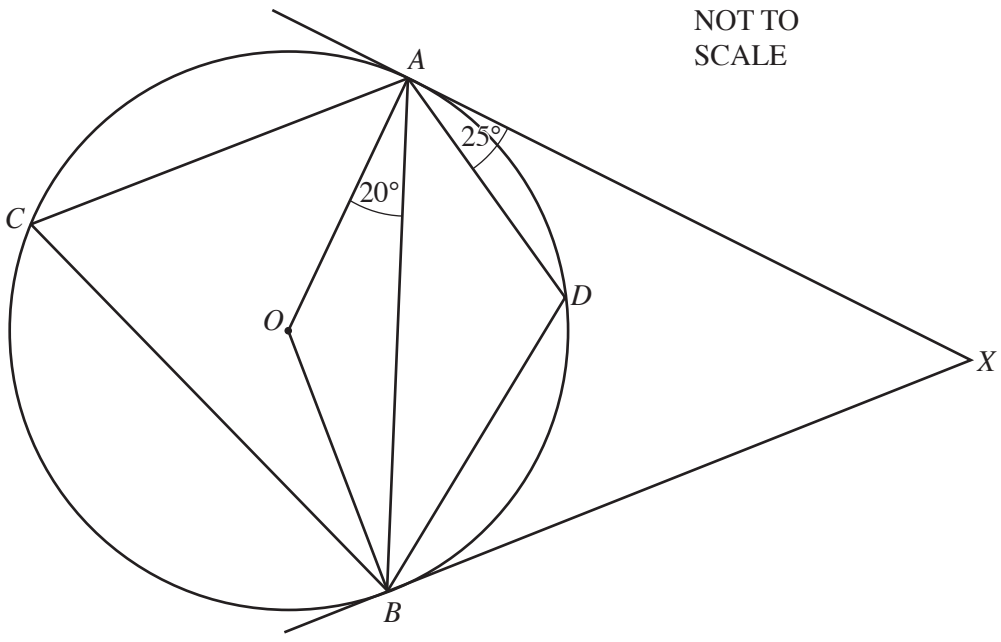

$A, B, C$  and  $D$  lie on a circle, centre  $O$ .  
 $AX$  is a tangent to the circle at  $A$  and  $BX$  is a tangent to the circle at  $B$ .  
 Angle  $OAB = 20^\circ$  and angle  $DAX = 25^\circ$ .

(a) Find the value of

(i) angle  $AOB$ ,

Angle  $AOB = \dots\dots\dots$  [2]

(ii) angle  $ACB$ ,

Angle  $ACB = \dots\dots\dots$  [1]

(iii) angle  $ADB$ ,

Angle  $ADB = \dots\dots\dots$  [1]



(iv) angle  $BAD$ ,

Angle  $BAD$  = ..... [1]

(v) angle  $DBA$ ,

Angle  $DBA$  = ..... [1]

(vi) angle  $AXB$ .

Angle  $AXB$  = ..... [1]

(b) What type of quadrilateral is  $ACBD$ ?

..... [1]

- 6 Spinner A is numbered 1, 2, 3, 4.  
Spinner B is numbered 1, 2, 3, 4, 5, 6.  
Each spinner is equally likely to land on any of its numbers.  
The two spinners are each spun once and the number that each spinner lands on is recorded.

Find the probability that

- (a) the number on spinner A is greater than 4,

..... [1]

- (b) the number on spinner B is not a 3,

..... [1]

- (c) the number on spinner A is the same as the number on spinner B,

..... [2]

- (d) one number is odd and one number is even,

..... [3]

- (e) the sum of the numbers is 6.

..... [2]

7 (a) (i) Factorise  $2x^2 - 11x - 6$ .

..... [2]

(ii) Using your answer to **part (i)**, solve  $2x^2 - 11x - 6 < 0$ .

..... [2]

(b) Solve the equation  $3x^2 - x - 5 = 0$ .

Give your answers correct to 2 decimal places.  
You must show all your working.

$x = \dots\dots\dots$  or  $x = \dots\dots\dots$  [3]

- 8 There are 100 students in a year group.  
Each student studies at least one of the languages, French ( $F$ ), Italian ( $I$ ) and Spanish ( $S$ ).

$x$  students study all 3 languages.

$y$  students study French only.

18 students study Italian only.

4 students study French and Italian but not Spanish.

12 students study French and Spanish but not Italian.

2 students study Italian and Spanish but not French.

74 students study only one language.

- (a) Show this information on the Venn diagram.

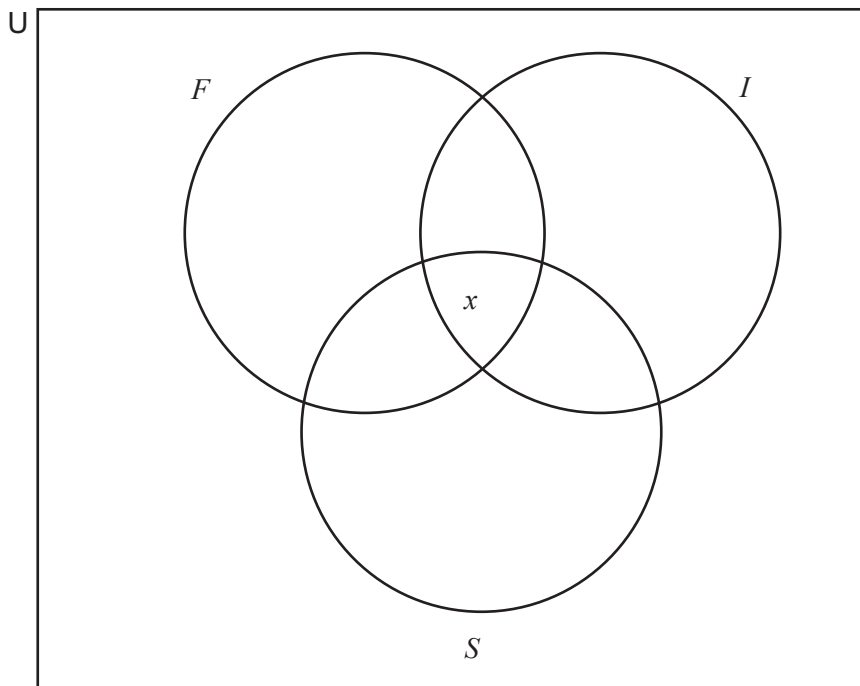

[2]

- (b) Twice as many students study French as Italian.

Find the number of students who study

- (i) all 3 subjects,

$$x = \dots\dots\dots [2]$$

- (ii) French only,

$$y = \dots\dots\dots [2]$$

- (iii) Spanish only.

$$\dots\dots\dots [1]$$

9

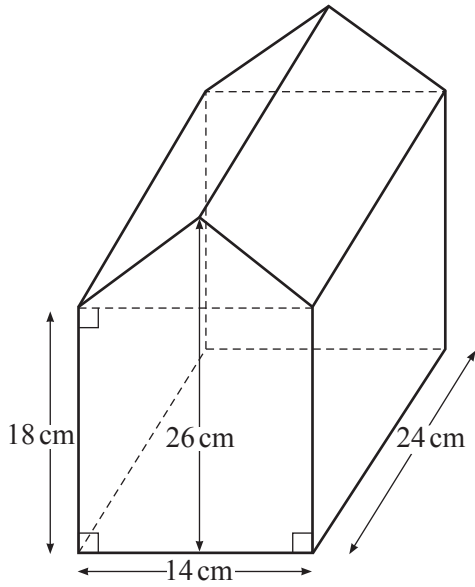

NOT TO SCALE

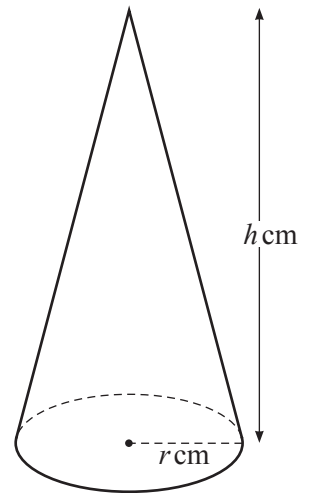
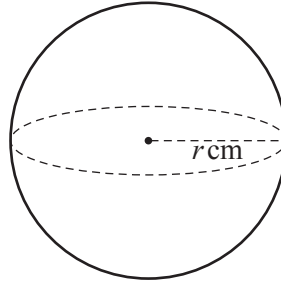

The diagram shows three solids, a prism, a sphere and a cone.  
The radius of the sphere is equal to the base radius of the cone.  
The volume of each solid is the same.

(a) Show that the volume of the prism is  $7392 \text{ cm}^3$ .

[3]

- (b) A similar prism has a volume of  $924 \text{ cm}^3$ .  
The length of the original prism is 24 cm.

Find the length of this similar prism.

..... cm [3]

- (c) Find the value of  $r$ .

$r =$  ..... [2]

- (d) Find the value of  $h$ .

$h =$  ..... [2]

- (e) When exact values of  $h$  and  $r$  are used,  $h = 4r$ .

Find, in terms of  $r$ , an exact expression for the curved surface area of the cone.  
Give your answer in its simplest form.

..... [3]

- 10 The mass of each of 80 apples is shown in the table.

Mass ( $m$ grams)	Frequency
$0 < m \leq 100$	6
$100 < m \leq 120$	22
$120 < m \leq 140$	31
$140 < m \leq 160$	13
$160 < m \leq 250$	8

- (a) Calculate an estimate of the mean mass of an apple.

..... g [2]

- (b) Find the interval which contains the upper quartile.

.....  $< m \leq$  ..... [1]

- (c) Two of these apples are chosen at random.

Find the probability that they both have a mass of 120 g or less.  
Give your answer as a fraction in its simplest form.

..... [3]



(d) (i) Complete the frequency density column in this table.

Mass ( $m$ grams)	Frequency	Frequency density
$0 < m \leq 100$	6	
$100 < m \leq 120$	22	
$120 < m \leq 140$	31	
$140 < m \leq 160$	13	
$160 < m \leq 250$	8	

[2]

(ii) On the grid, draw a histogram to show this information.

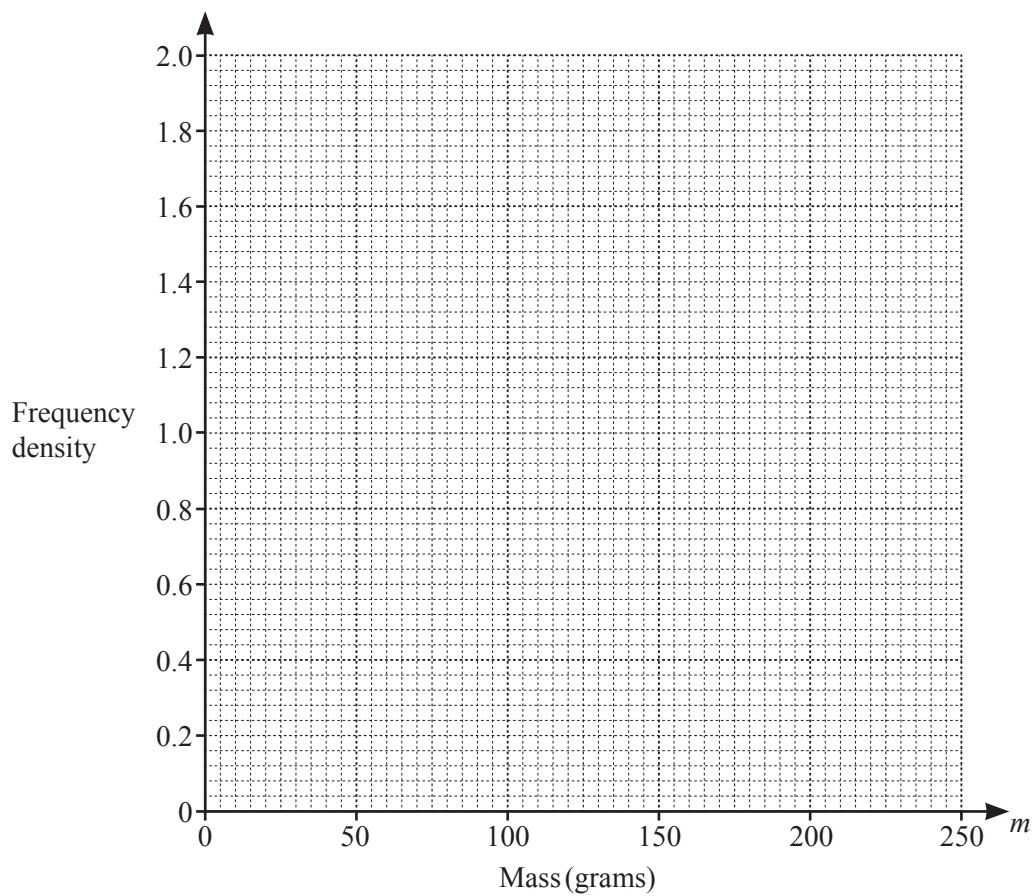

[3]

11

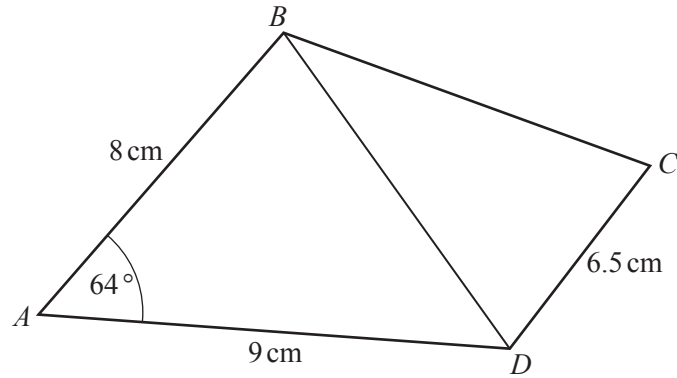
NOT TO  
SCALE

The diagram shows a quadrilateral  $ABCD$ .

$AB = 8\text{ cm}$ ,  $AD = 9\text{ cm}$ ,  $CD = 6.5\text{ cm}$  and angle  $BAD = 64^\circ$ .

- (a) Calculate  $BD$  and show that your answer rounds to  $9.05\text{ cm}$ , correct to 2 decimal places.

[2]

- (b) The area of the quadrilateral  $ABCD$  is  $57.3\text{ cm}^2$ .

- (i) Calculate angle  $BDC$  and show that your answer rounds to  $58^\circ$ , correct to the nearest degree.

[4]

- (ii) Calculate angle  $BCD$ .

angle  $BCD = \dots\dots\dots$  [5]

**Question 12 is printed on the next page.**

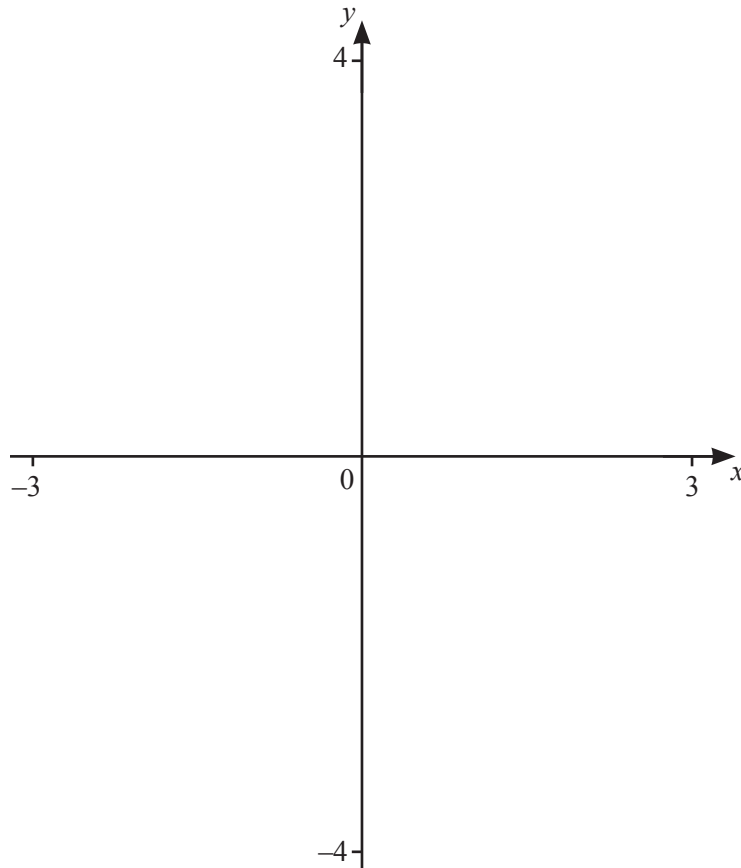

(a) On the diagram, sketch the graph of  $y = f(x)$ , where

$$f(x) = \frac{1}{x(x-1)(x+1)} \quad \text{for values of } x \text{ between } -3 \text{ and } 3.$$

[4]

(b) Write down the equations of the asymptotes.

....., ....., ....., ..... [3]

(c) Write down the co-ordinates of the local maximum.

(....., .....) [2]

(d) The line  $y = 2x + 1$  intersects the curve  $y = f(x)$  twice.

Find the value of the  $x$  co-ordinate of each point of intersection.

$x = \dots\dots\dots$  or  $x = \dots\dots\dots$  [2]

Permission to reproduce items where third-party owned material protected by copyright is included has been sought and cleared where possible. Every reasonable effort has been made by the publisher (UCLES) to trace copyright holders, but if any items requiring clearance have unwittingly been included, the publisher will be pleased to make amends at the earliest possible opportunity.

To avoid the issue of disclosure of answer-related information to candidates, all copyright acknowledgements are reproduced online in the Cambridge Assessment International Education Copyright Acknowledgements Booklet. This is produced for each series of examinations and is freely available to download at [www.cambridgeinternational.org](http://www.cambridgeinternational.org) after the live examination series.

Cambridge Assessment International Education is part of the Cambridge Assessment Group. Cambridge Assessment is the brand name of the University of Cambridge Local Examinations Syndicate (UCLES), which itself is a department of the University of Cambridge.