

Candidate surname

Other names

**Pearson Edexcel
Level 3 GCE**

Centre Number

--	--	--	--	--

Candidate Number

--	--	--	--

--

**AS and A level Further Mathematics
Decision Mathematics 1**

**Practice Paper
Dijkstra and Floyd**

Answer Book

Do not return the question paper with the answer book.

Total Marks

--

1. (a)

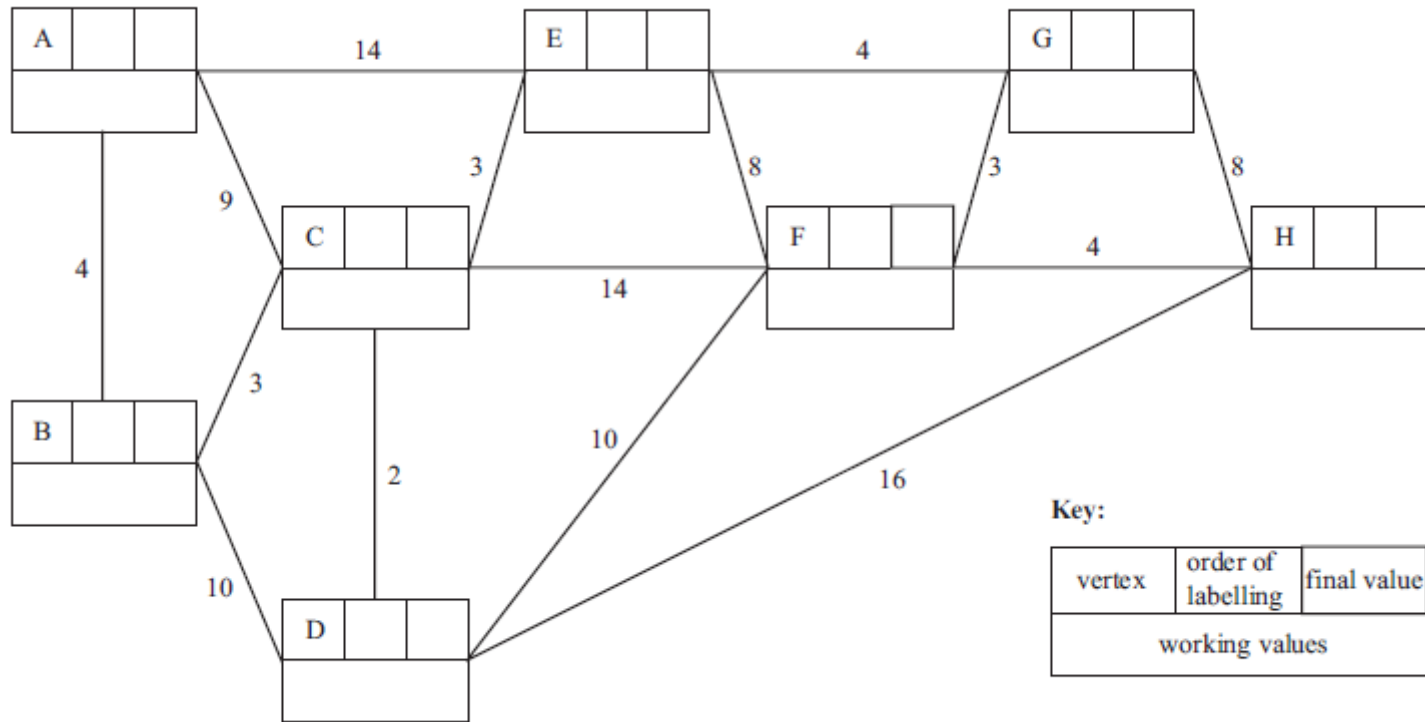

Shortest distance A to H

Question 1 continued

(b)

.....

.....

.....

.....

.....

.....

.....

.....

(c)

.....

.....

.....

.....

.....

.....

.....

.....

(Total 8 marks)

2.

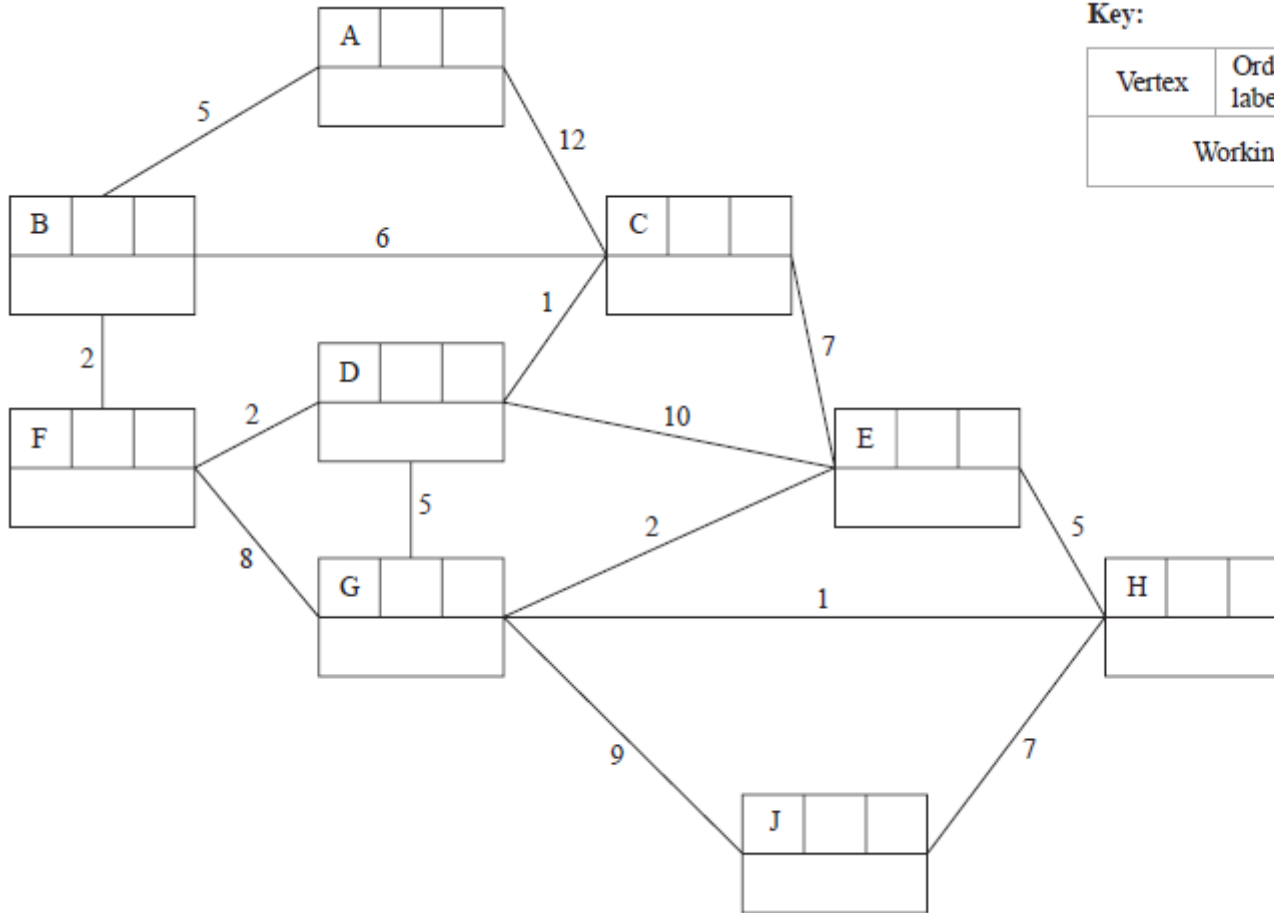

Key:

Vertex	Order of labelling	Final value
Working values		

Shortest route

Length of shortest route

Question 2 continued

.....

.....

.....

.....

.....

.....

.....

.....

.....

.....

.....

.....

.....

.....

.....

.....

.....

.....

.....

.....

.....

.....

(Total 10 marks)

3. (a)

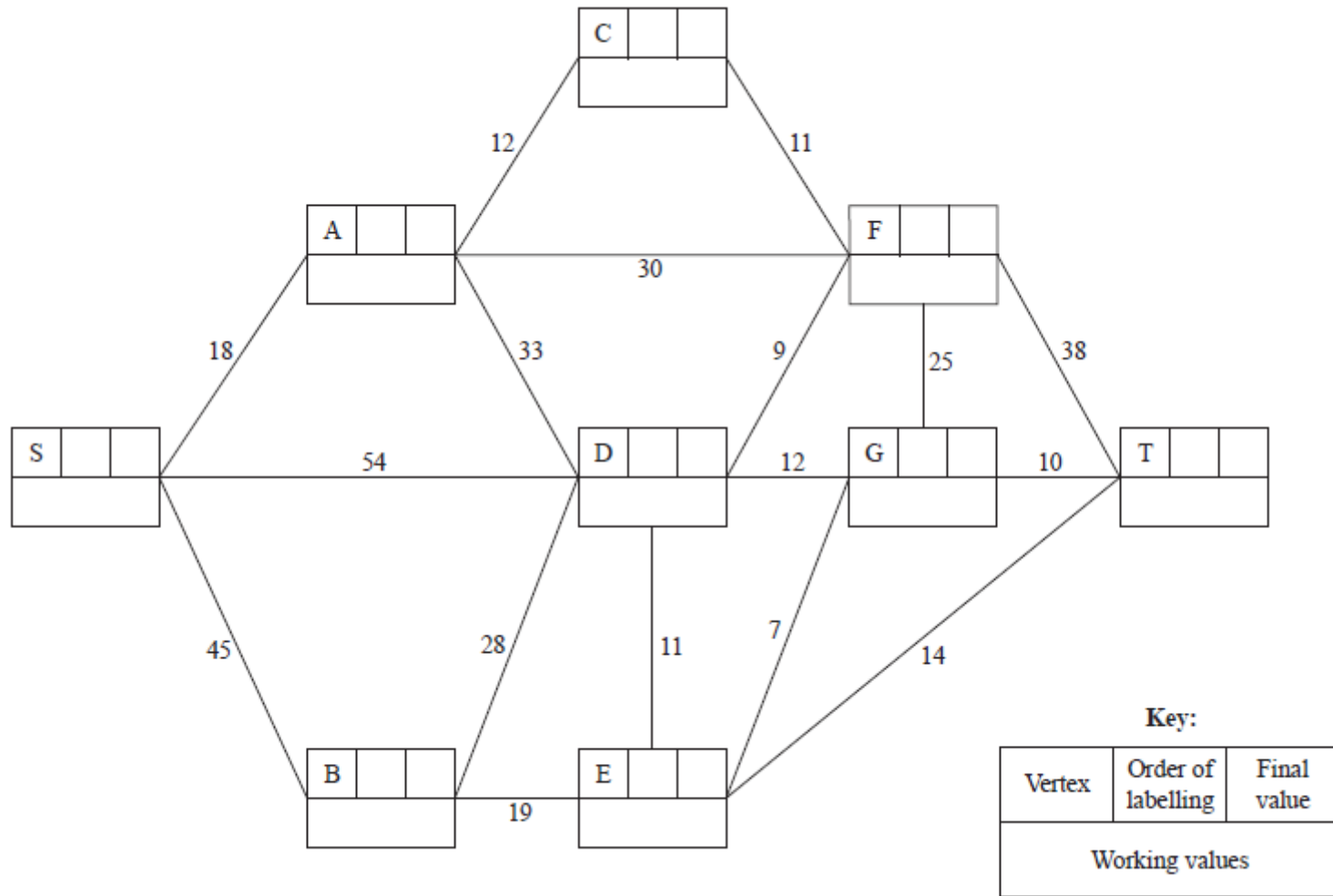

Question 3 continued

.....
.....
.....
.....

Quickest route from S to T

Time of quickest route from S to T

(b)

.....
.....
.....
.....
.....
.....
.....
.....
.....
.....

(Total 9 marks)

4. (a)

.....

(b)

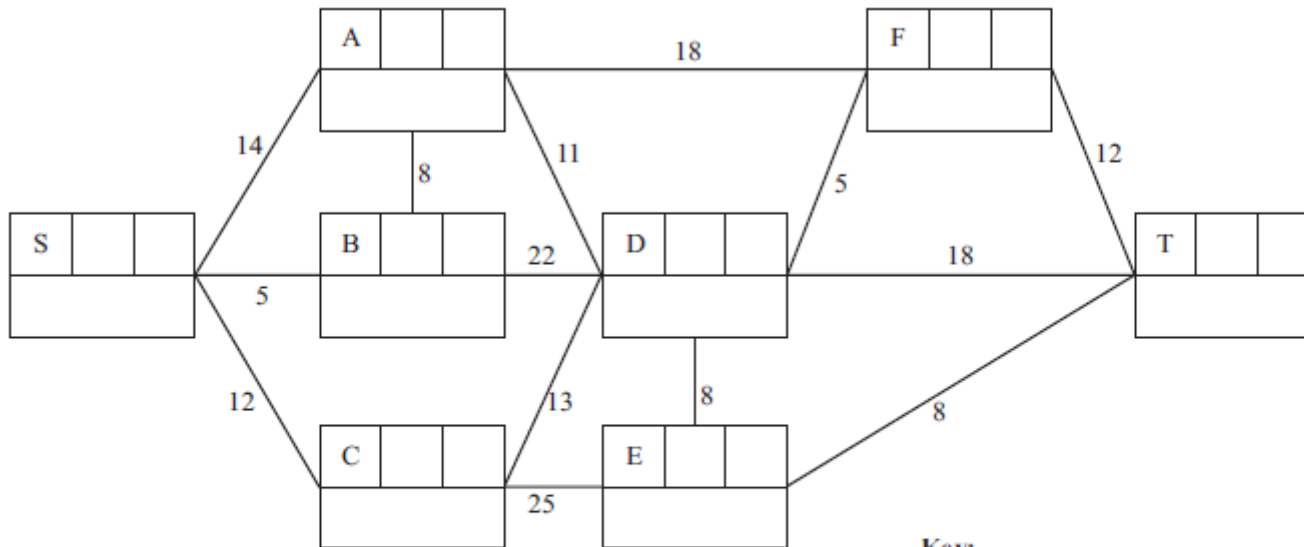

Key:

Vertex	Order of labelling	Final value
Working value		

Shortest path

Length of shortest path

Question 4 continued

(c)

Shortest distance from S to F

(d)

.....

.....

.....

.....

.....

.....

.....

.....

.....

.....

.....

.....

.....

.....

.....

.....

.....

.....

.....

.....

.....

.....

(Total 11 marks)

5.

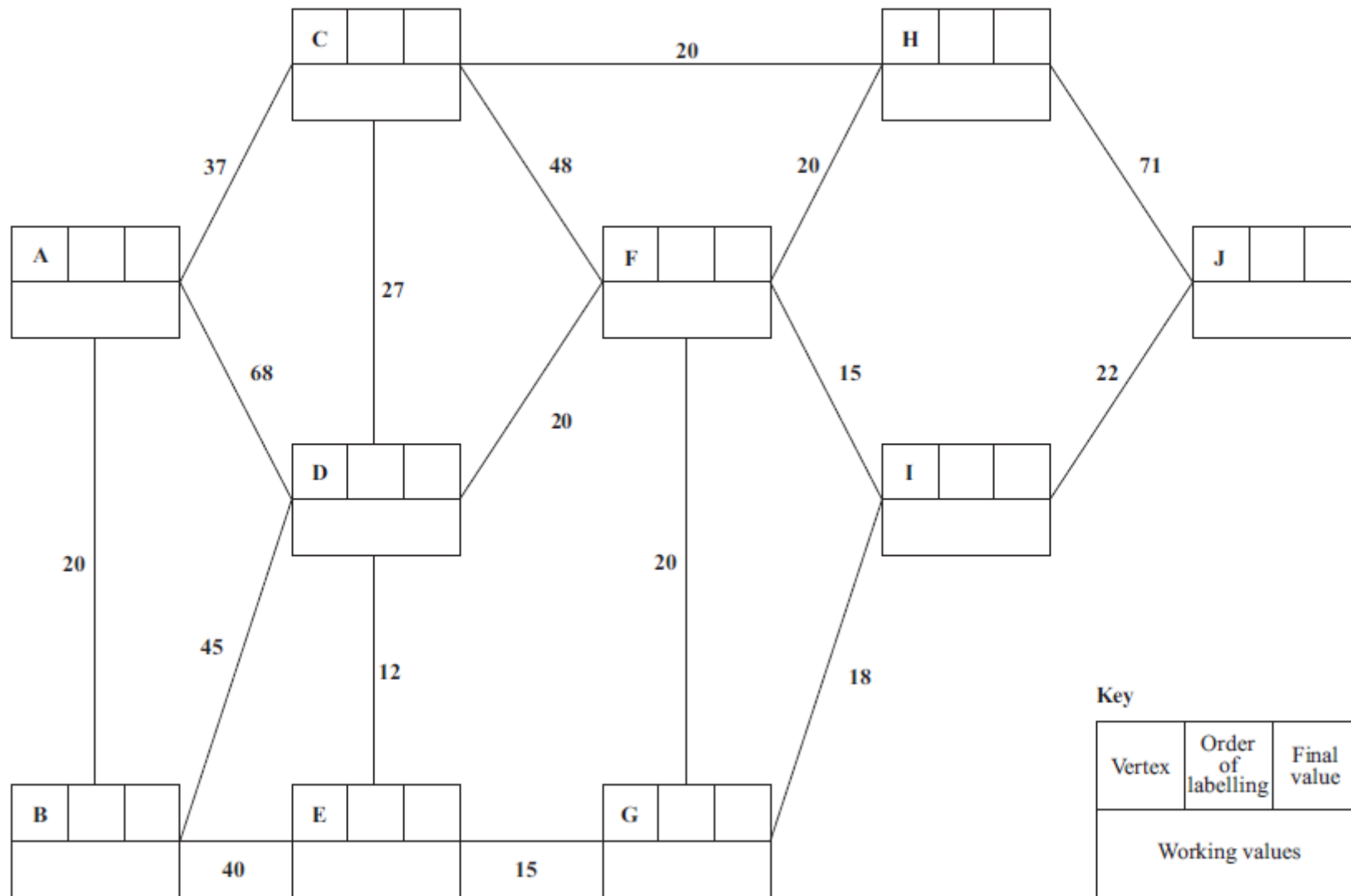

Key

Vertex	Order of labelling	Final value
Working values		

Question 5 continued

.....

.....

.....

.....

.....

.....

.....

.....

.....

.....

.....

.....

.....

.....

.....

.....

.....

.....

.....

.....

.....

.....

(Total 9 marks)



6. (a)

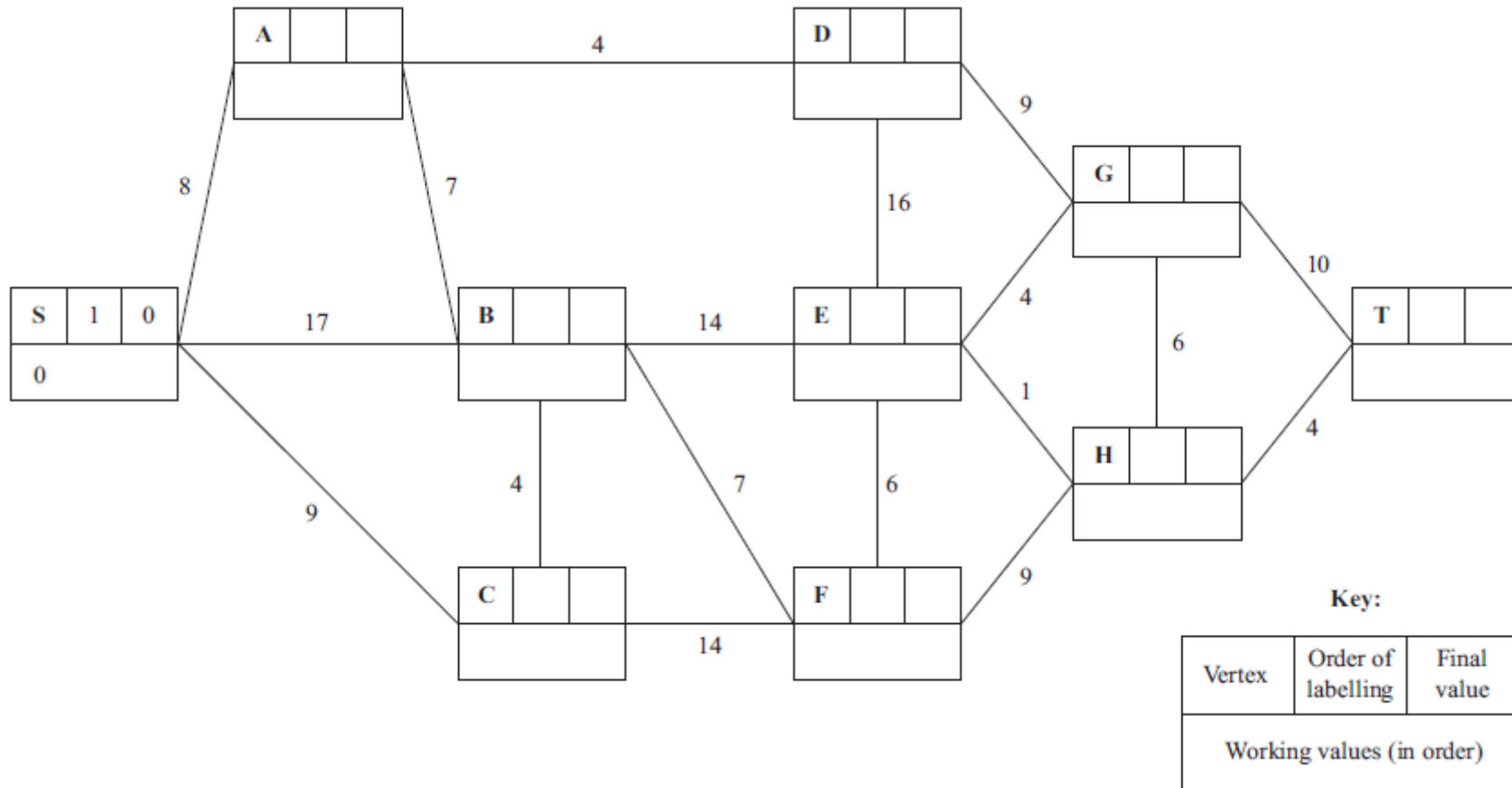

Question 6 continued

Shortest path from S to T

Length of shortest path from S to T

(b)

.....
.....
.....
.....
.....

Shortest path from S to T via F

Length of the shortest path from S to T via F

(Total 8 marks)

7.

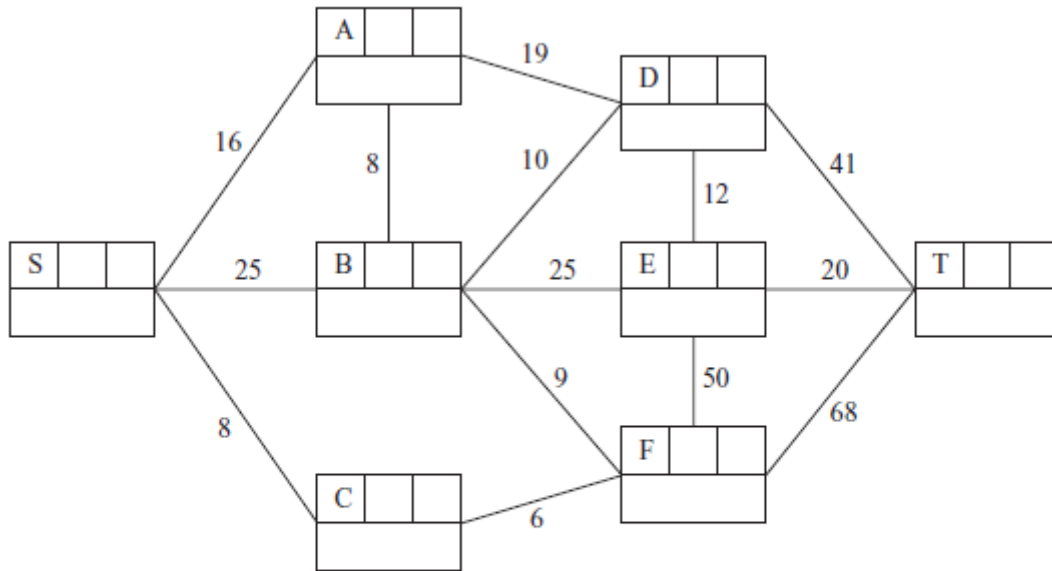

Key:

Vertex	Order of labelling	Final value
Working values		

Shortest route

Length of shortest route

Question 7 continued

.....

.....

.....

.....

.....

.....

.....

.....

.....

.....

.....

.....

.....

.....

.....

.....

.....

.....

.....

(Total 10 marks)

8.

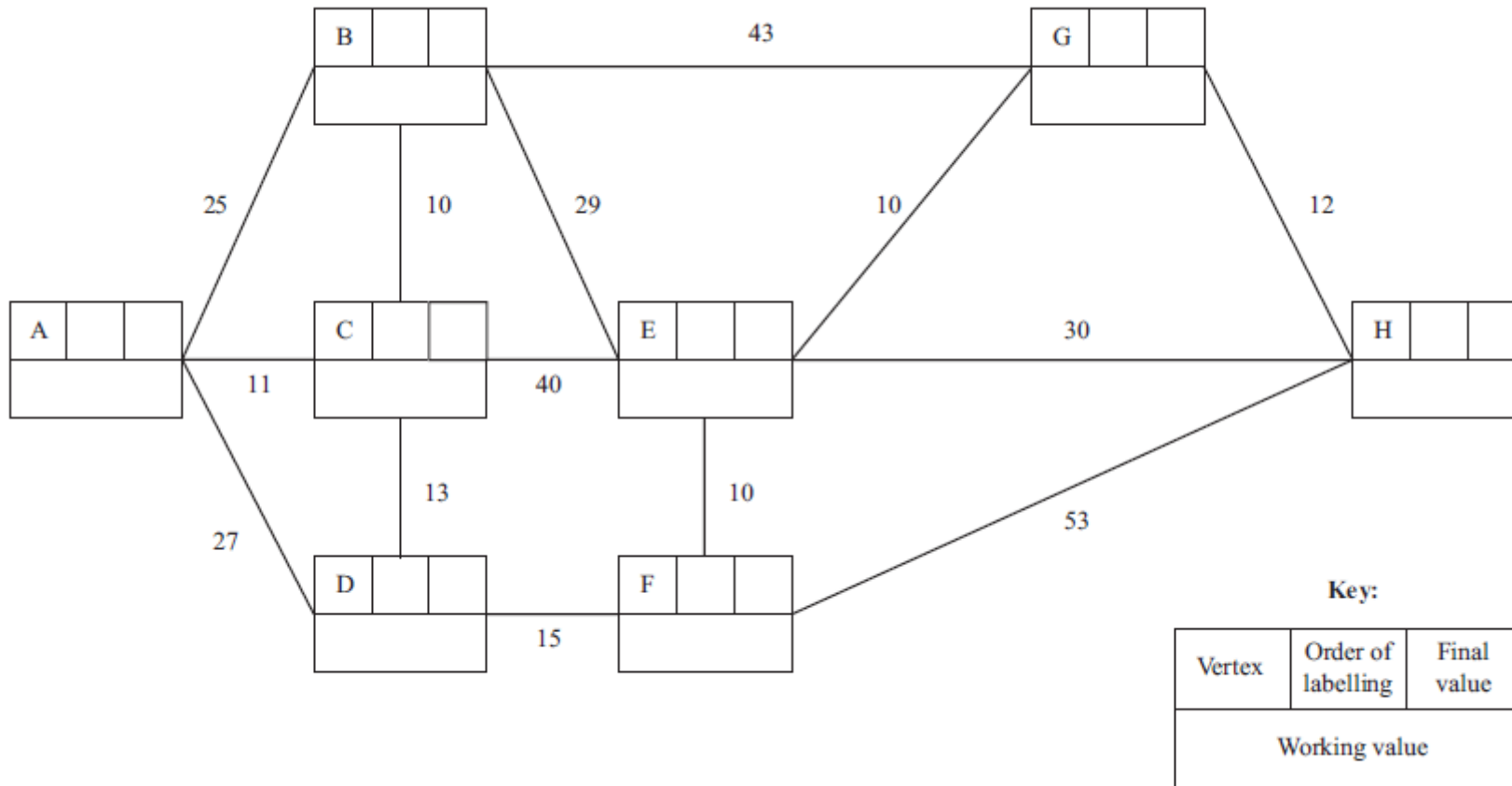

Question 8 continued

Shortest route

Length of shortest route

.....

.....

.....

.....

.....

.....

.....

.....

.....

.....

.....

.....

.....

.....

.....

.....

.....

.....

.....

.....

.....

.....

(Total 10 marks)

9.

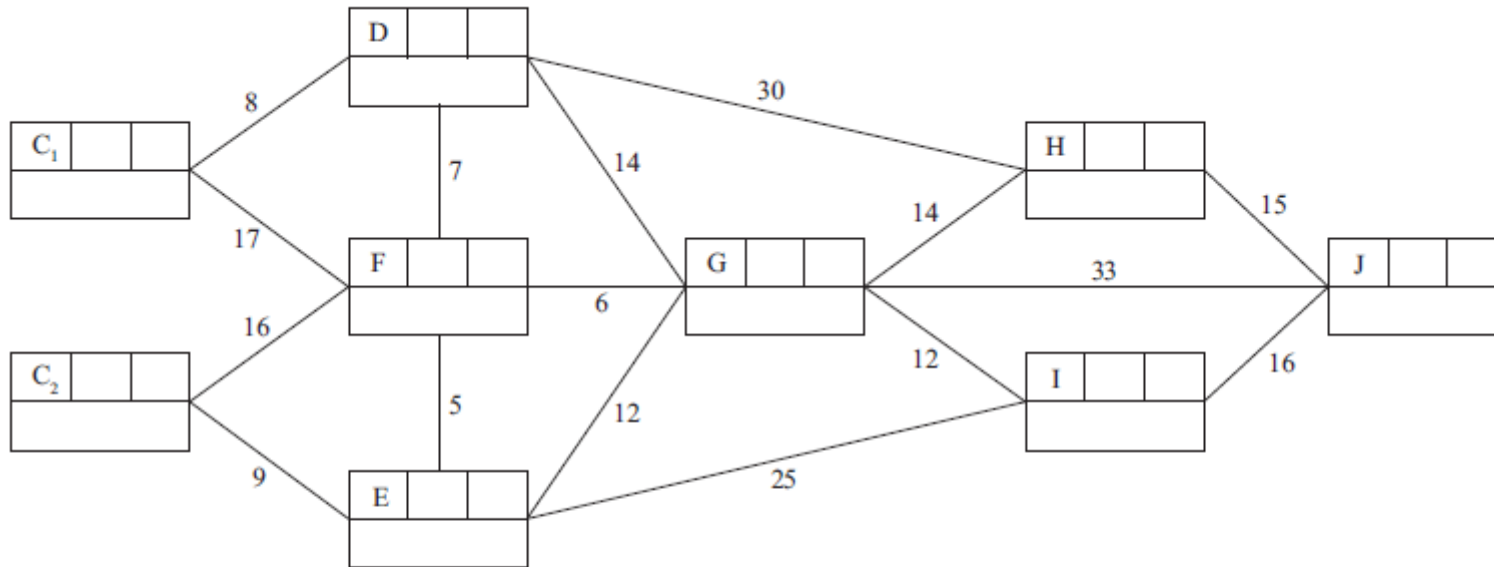

Key

Vertex	Order of labelling	Final value
Working values		

Question 9 continued

.....

.....

.....

.....

.....

.....

.....

.....

.....

.....

.....

.....

.....

.....

.....

.....

Shortest route

Length of shortest route

(Total 7 marks)

TOTAL FOR PAPER: 82 MARKS