

Centre Number						Candidate Number				
Surname										
Other Names										
Candidate Signature										



General Certificate of Education
Advanced Level Examination
June 2013

Mathematics

MPC3

Unit Pure Core 3

Thursday 6 June 2013 9.00 am to 10.30 am

For this paper you must have:

- the blue AQA booklet of formulae and statistical tables.
- You may use a graphics calculator.

Time allowed

- 1 hour 30 minutes

- Instructions**
- Use black ink or black ball-point pen. Pencil should only be used for drawing.
 - Fill in the boxes at the top of this page.
 - Answer **all** questions.
 - Write the question part reference (eg (a), (b)(i) etc) in the left-hand margin.
 - You must answer each question in the space provided for that question. If you require extra space, use an AQA supplementary answer book; do **not** use the space provided for a different question.
 - Do not write outside the box around each page.
 - Show all necessary working; otherwise marks for method may be lost.
 - Do all rough work in this book. Cross through any work that you do not want to be marked.

- Information**
- The marks for questions are shown in brackets.
 - The maximum mark for this paper is 75.

- Advice**
- Unless stated otherwise, you may quote formulae, without proof, from the booklet.
 - You do not necessarily need to use all the space provided.

For Examiner's Use	
Examiner's Initials	
Question	Mark
1	
2	
3	
4	
5	
6	
7	
8	
9	
10	
TOTAL	



Answer **all** questions.

Answer each question in the space provided for that question.

1 The diagram below shows the graphs of $y = |2x - 3|$ and $y = |x|$.

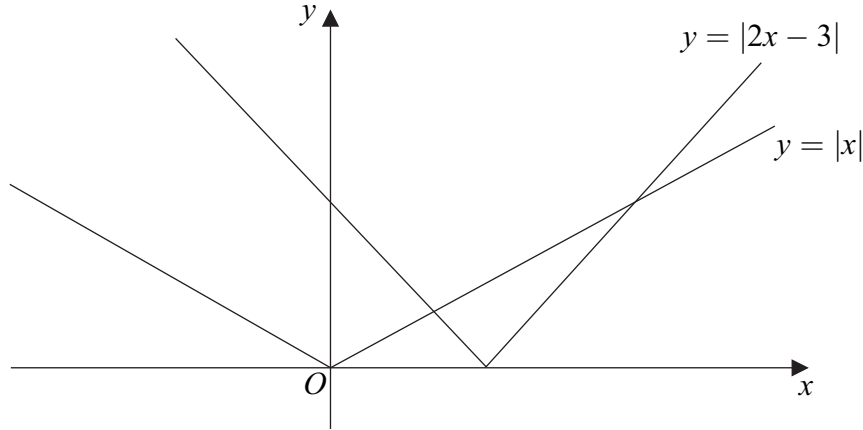

(a) Find the x -coordinates of the points of intersection of the graphs of $y = |2x - 3|$ and $y = |x|$. (3 marks)

(b) Hence, or otherwise, solve the inequality

$$|2x - 3| \geq |x| \quad (2 \text{ marks})$$

QUESTION
PART
REFERENCE

Answer space for question 1

.....

.....

.....

.....

.....

.....

.....

.....

.....

.....

.....



QUESTION
PART
REFERENCE

Answer space for question 1

Handwriting practice area with horizontal dotted lines.

Turn over ►



2 (a) Given that $y = x^4 \tan 2x$, find $\frac{dy}{dx}$. (3 marks)

(b) Find the gradient of the curve with equation $y = \frac{x^2}{x-1}$ at the point where $x = 3$. (3 marks)

QUESTION
PART
REFERENCE

Answer space for question 2



QUESTION
PART
REFERENCE

Answer space for question 2

A large rectangular area with horizontal dotted lines for writing an answer.



Turn over ▶

3 (a) The equation $e^{-x} - 2 + \sqrt{x} = 0$ has a single root, α .

Show that α lies between 3 and 4. (2 marks)

(b) Use the recurrence relation $x_{n+1} = (2 - e^{-x_n})^2$, with $x_1 = 3.5$, to find x_2 and x_3 , giving your answers to three decimal places. (2 marks)

(c) The diagram on the opposite page shows parts of the graphs of $y = (2 - e^{-x})^2$ and $y = x$, and a position of x_1 .

On the diagram, draw a staircase or cobweb diagram to show how convergence takes place, indicating the positions of x_2 and x_3 on the x -axis. (2 marks)

QUESTION
PART
REFERENCE

Answer space for question 3



QUESTION
PART
REFERENCE

Answer space for question 3

Area with horizontal dotted lines for writing the answer.

(c)

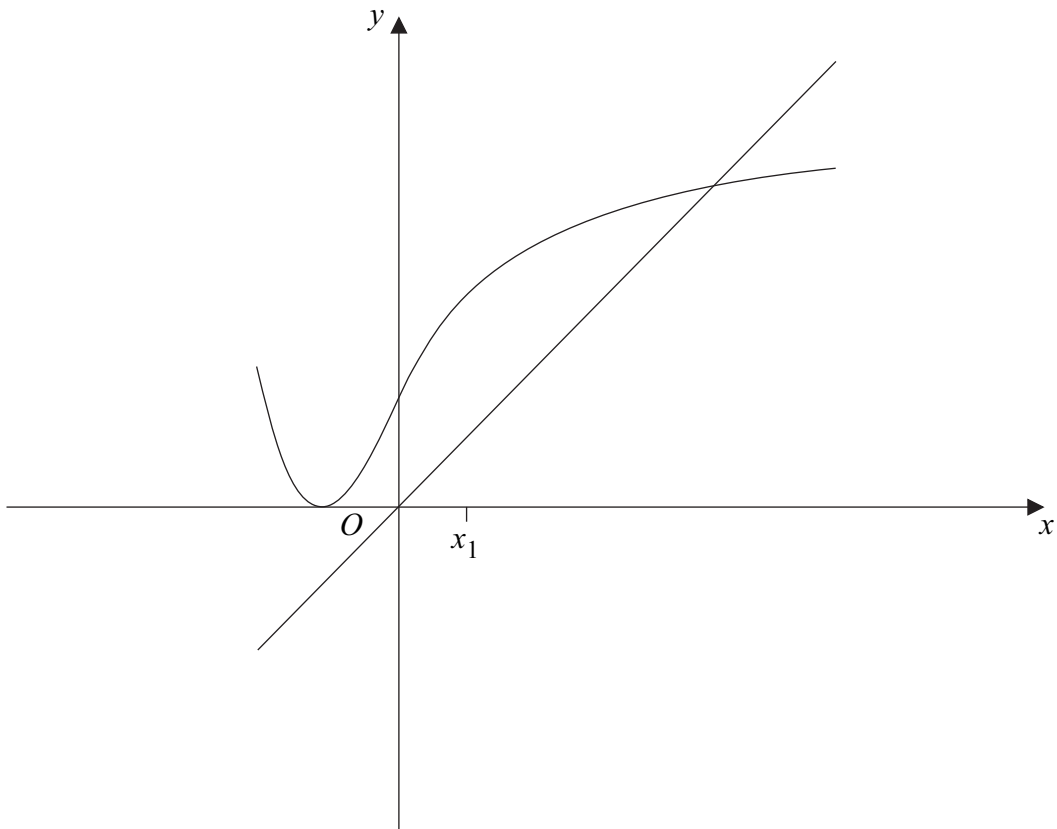

Turn over ►



4 By forming and solving a quadratic equation, solve the equation

$$8 \sec x - 2 \sec^2 x = \tan^2 x - 2$$

in the interval $0 < x < 2\pi$, giving the values of x in radians to three significant figures. (7 marks)

QUESTION
PART
REFERENCE

Answer space for question 4



QUESTION
PART
REFERENCE

Answer space for question 4

Handwriting practice area with horizontal dotted lines.



Turn over ►

5

The diagram shows a sketch of the graph of $y = \sqrt{27 + x^3}$.

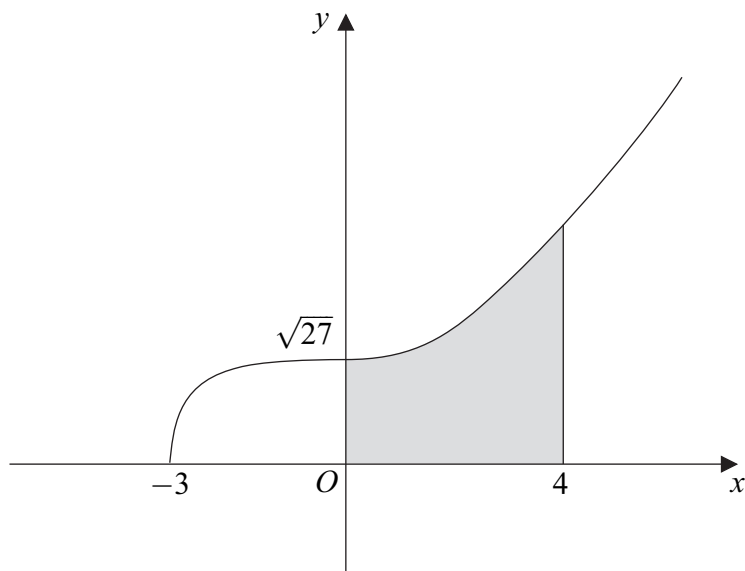

- (a) The area of the shaded region, bounded by the curve, the x -axis and the lines $x = 0$ and $x = 4$, is given by $\int_0^4 \sqrt{27 + x^3} dx$.

Use the mid-ordinate rule with **five** strips to find an estimate for this area. Give your answer to three significant figures. (4 marks)

- (b) With the aid of a diagram, explain whether the mid-ordinate rule applied in part (a) gives an estimate which is smaller than or greater than the area of the shaded region. (2 marks)

QUESTION
PART
REFERENCE

Answer space for question 5

.....

.....

.....

.....

.....

.....

.....

.....

.....

.....

.....



QUESTION
PART
REFERENCE

Answer space for question 5

A large rectangular area with horizontal dotted lines for writing an answer.

Turn over ►



- 6 (a)** Sketch the graph of $y = \cos^{-1} x$, where y is in radians. State the coordinates of the end points of the graph. (2 marks)
- (b)** Sketch the graph of $y = \pi - \cos^{-1} x$, where y is in radians. State the coordinates of the end points of the graph. (2 marks)

 QUESTION
 PART
 REFERENCE

Answer space for question 6
(a)

$$y = \cos^{-1} x$$

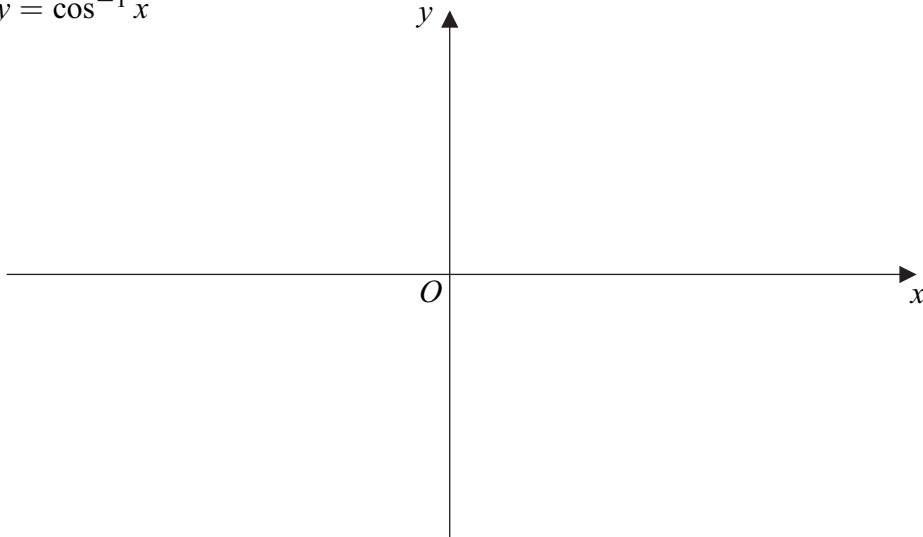
(b)

$$y = \pi - \cos^{-1} x$$

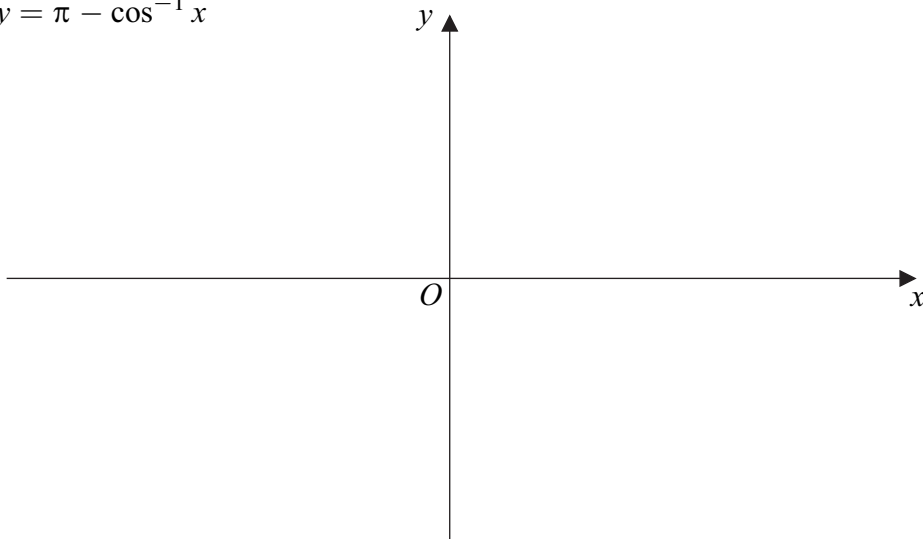

QUESTION
PART
REFERENCE

Answer space for question 6

A large rectangular area for writing an answer, containing 25 horizontal dotted lines.



Turn over ►

7

The diagram shows a sketch of the curve with equation $y = f(x)$.

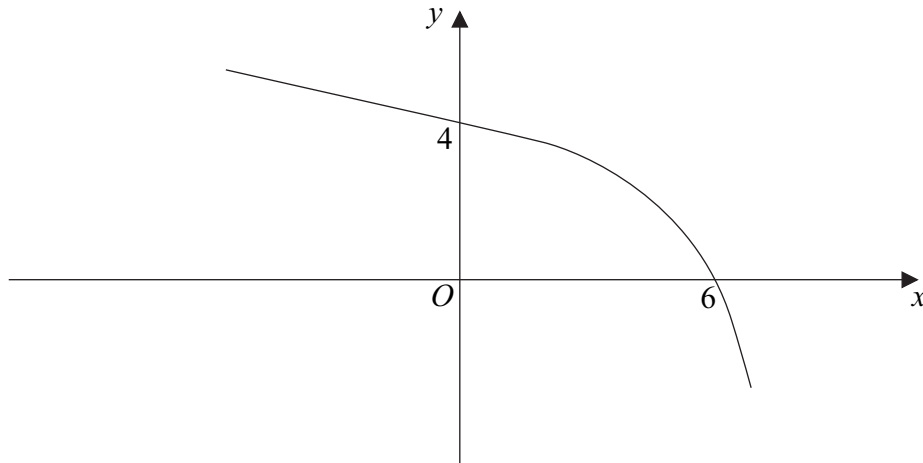

- (a) On **Figure 1**, below, sketch the curve with equation $y = -f(3x)$, indicating the values where the curve cuts the coordinate axes. (2 marks)
- (b) On **Figure 2**, on the opposite page, sketch the curve with equation $y = f(|x|)$, indicating the values where the curve cuts the coordinate axes. (3 marks)
- (c) Describe a sequence of two geometrical transformations that maps the graph of $y = f(x)$ onto the graph of $y = f\left(-\frac{1}{2}x\right)$. (4 marks)

 QUESTION
PART
REFERENCE

Answer space for question 7

(a)

$$y = -f(3x)$$

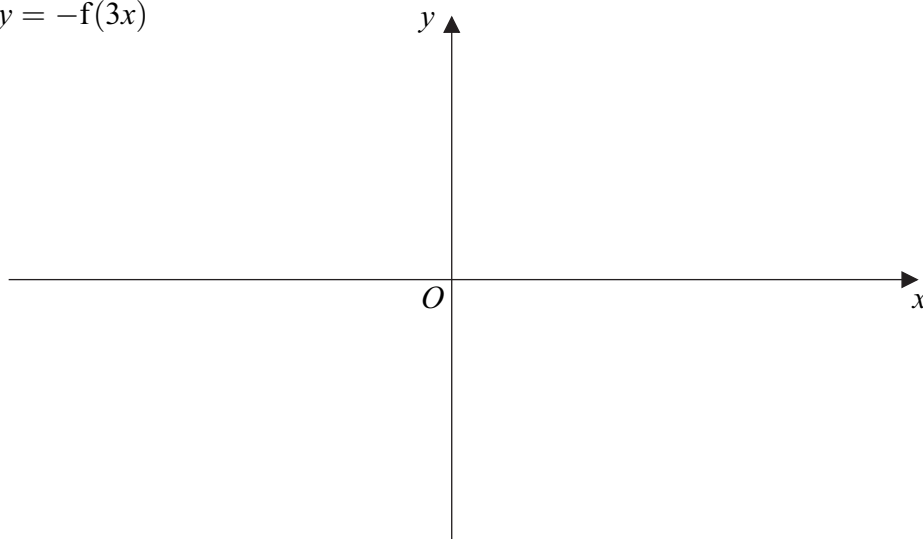
Figure 1

QUESTION
PART
REFERENCE

Answer space for question 7

(b)

$$y = f(|x|)$$

Figure 2

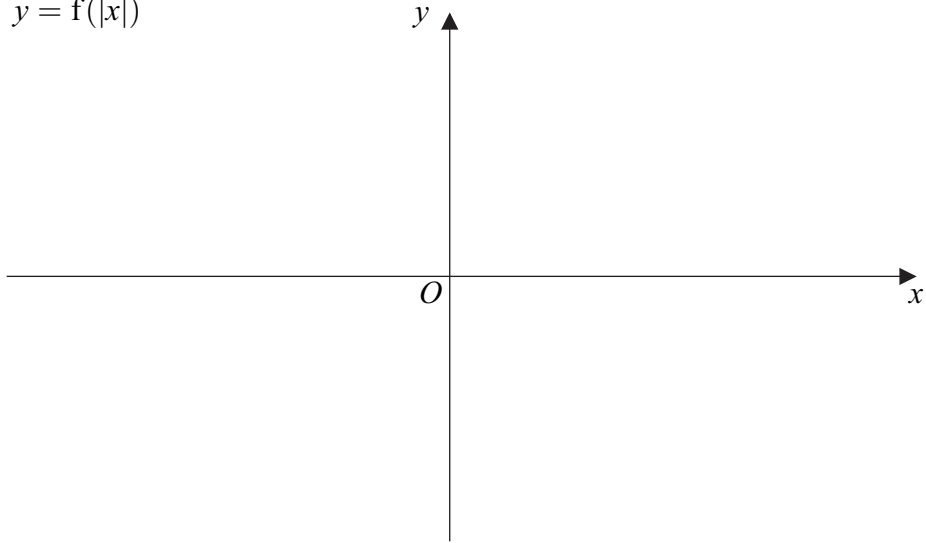

(c)

Area with horizontal dotted lines for writing answers.



- 8 The curve with equation $y = f(x)$, where $f(x) = \ln(2x - 3)$, $x > \frac{3}{2}$, is sketched below.

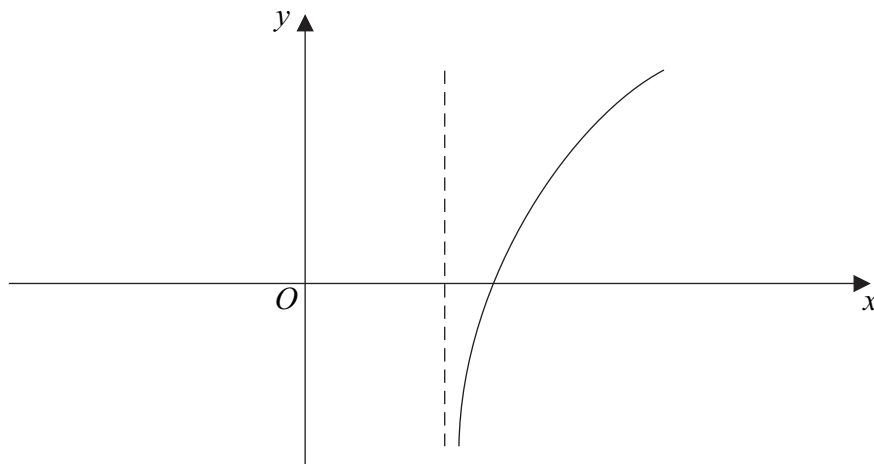

- (a) The inverse of f is f^{-1} .
- (i) Find $f^{-1}(x)$. (3 marks)
- (ii) State the range of f^{-1} . (1 mark)
- (iii) Sketch, on the axes given on the opposite page, the curve with equation $y = f^{-1}(x)$, indicating the value of the y -coordinate of the point where the curve intersects the y -axis. (2 marks)
- (b) The function g is defined by
- $$g(x) = e^{2x} - 4, \quad \text{for all real values of } x$$
- (i) Find $gf(x)$, giving your answer in the form $(ax - b)^2 - c$, where a , b and c are integers. (3 marks)
- (ii) Write down an expression for $fg(x)$, and hence find the exact solution of the equation $fg(x) = \ln 5$. (3 marks)

 QUESTION
PART
REFERENCE

Answer space for question 8

QUESTION
PART
REFERENCE

Answer space for question 8

.....

.....

.....

.....

.....

.....

.....

.....

.....

.....

.....

.....

.....

.....

.....

.....

.....

.....

.....

.....

.....

.....

.....

(a)(iii)

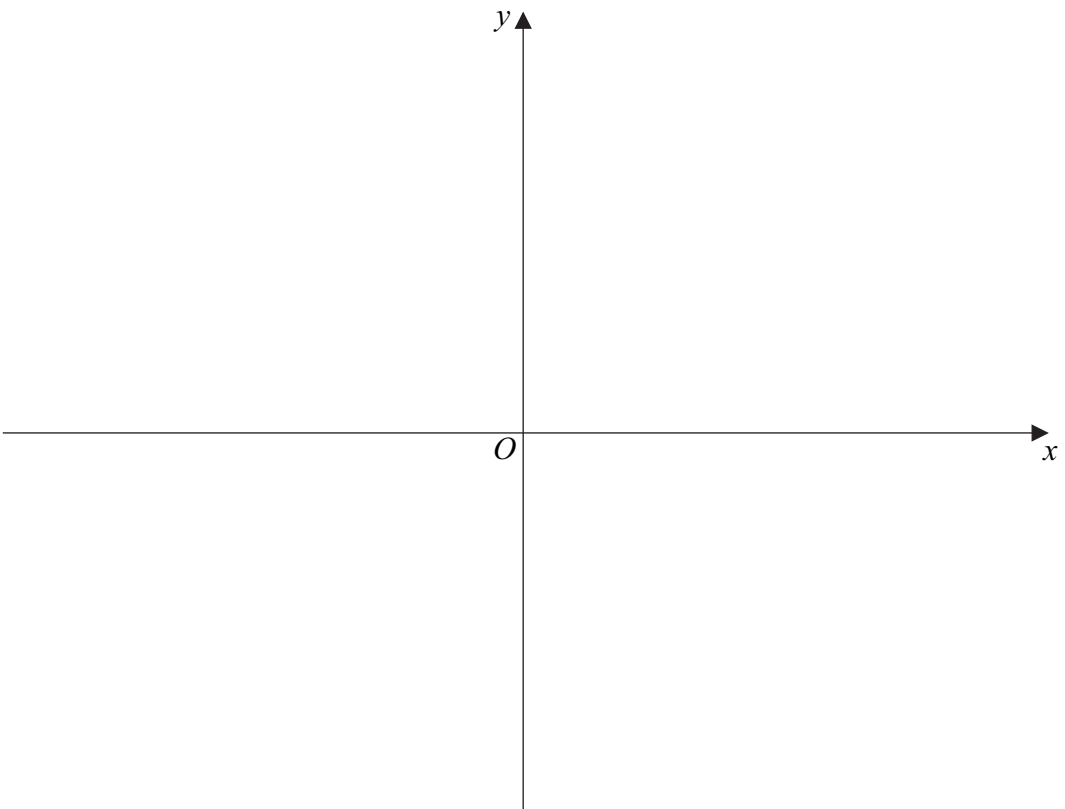

Turn over ►

QUESTION
PART
REFERENCE

Answer space for question 8

A large rectangular area with horizontal dotted lines for writing the answer to question 8.



QUESTION
PART
REFERENCE

Answer space for question 8

A large rectangular area containing 20 horizontal dotted lines for writing the answer to question 8.

Turn over ►



9

The shape of a vase can be modelled by rotating the curve with equation $16x^2 - (y - 8)^2 = 32$ between $y = 0$ and $y = 16$ completely about the y -axis.

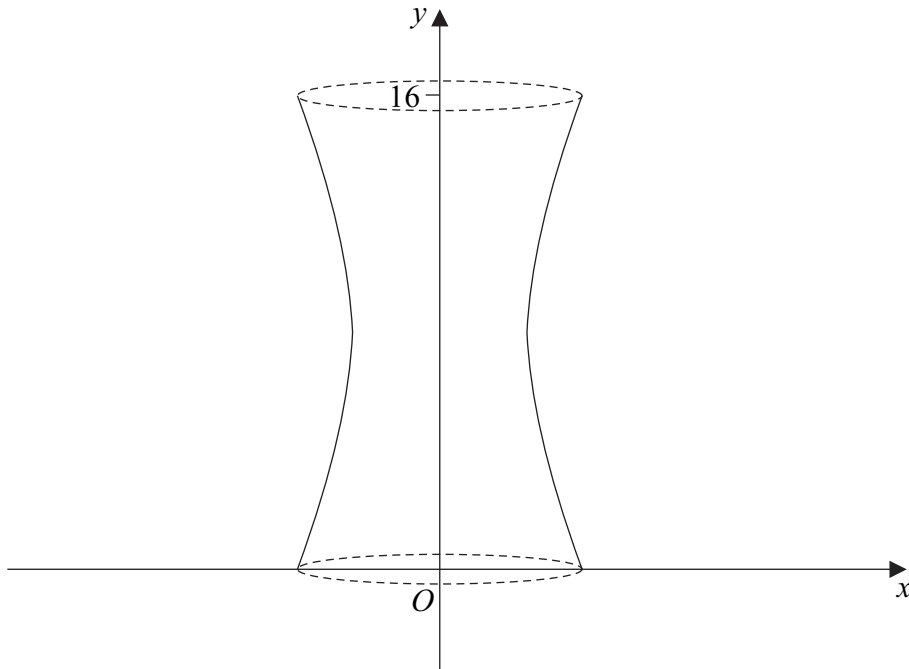

The vase has a base.

Find the volume of water needed to fill the vase, giving your answer as an exact value. (5 marks)

QUESTION PART REFERENCE

Answer space for question 9

.....

.....

.....

.....

.....

.....

.....

.....

.....

.....

.....

.....

.....

.....

.....

.....

.....

.....

.....

.....



QUESTION
PART
REFERENCE

Answer space for question 9

A large rectangular area with horizontal dotted lines for writing an answer.



Turn over ►

10 (a) (i) By writing $\ln x$ as $(\ln x) \times 1$, use integration by parts to find $\int \ln x \, dx$. (4 marks)

(ii) Find $\int (\ln x)^2 \, dx$. (4 marks)

(b) Use the substitution $u = \sqrt{x}$ to find the exact value of

$$\int_1^4 \frac{1}{x + \sqrt{x}} \, dx \quad (7 \text{ marks})$$

QUESTION
PART
REFERENCE

Answer space for question 10



QUESTION
PART
REFERENCE

Answer space for question 10

A large rectangular area with horizontal dotted lines for writing the answer.

Turn over ►



QUESTION
PART
REFERENCE

Answer space for question 10

A large rectangular area with horizontal dotted lines, intended for writing the answer to question 10.

END OF QUESTIONS

